

SMF5.0AT1 Series

Zener Transient Voltage Suppressor SOD-123 Flat Lead Package

The SMF5.0A Series is designed to protect voltage sensitive components from high voltage, high energy transients. Excellent clamping capability, high surge capability, low zener impedance and fast response time. Because of its small size, it is ideal for use in cellular phones, portable devices, business machines, power supplies and many other industrial/consumer applications.

Specification Features:

- Stand-off Voltage: 5 – 170 Volts
- Peak Power – 200 Watts @ 1 ms (SMF5.0A – SMF58A)
– 175 Watts @ 1 ms (SMF60A – SMF170A)
- Maximum Clamp Voltage @ Peak Pulse Current
- Low Leakage
- Response Time is Typically < 1 ns
- ESD Rating of Class 3 (> 16 kV) per Human Body Model
IEC61000-4-2 Level 4 ESD Protection
IEC61000-4-4 40 A ESD Protection
- Low Profile – Maximum Height of 1.0 mm
- Small Footprint – Footprint Area of 8.45 mm²
- Supplied in 8 mm Tape and Reel – 3,000 Units per Reel
- Cathode Indicated by Polarity Band

Mechanical Characteristics:

CASE: Void-free, transfer-molded, thermosetting plastic
Epoxy Meets UL94, VO

LEAD FINISH: 100% Matte Sn (Tin)

MOUNTING POSITION: Any

QUALIFIED MAX REFLOW TEMPERATURE: 260°C
Device Meets MSL 1 Requirements



ON Semiconductor®

<http://onsemi.com>

**PLASTIC SURFACE MOUNT
ZENER OVERVOLTAGE
TRANSIENT SUPPRESSOR
5 – 170 VOLTS
200 WATT PEAK POWER**

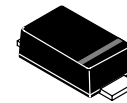
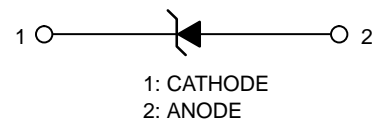

**SOD-123FL
CASE 498
PLASTIC**

MARKING DIAGRAM

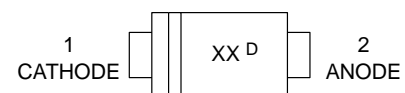

XX = Specific Device Code
D = Date Code

ORDERING INFORMATION

Device	Package	Shipping
SMFxxxAT1	SOD-123FL	3,000/Tape & Reel

LEAD ORIENTATION IN TAPE:
Cathode Lead to Sprocket Holes

SMF5.0AT1 Series

MAXIMUM RATINGS

Rating	Symbol	Value	Unit
Maximum P_{pk} Dissipation (PW=10/1000 μ s) (Note 1) SMF60A – SMF170A	P_{pk}	175	W
Maximum P_{pk} Dissipation (PW=10/1000 μ s) (Note 1) SMF5.0A – SMF58A	P_{pk}	200	W
Maximum P_{pk} Dissipation @ $T_A = 25^\circ\text{C}$, (PW=8/20 μ s) (Note 2)	P_{pk}	1000	W
DC Power Dissipation @ $T_A = 25^\circ\text{C}$ (Note 3) Derate above 25°C	P_D	385	mW
Thermal Resistance from Junction to Ambient (Note 3)	$R_{\theta JA}$	4.0	$\text{mW}/^\circ\text{C}$
Thermal Resistance from Junction to Lead (Note 3)	$R_{\theta Jcathode}$	325	$^\circ\text{C}/\text{W}$
Operating and Storage Temperature Range	T_J, T_{stg}	-55 to +150	$^\circ\text{C}$

1. Non-repetitive current pulse at $T_A = 25^\circ\text{C}$, per waveform of Figure 2.
2. Non-repetitive current pulse at $T_A = 25^\circ\text{C}$, per waveform of Figure 3.
3. Mounted with recommended minimum pad size, DC board FR-4.

ELECTRICAL CHARACTERISTICS ($T_A = 25^\circ\text{C}$ unless otherwise noted, $V_F = 3.5\text{ V Max.}$ @ I_F (Note 4) = 12 A)

Symbol	Parameter
I_{PP}	Maximum Reverse Peak Pulse Current
V_C	Clamping Voltage @ I_{PP}
V_{RWM}	Working Peak Reverse Voltage
I_R	Maximum Reverse Leakage Current @ V_{RWM}
V_{BR}	Breakdown Voltage @ I_T
I_T	Test Current
I_F	Forward Current
V_F	Forward Voltage @ I_F

4. 1/2 sine wave (or equivalent square wave), PW = 8.3 ms, duty cycle = 4 pulses per minute maximum.

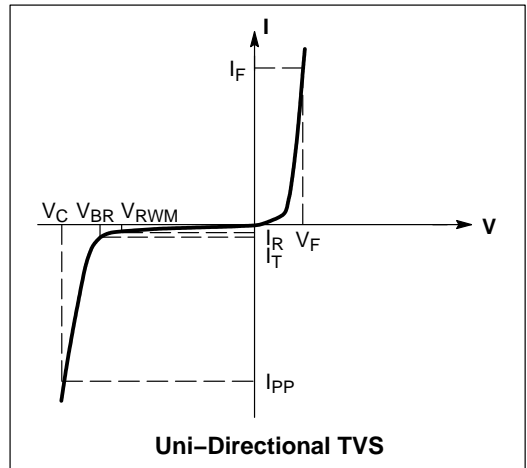

SMF5.0AT1 Series

ELECTRICAL CHARACTERISTICS ($T_L = 30^\circ\text{C}$ unless otherwise noted, $V_F = 1.25$ Volts @ 200 mA)

Device	Marking	V_{RWM} (V)	V_{BR} @ I_T (V) (Note 6)			I_T	I_R @ V_{RWM}	$V_C(\text{Max})$	$I_{PP}(\text{Max})$ (A)
		(Note 5)	Min	Nom	Max	(mA)	(μA)	(V)	(Note 7)
SMF5.0A	KE	5	6.4	6.7	7	10	400	9.2	21.7
SMF6.0A	KG	6	6.67	7.02	7.37	10	400	10.3	19.4
SMF6.5A	KK	6.5	7.22	7.6	7.98	10	250	11.2	17.9
SMF7.0A	KM	7	7.78	8.2	8.6	10	100	12	16.7
SMF7.5A	KP	7.5	8.33	8.77	9.21	1	50	12.9	15.5
SMF8.0A	KR	8	8.89	9.36	9.83	1	25	13.6	14.7
SMF8.5A	KT	8.5	9.44	9.92	10.4	1	10	14.4	13.9
SMF9.0A	KV	9	10	10.55	11.1	1	5	15.4	13.0
SMF10A	KX	10	11.1	11.7	12.3	1	2.5	17	11.8
SMF11A	KZ	11	12.2	12.85	13.5	1	2.5	18.2	11.0
SMF12A	LE	12	13.3	14	14.7	1	2.5	19.9	10.1
SMF13A	LG	13	14.4	15.15	15.9	1	1	21.5	9.3
SMF14A	LK	14	15.6	16.4	17.2	1	1	23.2	8.6
SMF15A	LM	15	16.7	17.6	18.5	1	1	24.4	8.2
SMF16A	LP	16	17.8	18.75	19.7	1	1	26	7.7
SMF17A	LR	17	18.9	19.9	20.9	1	1	27.6	7.2
SMF18A	LT	18	20	21	22.1	1	1	29.2	6.8
SMF20A	LV	20	22.2	23.35	24.5	1	1	32.4	6.2
SMF22A	LX	22	24.4	25.6	26.9	1	1	35.5	5.6
SMF24A	LZ	24	26.7	28.1	29.5	1	1	38.9	5.1
SMF26A	ME	26	28.9	30.4	31.9	1	1	42.1	4.8
SMF28A	MG	28	31.1	32.8	34.4	1	1	45.4	4.4
SMF30A	MK	30	33.3	35.1	36.8	1	1	48.4	4.1
SMF33A	MM	33	36.7	38.7	40.6	1	1	53.3	3.8
SMF36A	MP	36	40	42.1	44.2	1	1	58.1	3.4
SMF40A	MR	40	44.4	46.8	49.1	1	1	64.5	3.1
SMF43A	MT	43	47.8	50.3	52.8	1	1	69.4	2.9
SMF45A	MV	45	50	52.65	55.3	1	1	72.7	2.8
SMF48A	MX	48	53.3	56.1	58.9	1	1	77.4	2.6
SMF51A	MZ	51	56.7	59.7	62.7	1	1	82.4	2.4
SMF54A	NE	54	60	63.15	66.3	1	1	87.1	2.3
SMF58A	NG	58	64.4	67.8	71.2	1	1	93.6	2.1
SMF60A	NK	60	66.7	70.2	73.7	1	1	96.8	1.8
SMF64A	NM	64	71.1	74.85	78.6	1	1	103	1.7
SMF70A	NP	70	77.8	81.9	86	1	1	113	1.5
SMF75A	NR	75	83.3	87.7	92.1	1	1	121	1.4
SMF78A	NT	78	86.7	91.25	95.8	1	1	126	1.4
SMF85A	NV	85	94.4	99.2	104	1	1	137	1.3
SMF90A	NX	90	100	105.5	111	1	1	146	1.2
SMF100A	NZ	100	111	117	123	1	1	162	1.1
SMF110A	PE	110	122	128.5	135	1	1	177	1.0
SMF120A	PG	120	133	140	147	1	1	193	0.9
SMF130A	PK	130	144	151.5	159	1	1	209	0.8
SMF150A	PM	150	167	176	185	1	1	243	0.7
SMF160A	PP	160	178	187.5	197	1	1	259	0.7
SMF170A	PR	170	189	199	209	1	1	275	0.6

5. A transient suppressor is normally selected according to the Working Peak Reverse Voltage (V_{RWM}) which should be equal to or greater than the DC or continuous peak operating voltage level.

6. V_{BR} measured at pulse test current I_T at ambient temperature of 25°C .

7. Surge current waveform per Figure 2 and derate per Figure 3.

SMF5.0AT1 Series

TYPICAL PROTECTION CIRCUIT

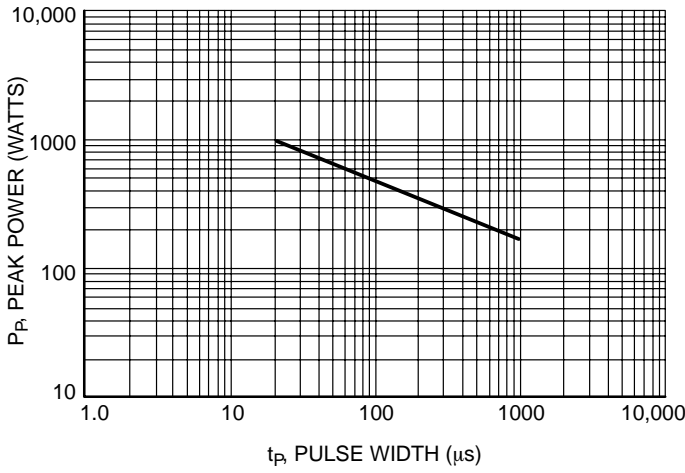
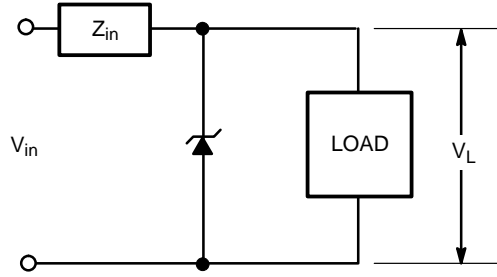

Figure 1. Pulse Rating Curve

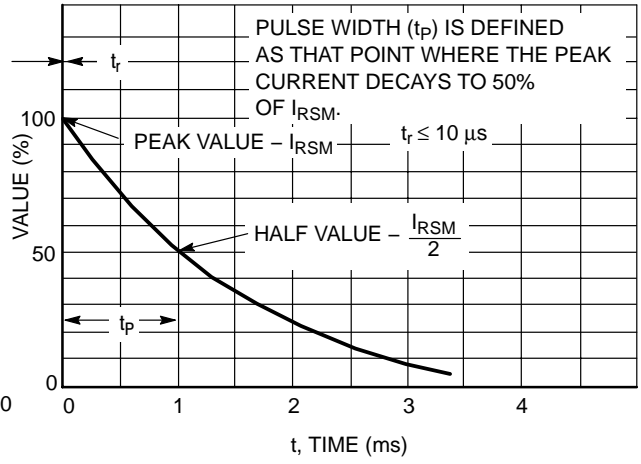

Figure 2. 10 X 1000 μs Pulse Waveform

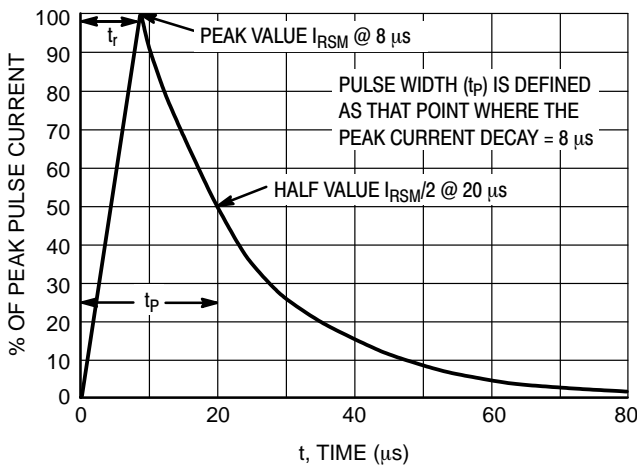

Figure 3. 8 X 20 μs Pulse Waveform

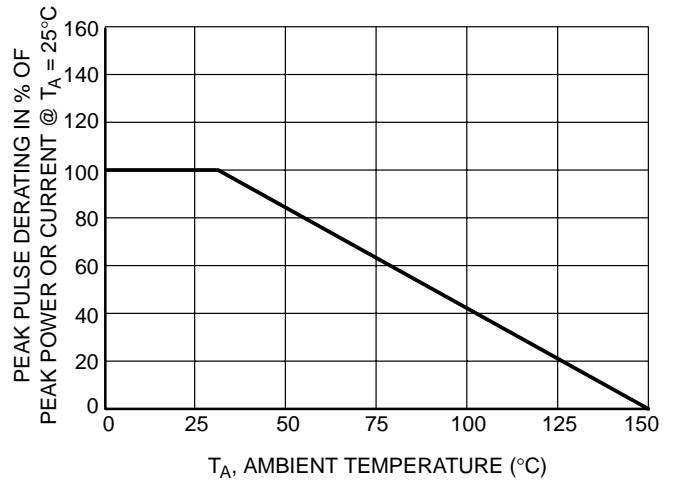

Figure 4. Pulse Derating Curve

SMF5.0AT1 Series

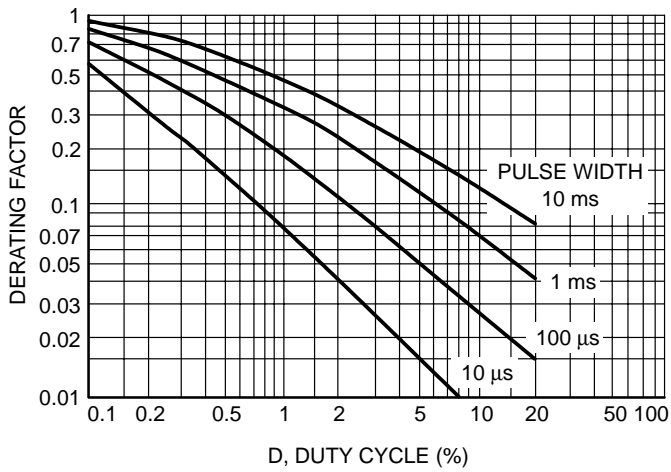

Figure 5. Typical Derating Factor for Duty Cycle

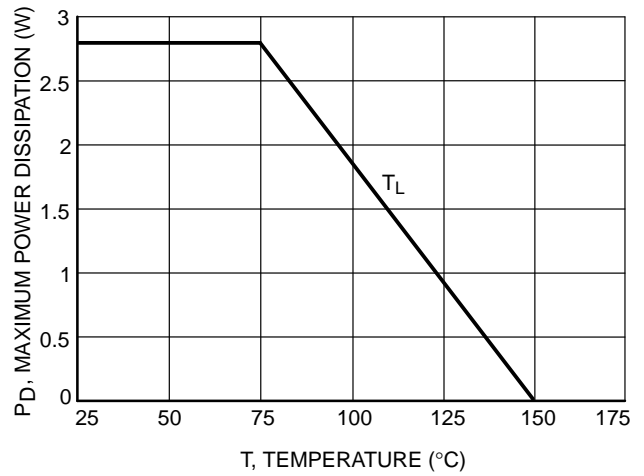

Figure 6. Steady State Power Derating

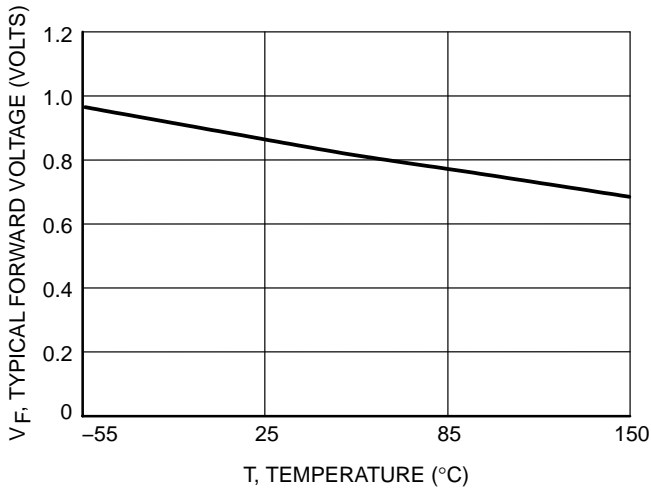

Figure 7. Forward Voltage

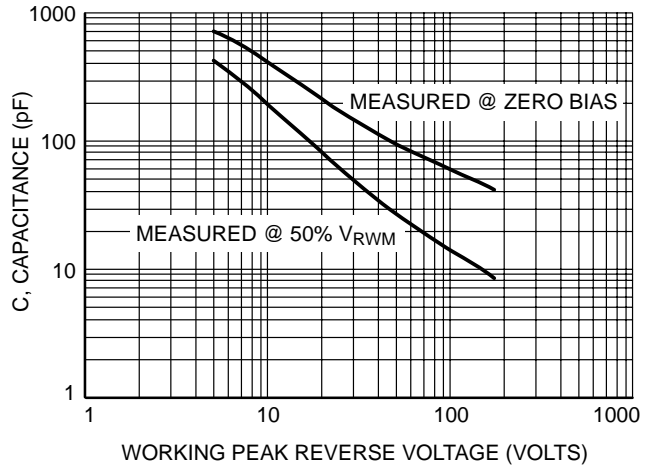

Figure 8. Capacitance versus Working Peak Reverse Voltage

INFORMATION FOR USING THE SOD-123 FLAT LEAD SURFACE MOUNT PACKAGE

MINIMUM RECOMMENDED FOOTPRINT FOR SURFACE MOUNTED APPLICATIONS

Surface mount board layout is a critical portion of the total design. The footprint for the semiconductor packages must be the correct size to insure proper solder connection

interface between the board and the package. With the correct pad geometry, the packages will self align when subjected to a solder reflow process.

RECOMMENDED FOOTPRINT FOR SOD-123FL

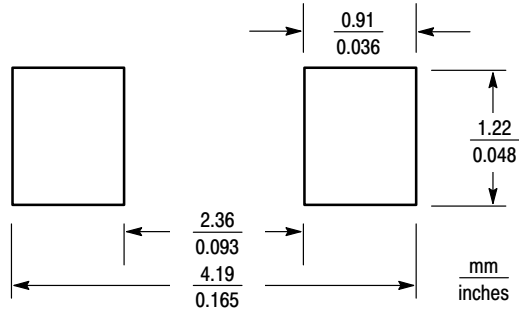

POWERMITE POWER DISSIPATION

The power dissipation of the SOD-123 Flat Lead is a function of the mounting pad size. This can vary from the minimum pad size for soldering to a pad size given for maximum power dissipation. Power dissipation for a surface mount device is determined by $T_{J(max)}$, the maximum rated junction temperature of the die, $R_{\theta JA}$, the thermal resistance from the device junction to ambient, and the operating temperature, T_A . Using the values provided on the data sheet for the SOD-123 Flat Lead package, P_D can be calculated as follows:

$$P_D = \frac{T_{J(max)} - T_A}{R_{\theta JA}}$$

The values for the equation are found in the maximum ratings table on the data sheet. Substituting these values into the equation for an ambient temperature T_A of 25°C,

one can calculate the power dissipation of the device which in this case is 385 milliwatts.

$$P_D = \frac{150^\circ\text{C} - 25^\circ\text{C}}{325^\circ\text{C/W}} = 385 \text{ milliwatts}$$

The 325°C/W for the SOD-123 Flat Lead package assumes the use of the recommended footprint on a glass epoxy printed circuit board to achieve a power dissipation of 385 milliwatts. There are other alternatives to achieving higher power dissipation from the SOD-123 Flat Lead package. Another alternative would be to use a ceramic substrate or an aluminum core board such as Thermal Clad®. Using a board material such as Thermal Clad, an aluminum core board, the power dissipation can be doubled using the same footprint.

SOLDERING PRECAUTIONS

The melting temperature of solder is higher than the rated temperature of the device. When the entire device is heated to a high temperature, failure to complete soldering within a short time could result in device failure. Therefore, the following items should always be observed in order to minimize the thermal stress to which the devices are subjected.

- Always preheat the device.
- The delta temperature between the preheat and soldering should be 100°C or less.*
- When preheating and soldering, the temperature of the leads and the case must not exceed the maximum temperature ratings as shown on the data sheet. When using infrared heating with the reflow soldering method, the difference shall be a maximum of 10°C.

- The soldering temperature and time shall not exceed 260°C for more than 10 seconds.
- When shifting from preheating to soldering, the maximum temperature gradient shall be 5°C or less.
- After soldering has been completed, the device should be allowed to cool naturally for at least three minutes. Gradual cooling should be used as the use of forced cooling will increase the temperature gradient and result in latent failure due to mechanical stress.
- Mechanical stress or shock should not be applied during cooling.

* Soldering a device without preheating can cause excessive thermal shock and stress which can result in damage to the device.

SMF5.0AT1 Series

OUTLINE DIMENSIONS

Transient Voltage Suppressor – Surface Mounted

200 Watt Peak Power

SOD-123FL
CASE 498-01
ISSUE O

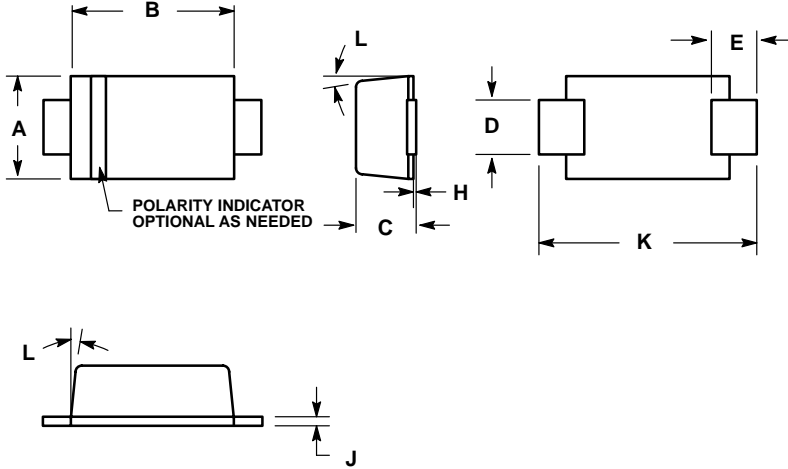

- NOTES:
1. DIMENSIONING AND TOLERANCING PER ANSI Y14.5M, 1982.
 2. CONTROLLING DIMENSION: MILLIMETER.
 3. DIMENSIONS A AND B DO NOT INCLUDE MOLD FLASH.
 4. DIMENSIONS D AND J ARE TO BE MEASURED ON FLAT SECTION OF THE LEAD: BETWEEN 0.10 AND 0.25 MM FROM THE LEAD TIP.

DIM	MILLIMETERS		INCHES	
	MIN	MAX	MIN	MAX
A	1.50	1.80	0.059	0.071
B	2.50	2.90	0.098	0.114
C	0.90	1.00	0.035	0.039
D	0.70	1.10	0.028	0.043
E	0.55	0.95	0.022	0.037
H	0.00	0.10	0.000	0.004
J	0.10	0.20	0.004	0.008
K	3.40	3.80	0.134	0.150
L	0°	8°	0°	8°

SMF5.0AT1 Series

Thermal Clad is a registered trademark of the Bergquist Company.

ON Semiconductor and  are registered trademarks of Semiconductor Components Industries, LLC (SCILLC). SCILLC reserves the right to make changes without further notice to any products herein. SCILLC makes no warranty, representation or guarantee regarding the suitability of its products for any particular purpose, nor does SCILLC assume any liability arising out of the application or use of any product or circuit, and specifically disclaims any and all liability, including without limitation special, consequential or incidental damages. "Typical" parameters which may be provided in SCILLC data sheets and/or specifications can and do vary in different applications and actual performance may vary over time. All operating parameters, including "Typicals" must be validated for each customer application by customer's technical experts. SCILLC does not convey any license under its patent rights nor the rights of others. SCILLC products are not designed, intended, or authorized for use as components in systems intended for surgical implant into the body, or other applications intended to support or sustain life, or for any other application in which the failure of the SCILLC product could create a situation where personal injury or death may occur. Should Buyer purchase or use SCILLC products for any such unintended or unauthorized application, Buyer shall indemnify and hold SCILLC and its officers, employees, subsidiaries, affiliates, and distributors harmless against all claims, costs, damages, and expenses, and reasonable attorney fees arising out of, directly or indirectly, any claim of personal injury or death associated with such unintended or unauthorized use, even if such claim alleges that SCILLC was negligent regarding the design or manufacture of the part. SCILLC is an Equal Opportunity/Affirmative Action Employer.

PUBLICATION ORDERING INFORMATION

Literature Fulfillment:

Literature Distribution Center for ON Semiconductor
P.O. Box 5163, Denver, Colorado 80217 USA
Phone: 303-675-2175 or 800-344-3860 Toll Free USA/Canada
Fax: 303-675-2176 or 800-344-3867 Toll Free USA/Canada
Email: ONlit@hibbertco.com

N. American Technical Support: 800-282-9855 Toll Free USA/Canada

JAPAN: ON Semiconductor, Japan Customer Focus Center
2-9-1 Kamimeguro, Meguro-ku, Tokyo, Japan 153-0051
Phone: 81-3-5773-3850

ON Semiconductor Website: <http://onsemi.com>

For additional information, please contact your local Sales Representative.