



MJE13005

NPN SILICON TRANSISTOR

NPN SILICON POWER TRANSISTORS

DESCRIPTION

These devices are designed for high-voltage, high-speed power switching inductive circuits where fall time is critical. They are particularly suited for 115 and 220 V SWITCHMODE.

FEATURES

- * $V_{CEO(SUS)} = 400\text{ V}$
- * Reverse bias SOA with inductive loads @ $T_C = 100^\circ\text{C}$
- * Inductive switching matrix 2 to 4 Amp, 25 and 100°C
 $t_c @ 3\text{A}, 100^\circ\text{C}$ is 180 ns (Typ)
- * 700V blocking capability
- * SOA and switching applications information

APPLICATIONS

- * Switching regulator's, inverters
- * Motor controls
- * Solenoid/Relay drivers
- * Deflection circuits

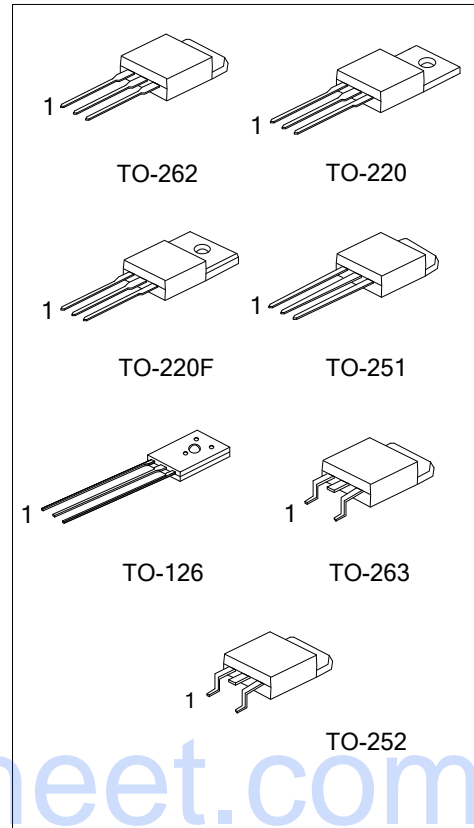

ORDERING INFORMATION

Ordering Number		Package	Pin Assignment			Packing
Lead Free	Halogen Free		1	2	3	
MJE13005L-x-T60-K	MJE13005G-x-T60-K	TO-126	B	C	E	Bulk
MJE13005L-x-TA3-T	MJE13005G-x-TA3-T	TO-220	B	C	E	Tube
MJE13005L-x-TF3-T	MJE13005G-x-TF3-T	TO-220F	B	C	E	Tube
MJE13005L-x-TM3-T	MJE13005G-x-TM3-T	TO-251	B	C	E	Tube
MJE13005L-x-TN3-T	MJE13005G-x-TN3-T	TO-252	B	C	E	Tube
MJE13005L-x-TN3-T	MJE13005G-x-TN3-T	TO-252	B	C	E	Tape Reel
MJE13005L-x-TQ3-R	MJE13005G-x-TQ3-R	TO-263	B	C	E	Tape Reel
MJE13005L-x-TQ3-T	MJE13005G-x-TQ3-T	TO-263	B	C	E	Tube
MJE13005L-x-T2Q-T	MJE13005G-x-T2Q-T	TO-262	B	C	E	Tube

<p>MJE13005L-x-T60-K</p>	<p>(1)T: Tube, K: Bulk, R: Tape Reel (2) T60: TO-126, TA3: TO-220, TF3: TO-220F, TM3: TO-251, TQ3: TO-263, T2Q: TO-262 TN3: TO-252 (3) x: refer to Classification of h_{FE1} (4) L: Lead Free, G: Halogen Free</p>
--------------------------	---

■ ABSOLUTE MAXIMUM RATINGS

PARAMETER		SYMBOL	RATINGS	UNIT
Collector-Emitter Voltage		$V_{CEO(SUS)}$	400	V
Collector-Emitter Voltage ($V_{BE}=0$)		V_{CES}	700	V
Collector-Base Voltage		V_{CBO}	700	V
Emitter Base Voltage		V_{EBO}	9	V
Collector Current	Continuous	I_C	4	A
	Peak (1)	I_{CM}	8	A
Base Current	Continuous	I_B	2	A
	Peak (1)	I_{BM}	4	A
Emitter Current	Continuous	I_E	6	A
	Peak (1)	I_{EM}	12	A
Power Dissipation at $T_A=25^\circ\text{C}$	TO-126/TO-220F	P_D	40	W
	TO-251/TO-252		50	
	TO-220/TO-263		75	
	TO-262			
Derate above 25°C	TO-126/TO-220F		320	mW/ $^\circ\text{C}$
	TO-251/TO-252		400	
	TO-220/TO-263		600	
	TO-262			
Operating and Storage Junction Temperature		T_J, T_{STG}	-65 ~ +150	$^\circ\text{C}$

Note: Absolute maximum ratings are those values beyond which the device could be permanently damaged.

Absolute maximum ratings are stress ratings only and functional device operation is not implied.

■ THERMAL DATA

PARAMETER		SYMBOL	RATINGS	UNIT
Junction to Ambient	TO-126	θ_{JA}	89	$^\circ\text{C/W}$
	TO-251/TO-252		110	
	TO-220/TO-263		62.5	
	TO-262/TO-220F			
Junction to Case	TO-126/TO-220F	θ_{JC}	3.125	$^\circ\text{C/W}$
	TO-251/TO-252		2.5	
	TO-220/TO-263		1.67	
	TO-262			

■ ELECTRICAL CHARACTERISTICS (T_C=25°C, unless otherwise specified)

PARAMETER	SYMBOL	TEST CONDITIONS	MIN	TYP	MAX	UNIT
OFF CHARACTERISTICS (Note 1)						
Collector-Emitter Sustaining Voltage	V _{CEO(SUS)}	I _C =10mA, I _B =0	400			V
Collector Cutoff Current	I _{CBO}	V _{CBO} =Rated Value, V _{BE(OFF)} =1.5V			1	mA
		V _{CBO} =Rated Value, V _{BE(OFF)} =1.5V, T _C =100°C			5	
Emitter Cutoff Current	I _{EBO}	V _{EB} =9V, I _C =0			1	mA
SECOND BREAKDOWN						
Second Breakdown Collector Current with base forward biased	I _{S/B}				See Fig. 11	
Clamped Inductive SOA with Base Reverse Biased	RBSOA				See Fig. 12	
ON CHARACTERISTICS (Note 1)						
DC Current Gain	h _{FE1}	I _C =0.5A, V _{CE} =5V	15		50	
	h _{FE2}	I _C =1A, V _{CE} =5V	10		60	
	h _{FE3}	I _C =2A, V _{CE} =5V	8		40	
Collector-Emitter Saturation Voltage	V _{CE(SAT)}	I _C =1A, I _B =0.2A			0.5	V
		I _C =2A, I _B =0.5A			0.6	V
		I _C =4A, I _B =1A			1	V
		I _C =2A, I _B =0.5A, T _a =100°C			1	V
Base-Emitter Saturation Voltage	V _{BE(SAT)}	I _C =1A, I _B =0.2A			1.2	V
		I _C =2A, I _B =0.5A			1.6	V
		I _C =2A, I _B =0.5A, T _C =100°C			1.5	V
DYNAMIC CHARACTERISTICS						
Current-Gain-Bandwidth Product	f _T	I _C =500mA, V _{CE} =10V, f=1MHz	4			MHz
Output Capacitance	C _{OB}	V _{CB} =10V, I _E =0, f=0.1MHz		65		pF
SWITCHING CHARACTERISTICS						
Resistive Load (Table 1)						
Delay Time	t _D	V _{CC} =125V, I _C =2A, I _{B1} =I _{B2} =0.4A, t _P =25μs, Duty Cycle≤1%		0.025	0.1	μs
Rise Time	t _R			0.3	0.7	μs
Storage Time	t _S			1.7	4	μs
Fall Time	t _F			0.4	0.9	μs

Note: 1. Pulse Test: Pulse Width=5ms, Duty Cycle≤10%

2. Pulse Test: P_W=300μs, Duty Cycle≤2%

■ CLASSIFICATION OF h_{FE1}

RANK	A	B	C	D	E
RANGE	15 ~ 20	20 ~ 25	25 ~ 30	30 ~ 40	40 ~ 50

APPLICATION INFORMATION

Table 1. Test Conditions for Dynamic Performance

Reverse Bias Safe Operating Area and Inductive Switching		Resistive Switching
Test Circuits	<p>Note: PW and V_{CC} Adjusted for Desired I_C R_B Adjusted for Desired I_{B1}</p>	<p>*SELECTED FOR ≥ 1kV</p>
Circuit Values	<p>Coil Data : V_{CC}=20V FERROXCUBE core #6656 Full Bobbin (~ 16 Turns) #16</p> <p>GAP for 200µH/20 A L_{COIL}=200µH V_{CLAMP}=300V</p>	<p>V_{CC}=125V R_C=62Ω D1=1n5820 or Equiv. R_B=22Ω</p>
Test Waveforms	<p>OUTPUT WAVEFORMS</p> <p>t₁ Adjusted to Obtain I_C</p> $t_1 = \frac{L_{COIL}(I_{CPK})}{V_{CC}}$ $t_2 = \frac{L_{COIL}(I_{CPK})}{V_{CLAMP}}$ <p>Test Equipment Scope-Tektronics 475 or Equivalent</p>	<p>t_r, t_f<10ns Duty Cycle=1.0% R_B and R_C adjusted for desired I_B and I_C</p>

RESISTIVE SWITCHING PERFORMANCE

Fig. 1 Turn-On Time

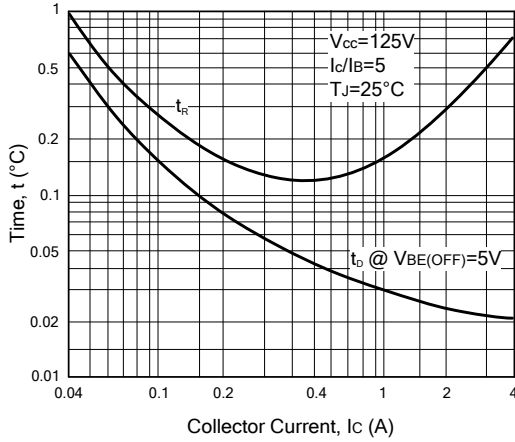

Fig. 2 Turn-Off Time

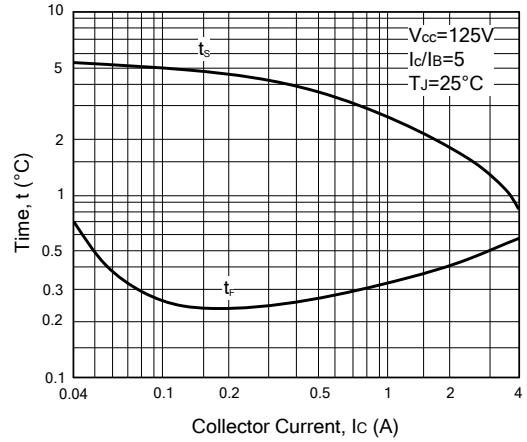

Fig. 3 Typical Thermal Response [$Z_{\theta JC}(t)$]

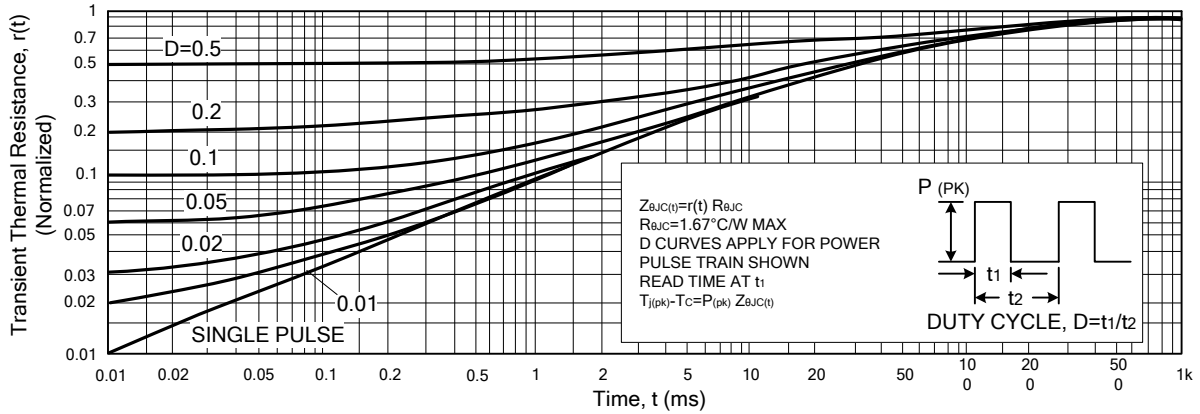

Fig. 4 Forward Bias Safe Operating Area

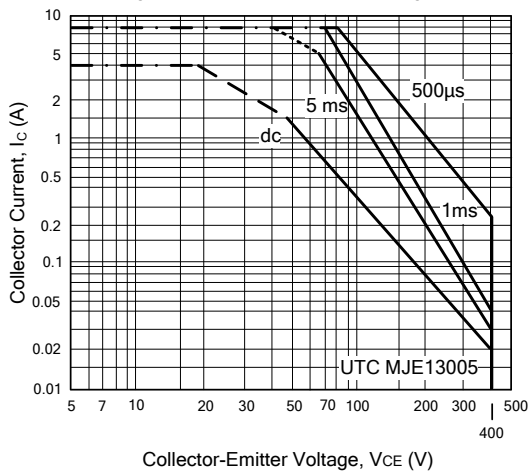
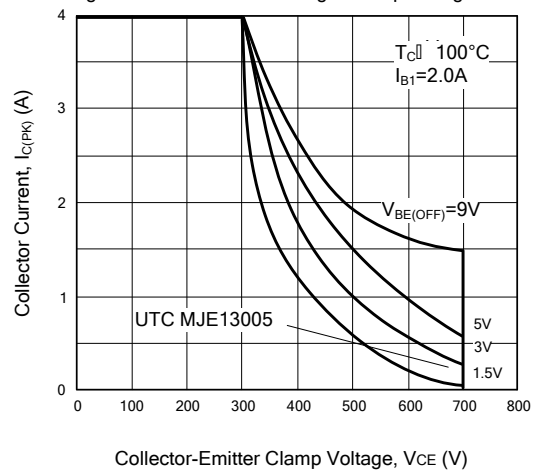
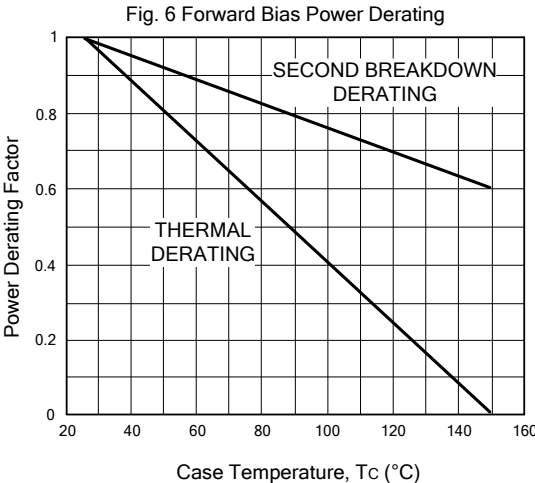

Fig. 5 Reverse Bias Switching Safe Operating Area



■ RESISTIVE SWITCHING PERFORMANCE(Cont.)



■ SAFE OPERATING AREA INFORMATION**FORWARD BIAS**

There are two limitations on the power handling ability of a transistor: average junction temperature and second breakdown. Safe operating area curves indicate I_C - V_{CE} limits of the transistor that must be observed for reliable operation; e., the transistor must not be subjected to greater dissipation than the curves indicate.

The data of Fig. 4 is based on $T_C = 25^\circ\text{C}$; $T_{J(PK)}$ is variable depending on power level. Second breakdown pulse limits are valid for duty cycles to 10% but must be derated when $T_C \geq 25^\circ\text{C}$. Second breakdown limitations do not derate the same as thermal limitations. Allowable current at the voltages shown on Fig. 4 may be found at any case temperature by using the appropriate curve on Fig. 6.

$T_{J(PK)}$ may be calculated from the data in Fig. 10. At high case temperatures, thermal limitations will reduce the power that can be handled to values less than the limitations imposed by second breakdown.

REVERSE BIAS

For inductive loads, high voltage and high current must be sustained simultaneously during turn-off, in most cases, with the base to emitter junction reverse biased. Under these conditions the collector voltage must be held to a safe level at or below a specific value of collector current. This can be accomplished by several means such as active clamping, RC snubbing, load line shaping, etc. The safe level for these devices is specified as Reverse Bias Safe Operating Area and represents the voltage-current conditions during reverse biased turn-off. This rating is verified under clamped conditions so that the device is never subjected to an avalanche mode. Figure 5 gives the complete RBSOA characteristics.

TYPICAL CHARACTERISTICS

Figure 7. DC Current Gain

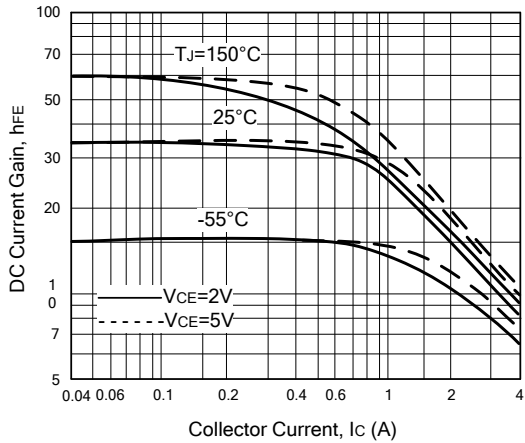

Figure 8. Collector Saturation Region

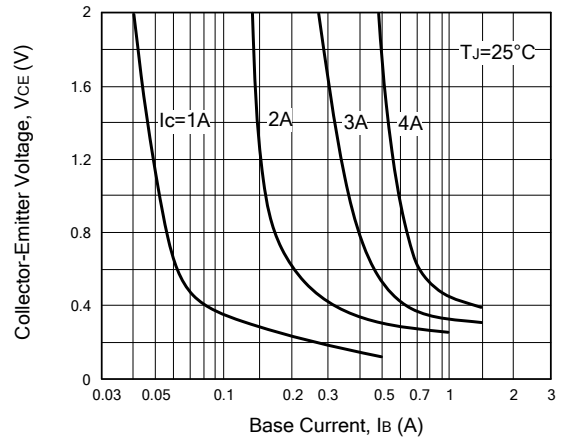

Figure 9. Base-Emitter Voltage

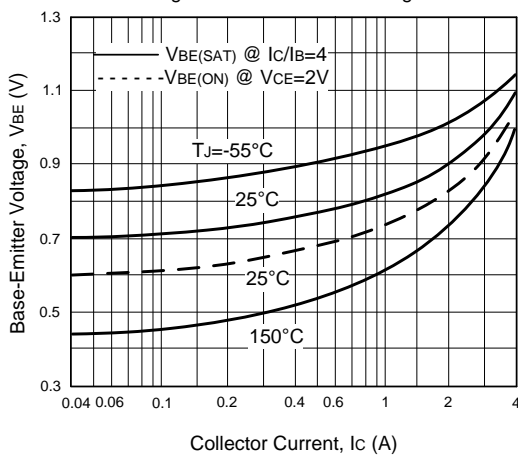

Figure 10. Collector-Emitter Saturation Voltage

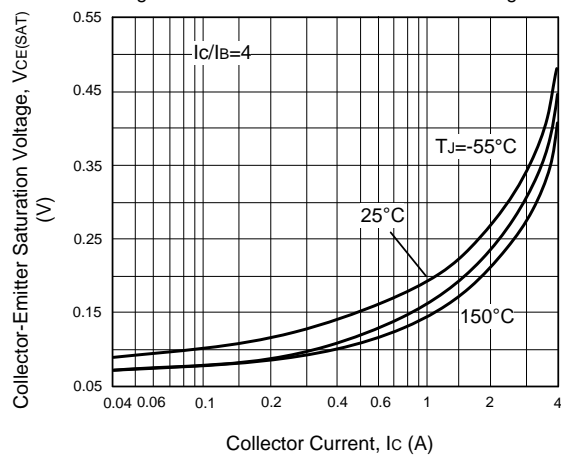

Figure 11. Collector Cutoff Region

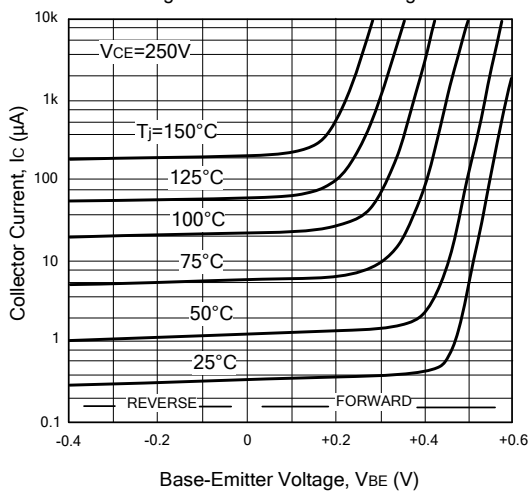
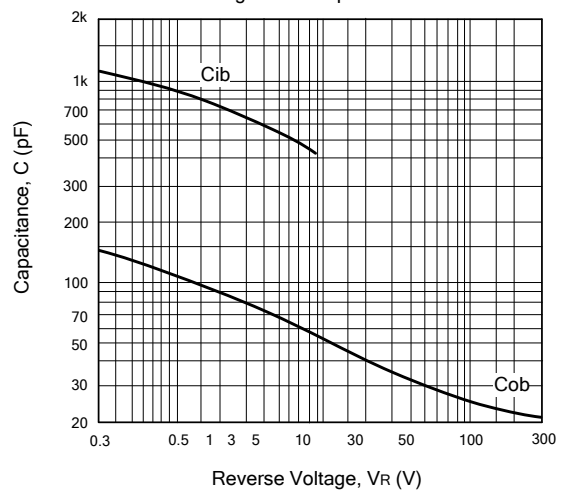

Figure 12. Capacitance



UTC assumes no responsibility for equipment failures that result from using products at values that exceed, even momentarily, rated values (such as maximum ratings, operating condition ranges, or other parameters) listed in products specifications of any and all UTC products described or contained herein. UTC products are not designed for use in life support appliances, devices or systems where malfunction of these products can be reasonably expected to result in personal injury. Reproduction in whole or in part is prohibited without the prior written consent of the copyright owner. The information presented in this document does not form part of any quotation or contract, is believed to be accurate and reliable and may be changed without notice.