



DC COMPONENTS CO., LTD.

RECTIFIER SPECIALISTS

**SA5.0
THRU
SA170CA**

TECHNICAL SPECIFICATIONS OF TRANSIENT VOLTAGE SUPPRESSOR

VOLTAGE RANGE - 5.0 to 170 Volts

PEAK PULSE POWER - 500 Watts

FEATURES

- * Glass passivated junction
- * 500 Watts Peak Pulse Power capability on 10/1000 μ s waveform
- * Excellent clamping capability
- * Low zener impedance
- * Fast response time

MECHANICAL DATA

- * Case: Molded plastic
- * Epoxy: UL 94V-0 rate flame retardant
- * Lead: MIL-STD-202E, Method 208 guaranteed
- * Polarity: Color band denotes positive end (cathode) except bidirectional types
- * Mounting position: Any
- * Weight: 0.4 gram

MAXIMUM RATINGS AND ELECTRICAL CHARACTERISTICS

Ratings at 25 °C ambient temperature unless otherwise specified.
Single phase, half wave, 60 Hz, resistive or inductive load,
For capacitive load, derate current by 20%.

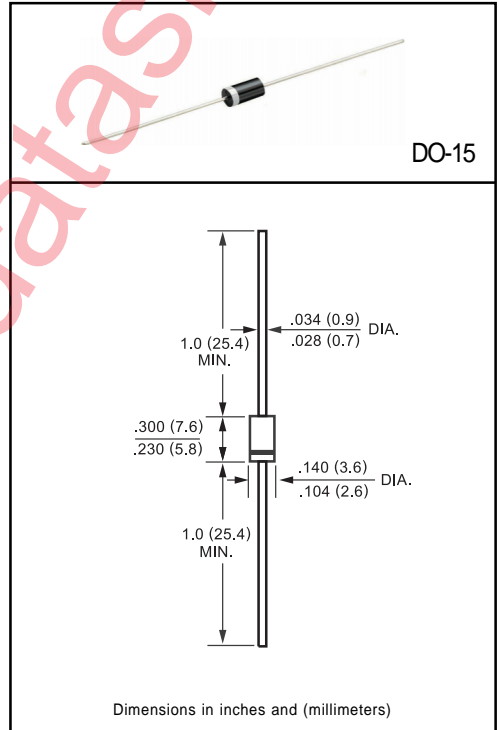

DEVICES FOR BIPOLAR APPLICATIONS

For Bidirectional use C or CA suffix (e.g. SA5.0C, SA170CA)

Electrical characteristics apply in both directions

	SYMBOL	VALUE	UNITS
Peak Pulse Power Dissipation on 10/1000 μ s waveform (Note 1, FIG. 1)	PPM	Minimum 500	Watts
Steady State Power Dissipation at $T_L = 75^\circ\text{C}$ Lead Lengths .375" (9.5 mm) (Note 2)	PM (AV)	1.0	Watts
Peak Forward Surge Current, 8.3ms single half sine-wave superimposed on rated load(JEDEC Method) (Note 3)	IFSM	70	Amps
Maximum Instantaneous Forward Voltage at 35A for Unidirectional Only	VF	3.5	Volts
Operating and Storage Temperature Range	TJ, TSTG	-65 to + 175	$^\circ\text{C}$

- NOTES : 1. Non-repetitive current pulse, per Fig.3 and derated above $T_A = 25^\circ\text{C}$ per Fig.2.
2. Mounted on Copper Leaf area of 1.6 X 1.6" (40X40 mm) per Fig. 5
3. 8.3ms single half sine-wave or equivalent square wave, duty cycle = 4 pulses per minute maximum.

RATING AND CHARACTERISTIC CURVES (SA5.0 THRU SA170CA)

FIG. 1 - PEAK PULSE POWER RATING CURVE

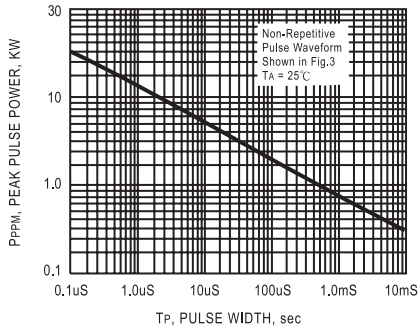

FIG. 2 - PULSE DERATING CURVE

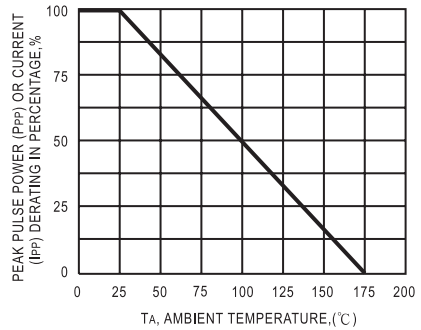

FIG. 3 - PULSE WAVEFORM

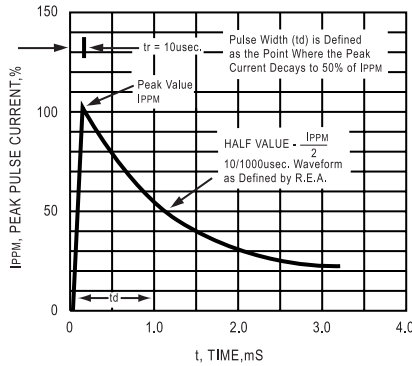

FIG. 4 - TYPICAL JUNCTION CAPACITANCE

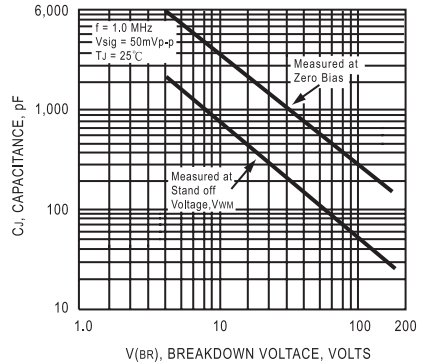

FIG. 5 - STEADY STATE POWER DERATING CURVE

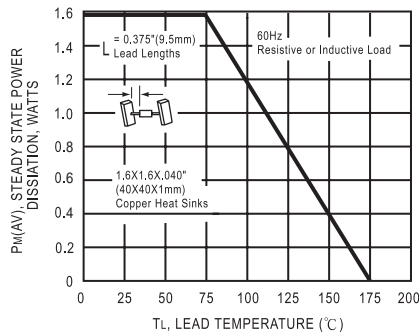

FIG. 6 - MAXIMUM NON-REPETITIVE FORWARD SURGE CURRENT UNIDIRECTIONAL

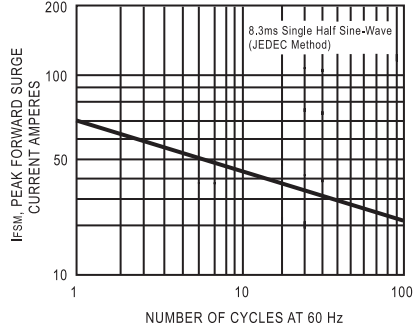
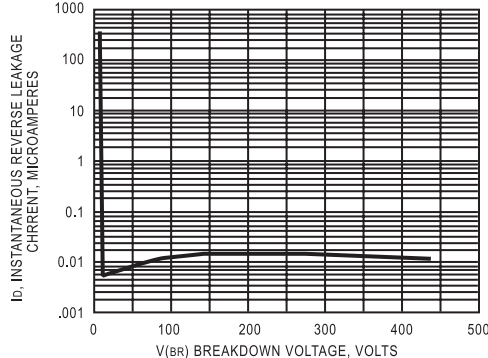

FIG. 7 - TYPICAL REVERSE LEAKAGE CHARACTERISTICS



DC COMPONENTS CO., LTD.

SA (500W) SERIES TRANSIENT VOLTAGE SUPPRESSORS

TYPE	Breakdown Voltage			Reverse Stand off Voltage V _{WM} (Volts)	Maximum Reverse Leakage at V _{WM} I _D (μ A)	Maximum Peak Pulse Current IPPM (Amps)	Maximum Clamping Voltage at IPPM V _C (Volts)
	V _{BR} (Volts)		@I _T (mA)				
	MIN.	MAX.					
SA5.0	6.40	7.30	1.0	5.0	600	52.0	9.6
SA5.0A	6.40	7.00	1.0	5.0	600	54.3	9.2
SA6.0	6.67	8.15	1.0	6.0	600	43.9	11.4
SA6.0A	6.67	7.37	1.0	6.0	600	48.5	10.3
SA6.5	7.22	8.82	1.0	6.5	400	40.7	12.3
SA6.5A	7.22	7.98	1.0	6.5	400	44.7	11.2
SA7.0	7.78	9.51	1.0	7.0	150	37.8	13.3
SA7.0A	7.78	8.60	1.0	7.0	150	41.7	12.0
SA7.5	8.33	10.2	1.0	7.5	50	35.0	14.3
SA7.5A	8.33	9.21	1.0	7.5	50	38.8	12.9
SA8.0	8.89	10.9	1.0	8.0	25	33.3	15.0
SA8.0A	8.89	9.83	1.0	8.0	25	36.7	13.6
SA8.5	9.44	11.5	1.0	8.5	10	31.4	15.9
SA8.5A	9.44	10.4	1.0	8.5	10	34.7	14.4
SA9.0	10.0	12.2	1.0	9.0	5.0	29.5	16.9
SA9.0A	10.0	11.1	1.0	9.0	5.0	32.5	15.4
SA10	11.1	13.6	1.0	10.0	3.0	26.6	18.8
SA10A	11.1	12.3	1.0	10.0	3.0	29.4	17.0
SA11	12.2	14.9	1.0	11.0	3.0	24.9	20.1
SA11A	12.2	13.5	1.0	11.0	3.0	27.4	18.2
SA12	13.3	16.3	1.0	12.0	3.0	22.7	22.0
SA12A	13.3	14.7	1.0	12.0	3.0	25.1	19.9
SA13	14.4	17.6	1.0	13.0	3.0	21.0	23.8
SA13A	14.4	15.9	1.0	13.0	3.0	23.2	21.5
SA14	15.6	19.1	1.0	14.0	3.0	19.4	25.8
SA14A	15.6	17.2	11.0	14.0	3.0	21.5	23.2
SA15	16.7	20.4	1.0	15.0	3.0	18.8	26.9
SA15A	16.7	18.5	1.0	15.0	3.0	20.6	24.4
SA16	17.8	21.8	1.0	16.0	3.0	17.6	28.8
SA16A	17.8	19.7	1.0	16.0	3.0	19.2	26.0
SA17	18.9	23.1	1.0	17.0	3.0	16.4	30.5
SA17A	18.9	20.9	1.0	17.0	3.0	18.1	27.6
SA18	20.0	24.4	1.0	18.0	3.0	15.5	32.2
SA18A	20.0	22.1	1.0	18.0	3.0	17.2	29.2
SA20	22.2	27.1	1.0	20.0	3.0	13.9	35.8
SA20A	22.2	24.5	1.0	20.0	3.0	15.4	32.4
SA22	24.4	29.8	1.0	22.0	3.0	12.7	39.4
SA22A	24.4	26.9	1.0	22.0	3.0	14.1	35.5
SA24	26.7	32.6	1.0	24.0	3.0	11.6	43.0
SA24A	26.7	29.5	1.0	24.0	3.0	12.8	38.9
SA26	28.9	35.3	1.0	26.0	3.0	10.7	46.6
SA26A	28.9	31.9	1.0	26.0	3.0	11.9	42.1
SA28	31.1	38.0	1.0	28.0	3.0	9.9	50.1
SA28A	31.1	34.4	1.0	28.0	3.0	11.0	45.4
SA30	33.3	40.7	1.0	30.0	3.0	9.3	53.5
SA30A	33.3	36.8	1.0	30.0	3.0	10.3	48.4
SA33	36.7	44.9	1.0	33.0	3.0	8.6	59.0
SA33A	36.7	4.06	1.0	33.0	3.0	9.4	53.5



DC COMPONENTS CO., LTD.

SA (500W) SERIES TRANSIENT VOLTAGE SUPPRESSORS

TYPE	Breakdown Voltage			Reverse Stand off Voltage VWM (Volts)	Maximum Reverse Leakage at VWM Id(uA)	Maximum Peak Pulse Current IPPM (Amps)	Maximum Clamping Voltage at IPPM Vc (Volts)
	VBR (Volts)		@IT (mA)				
	MIN.	MAX.					
SA36	40.0	48.9	1.0	36.0	3.0	7.8	64.3
SA36A	40.0	44.2	1.0	36.0	3.0	8.6	58.1
SA40	44.4	54.3	1.0	40.0	3.0	7.0	71.4
SA40A	44.4	49.1	1.0	40.0	3.0	7.8	64.5
SA43	47.8	58.4	1.0	43.0	3.0	6.5	76.7
SA43A	47.8	52.8	1.0	43.0	3.0	7.2	69.4
SA45	50.0	61.1	1.0	45.0	3.0	6.2	80.3
SA45A	50.0	55.3	1.0	45.0	3.0	6.9	72.7
SA48	53.3	65.2	1.0	48.0	3.0	5.8	85.5
SA48A	53.3	58.9	1.0	48.0	3.0	6.5	77.4
SA51	56.7	69.3	1.0	51.0	3.0	5.5	91.1
SA51A	56.7	62.7	1.0	51.0	3.0	6.1	82.4
SA54	60.0	73.3	1.0	54.0	3.0	5.2	96.3
SA54A	60.0	66.3	1.0	54.0	3.0	5.7	87.1
SA58	64.4	78.7	1.0	58.0	3.0	4.9	103
SA58A	64.4	71.2	1.0	58.0	3.0	5.3	93.6
SA60	66.7	81.5	1.0	60.0	3.0	4.7	107
SA60A	66.7	73.7	1.0	60.6	3.0	5.2	96.8
SA64	71.1	86.9	1.0	64.0	3.0	4.4	114
SA64A	71.1	78.6	1.0	64.0	3.0	4.9	103
SA70	77.8	95.1	1.0	70.0	3.0	4.0	125
SA70A	77.8	86.0	1.0	70.0	3.0	4.4	113
SA75	83.3	102	1.0	75.0	3.0	3.7	134
SA75A	83.3	92.1	1.0	75.0	3.0	4.1	121
SA78	86.7	106	1.0	78.0	3.0	3.6	139
SA78A	86.7	95.8	1.0	78.0	3.0	4.0	126
SA85	94.4	115	1.0	85.0	3.0	3.3	151
SA85A	94.4	104	1.0	85.0	3.0	3.6	137
SA90	100	122	1.0	90.0	3.0	3.1	160
SA90A	100	111	1.0	90.0	3.0	3.4	146
SA100	111	136	1.0	100	3.0	2.8	179
SA100A	111	123	1.0	100	3.0	3.1	162
SA110	122	149	1.0	110	3.0	2.6	196
SA110A	122	135	1.0	110	3.0	2.8	177
SA120	133	163	1.0	120	3.0	2.3	214
SA120A	133	147	1.0	120	3.0	2.0	193
SA130	144	176	1.0	130	3.0	2.2	230
SA130A	144	159	1.0	130	3.0	2.4	209
SA150	167	204	1.0	150	3.0	1.9	268
SA150A	167	185	1.0	150	3.0	2.1	243
SA160	178	218	1.0	160	3.0	1.7	257
SA160A	178	197	1.0	160	3.0	1.9	259
SA170	189	231	1.0	170	3.0	1.6	304
SA170A	189	209	1.0	170	3.0	1.8	275

- NOTES : 1.VBR measured after IT applied for 300 μ s. IT = Square Wave Pulse or equivalent.
 2.For bidirectional use C or CA suffixs for all types (ex. SA5.0C, SA170CA). electrical characteristics apply in both directions.
 3.For bidirectional types having VWM of 10 volts and less, the Id limit is doubled.



DC COMPONENTS CO., LTD.