

SIEMENS



Searchdatastreet.com

Miniature Circuit Breakers

SENTRON

Configu-
ration
Manual

Edition
10/2015

Miniature Circuit Breakers

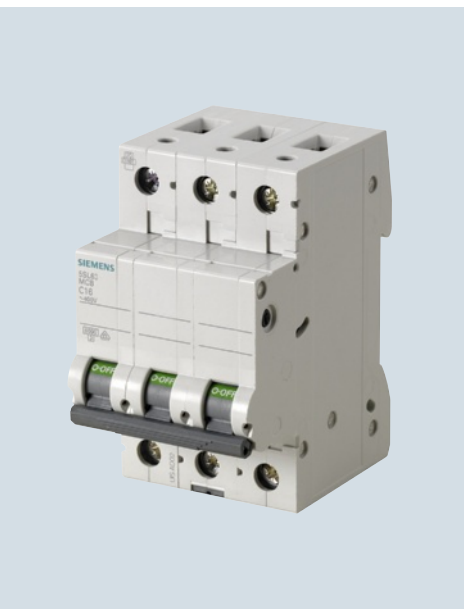

2	Introduction
4	5SL miniature circuit breakers
6	5SY and 5SP miniature circuit breakers
9	5SJ6...-KS miniature circuit breakers, with plug-in terminals
10	5SY miniature circuit breakers, 1+N in 1 MW
12	Additional components
	Busbars
17	5ST standard busbars
21	5ST3 busbars acc. to UL 508
23	5ST2 distribution blocks
26	SIKclip wiring system
28	Configuration and dimensioning
29	Characteristic curves
43	Selectivity
96	Back-up protection
107	Direct current, universal current
109	5SJ4...-HG miniature circuit breakers acc. to UL 489 and IEC, and accessories
112	Characteristic curves
115	Dimensional drawings
119	SHU 5SP3 main miniature circuit breakers
121	Configuration
125	Characteristic curves
127	Dimensional drawings
129	Circuit breaker terminals

For further technical product information:









Siemens Industry Online Support:
www.siemens.com/lowvoltage/product-support



→ Entry type:
 Application example
 Certificate
 Characteristic
 Download
 FAQ
 Manual
 Product note
 Software archive
 Technical data

Miniature Circuit Breakers

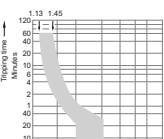
Introduction

Overview

Devices	Page	Application	Standards	Used in		
				Non-residential buildings	Residential buildings	Industry
	4	For all applications from 0.3 A to 63 A in the tripping characteristics B, C and D with rated breaking capacities of 4500 A, 6000 A and 10000 A acc. to EN 60898-1.	EN 60898-1	✓	✓	--
	6	For all applications from 0.3 A to 125 A with rated breaking capacities 10000 A and 15000 A acc. to EN 60898-1. Applications for universal current from 0.3 A to 63 A, 25 kA version, acc. to EN 60947-2.	EN 60898-1/-2 EN 60947-2 UL 1077 CSA 22.2 GB 10963.1/2	--	✓	✓
	9	For socket outlet and lighting circuits in all building installations. The plug-in terminals offer easy front connection for manual insertion of conductors, which considerably reduces mounting times.	EN 60898-1	✓	✓	--
	10	For socket outlet and lighting circuits in all building installations where a switchable neutral conductor is required. The miniature circuit breaker 1+N saves space in the distribution board.	EN 60898-1	✓	✓	✓
	12	Auxiliary switches, fault signal contacts, shunt trips, undervoltage releases for higher system availability, RC units for personal safety and remote controlled mechanisms for remote switching.		✓	--	✓
	17	Busbars in 10 mm ² and 16 mm ² save space in the distribution board and time during mounting. Busbars in 18 mm ² and 25 mm ² versions acc. to UL 508 and CSA.	UL 508	✓	✓	✓
	28	Notes for configuration, dimensioning and extended technical specifications.				
	109	Miniature circuit breakers can be used as "branch circuit protection" and are approved for the connection type "same polarity" and "opposite polarity" in the characteristics B, C and D acc. to UL489, from 0.3 to 63 A.	UL 489	✓	✓	✓

Devices	Page	Application	Standards	Used in		
				Non-residential buildings	Residential buildings	Industry
 <p>SHU 5SP3 main miniature circuit breakers</p>	119	Voltage-independent selective main miniature circuit breakers (SHU) in the precounter area support downstream miniature circuit breakers by providing better current limitation.	DIN VDE 0641-21	✓	✓	--
 <p>Circuit breaker terminals</p>	129	Circuit breaker terminals are used for short-circuit protection or for protection against overload and short circuits in auxiliary and control circuits downstream of control transformers.		--	--	✓

Miniature Circuit Breakers

5SL miniature circuit breakers

Overview

The 5SL miniature circuit breakers are intended for use up to 6 kA/10 kA. These devices have system features that are characteristic of all Siemens miniature circuit breakers.

They are also suitable for the quick and easy mounting of additional components, such as auxiliary switches and fault signal contacts. The 5SL4 miniature circuit breakers can also be combined with shunt trips, undervoltage releases and arc fault detection devices.

To facilitate cable entry, the devices are equipped with rectangular terminals for the accommodation of pin busbars with cables up to 35 mm². The rated current range is between 0.3 A and 63 A. The 5SL miniature circuit breakers are available in characteristics B, C and D.

Technical specifications

		5SL3	5SL6	5SL4
Standards		EN 60898-1		
Approvals		www.siemens.com/lowvoltage/certificates		
Tripping characteristic		B, C		B, C, D
Rated voltage U_n	V AC	230/400		
Operational voltage				
• Min.	V AC/DC per pole	24		
• Max.	V AC V DC/pole	250/440 60 ¹⁾		60 ¹⁾²⁾
Rated making and breaking capacity				
• I_{cn} acc. to IEC/EN 60898-1	kA AC	4.5	6	10
• I_{cu} acc. to IEC/EN 60947-2	kA AC	4.5	6	10
Insulation coordination				
• Rated insulation voltage	V AC	250/440		
• Pollution degree for overvoltage category		2/III		
Rated frequency	Hz	50/60		
Touch protection	Acc. to EN 50274	Yes		
Handle end position, sealable		Yes		
Degree of protection		IP20 with connected conductors, IP40 in the area of the handle with distribution cover		
CFC and silicone-free		Yes		
Conductor cross-sections				
• 1-wire				
- Solid ($\leq 10 \text{ mm}^2$) / stranded ($\geq 16 \text{ mm}^2$)	mm ²	0.75 ... 35		
- Finely stranded with non-insulated end sleeve	mm ²	0.75 ... 25		
- Finely stranded with insulated end sleeve	mm ²	0.75 ... 25		
- Finely stranded without end sleeve	mm ²	1 ... 35		
• 2-wire, same cross-section, same conductor type				
- Solid ($\leq 10 \text{ mm}^2$) / stranded ($\geq 16 \text{ mm}^2$)	mm ²	0.75 ... 10		
- Finely stranded with non-insulated end sleeve	mm ²	0.75 ... 4		
- Finely stranded with insulated end sleeve	mm ²	0.75 ... 4		
- Finely stranded without end sleeve	mm ²	1 ... 4		
• 1-wire + busbar (pin thickness 1.5 mm)				
- Solid ($\leq 10 \text{ mm}^2$) / stranded ($\geq 16 \text{ mm}^2$)	mm ²	10 ... 25		
- Finely stranded with non-insulated end sleeve	mm ²	6 ... 25		
- Finely stranded with insulated end sleeve	mm ²	6 ... 16		
Terminals	± screw (Pozidriv)	2		
• Terminal tightening torque	Nm	2.5 ... 3		
Mounting position		Any		
Service life, on average, with rated load		20000 actuations		
Storage temperature	°C	-40 ... +75		
Ambient temperature	°C	-25 ... +45, occasionally +55, max. 95 % humidity		-25 ... +55, max. 95 % humidity
Resistance to climate	Acc. to IEC 60068-2-30	6 cycles		

¹⁾ The operational voltage 60 V DC/pole takes into account a battery charging voltage with a peak value of 72 V.

²⁾ Except: Characteristic C: 0.3 ... 1A, characteristic D: 0.3 ... 2A

Dimensional drawings

5SL3, 5SL4, 5SL6

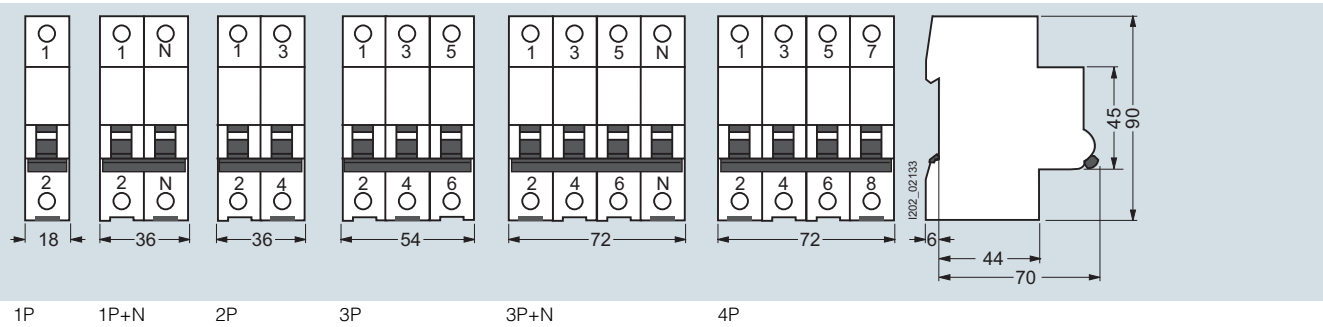

Circuit diagrams

Graphical symbols

5SL3, 5SL4, 5SL6

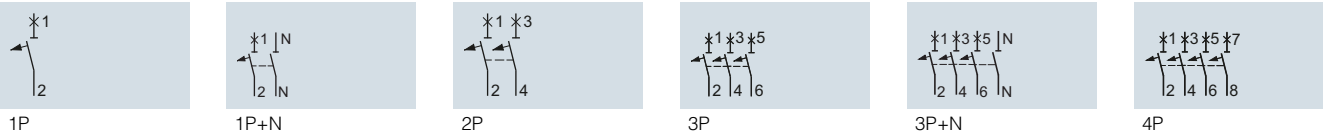

Miniature Circuit Breakers

5SY and 5SP miniature circuit breakers

Overview

MCBs are used to protect systems and installations in buildings and for industrial applications.

Used in industrial applications and plant engineering, miniature circuit breakers can be supplemented with additional components, such as auxiliary switches, fault signal contacts, shunt trips, undervoltage releases, remote controlled mechanisms, RC units, and arc fault detection devices.

The devices are approved for worldwide use according to IEC standards for power supply systems up to 250/440 V AC. 72 V DC per pole is permitted in DC systems.

For North America, there is an additional approval according to UL 1077 for use as "supplementary protectors" in systems up to 480/277 V AC. For use in ship building, the devices also have numerous certifications according to shipping classifications; BV, DNV, GL and LRS. Information on this can be found in the Internet: www.siemens.com/lowvoltage/certificates

Technical specifications

		5SY6	5SY4	5SY5	5SY7	5SY8	5SP4
Standards		EN 60898-1	EN 60898-1	EN 60898-2	EN 60898-1	EN 60947-2	EN 60898-1
Approvals		www.siemens.com/lowvoltage/certificates					
Rated voltage U_n	V AC	230/400	230/400	230/400	230/400	230/400	230/400
	V DC	--	--	220/440/ 880 ⁵⁾	--	--	--
Operational voltage							
Acc. to EN 60898-1/-2 and EN 60947-2	Min. V AC/DC/pole	24	24	24	24	24	24
	Max. V DC/pole	72 ⁴⁾	72 ⁴⁾	250	72 ⁴⁾	72 ⁴⁾	72
	Max. V AC	250/440	250/440	250/440	250/440	250/440	250/440
Acc. to UL 1077 and CSA C22.2 No.235	Max. V AC	480Y/277	480/277	--	480/277	480/277	480/277
	Max. V DC	60	60	--	--	--	--
Breaking capacity¹⁾							
• I_{cn} acc. to IEC/EN 60898-1	kA AC	6	10	10	15	--	10
	kA DC	10	10	10	15	--	10
• I_{cu} acc. to IEC/EN 60898-2	kA AC	30 ... 10 ¹⁾	35 ... 10 ¹⁾	35 ... 10 ¹⁾	50 ... 15 ¹⁾	70 ... 20 ¹⁾	10
	kA DC	15	15	15	15	15	15
• Acc. to UL1077 and CSA C22.2 No.235	kA AC	5	5	--	5	5	5
Insulation coordination							
• Rated insulation voltage	V AC	250/440	--	250	--	--	--
	V DC/pole	--	--	--	--	--	--
Rated frequency	Hz	50/60					
Pollution degree for overvoltage category		3/III ³⁾					
Touch protection	Acc. to EN 50274	Yes					
Handle end position, sealable		Yes					
Degree of protection	Acc. to EN 60529	IP20 with connected conductors, IP40 in the area of the handle with distribution cover					
CFC and silicone-free		Yes					
Mounting							
• Snap-on fixing system		Yes					--
	• Standard mounting rail and screw fixing	--					Yes
Terminals		± screw (Pozidriv)	2				--
• Tunnel terminals at both ends		--					Yes
	• Combined terminals at both ends	Yes					--
• Terminal tightening torque	Nm	2.5 ... 3					2.5 ... 3.5
	lb/in	22 ... 26					22 ... 31
Conductor cross-sections							
• Solid and stranded	mm ²	See 5SY conductor cross-sections					4 ... 50
	mm ²						1.5 ... 35
• AWG cables (Cu 60/75 °C $I_n \leq 40$ A; 60 °C $I_n > 40$ A)	AWG	14 ... 4					14 ... 2
Mains connection							
• AC		Any					
	• DC	Any		²⁾	Any		
Mounting position		Any					
Service life		Actuations	20000				
On average, with rated load		Actuations	10000, for 5SY5 at 40 A, 50 A and 63 A				
Ambient temperature		°C	-25 ... +55, max. 95 % humidity				
Storage temperature		°C	-40 ... +75				
Resistance to climate	Acc. to IEC 60068-2-30	6 cycles					
Shock	Acc. to IEC 60068-2-27	m/s ²	150 at 11 ms half-sine				
Resistance to vibrations	Acc. to IEC 60068-2-6	m/s ²	50 at 25 ... 150 Hz and 60 at 35 Hz (4 sec)				

¹⁾ For detailed information, see page 28.

²⁾ Ensure compliance with the specified polarity when connecting DC.

³⁾ 5SY5 4.. 4-pole, degree of pollution 2 at overvoltage category II.

⁴⁾ Except: C/D 0.3 A ... 0.5 A

⁵⁾ 5SY54.. 4-pole 880 V is not a standardized voltage acc. to EN 60898-1, suitable for max. 1000 V DC, if the four poles are connected in series.

5SY conductor cross-sections

Number of connected conductors	Solid ($\leq 10 \text{ mm}^2$) / Stranded ($\geq 16 \text{ mm}^2$)		Finely stranded with insulated end sleeve ³⁾		Finely stranded without end sleeve ⁴⁾		
	mm ²						
1 conductor at front (+ busbar ²⁾ rear)	mm ²	0.75 ... 35		0.75 ... 25		1 ... 25	
1 conductor at rear	mm ²	0.75 ... 25		0.75 ... 16		1 ... 16	
2 conductors at front ¹⁾ (+ busbar ²⁾ rear)	mm ²	0.75 ... 10		0.75 ... 6		1 ... 6	
2 conductors at rear ¹⁾	mm ²	0.75 ... 6		0.75 ... 4		1 ... 4	
1 conductor at front/1 conductor at rear	mm ²	f: 0.75 ... 16	r: 0.75 ... 25	f: 0.75 ... 16	r: 0.75 ... 16	f: 1 ... 16	r: 1 ... 16
	mm ²	f: 25	r: 0.75 ... 16	f: 25	r: 0.75 ... 6	f: 25	r: 1 ... 6
	mm ²	f: 35	r: 0.75 ... 10				
1 conductor at front/2 conductors at rear ¹⁾	mm ²	f: 0.75 ... 35	r: 0.75 ... 6	f: 0.75 ... 16	r: 0.75 ... 4	f: 1 ... 16	r: 1 ... 4
	mm ²			f: 25	r: 0.75 ... 2.5	f: 25	r: 1 ... 2.5
2 conductors at front ¹⁾ /1 conductor at rear	mm ²	f: 0.75 ... 10	f: 0.75 ... 25	f: 0.75 ... 6	r: 0.75 ... 16	f: 1 ... 6	r: 1 ... 16
2 conductors at front ¹⁾ /2 conductors at rear ¹⁾	mm ²	f: 0.75 ... 10	r: 0.75 ... 6	f: 0.75 ... 6	r: 0.75 ... 4	f: 1 ... 6	r: 1 ... 4

¹⁾ Only conductors of the same cross-section and same conductor type.

²⁾ When bus mounting with pin busbars 5ST36..., 5ST37..., the busbars are connected only in the rear terminal area.

³⁾ According to DIN 46228-4:1990, there is no finger-safety when using end sleeves with 18 mm.

⁴⁾ The general installation regulations must be observed; finely stranded conductors must be twisted before being inserted into the terminal; no individual copper fibers are allowed to project after connecting to the terminal.

Miniature Circuit Breakers

5SY and 5SP miniature circuit breakers

Dimensional drawings

5SY

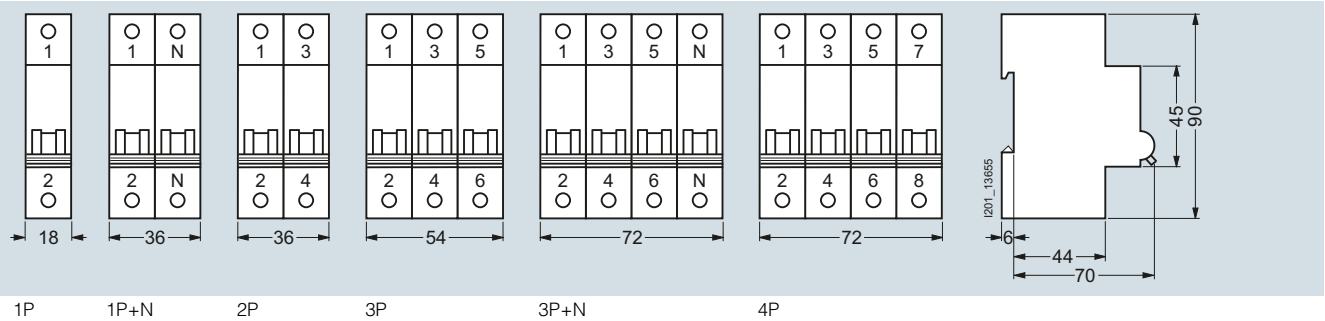

5SP

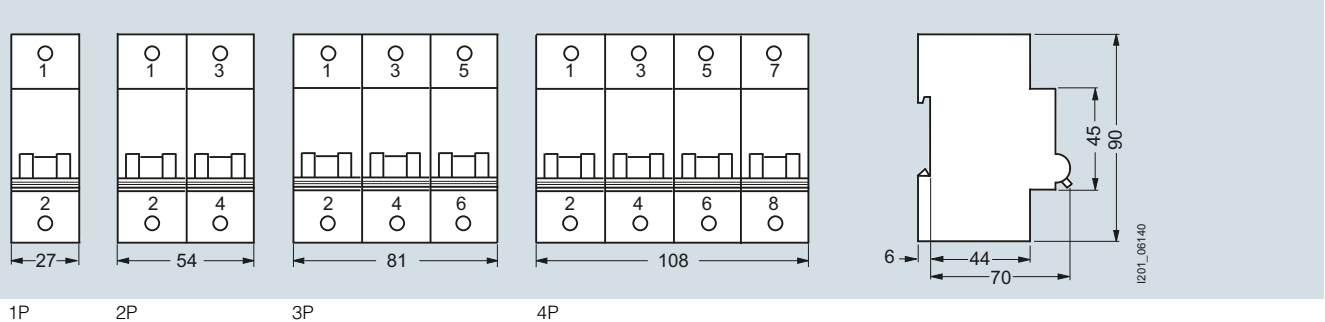

Circuit diagrams

Graphical symbols

5SY4, 5SY6, 5SY7, 5SY8

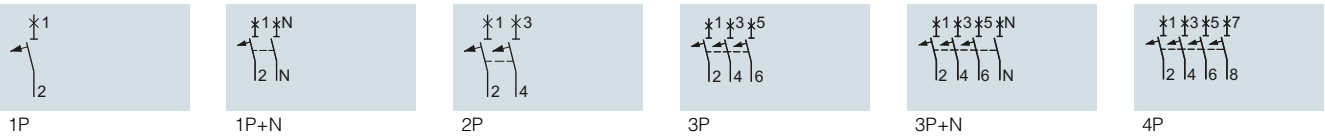

5SP4

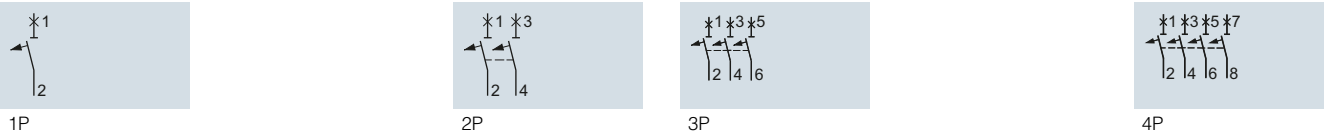

5SY5



5SJ6...-KS miniature circuit breakers, with plug-in terminals

Overview

Miniature circuit breakers with plug-in terminals are used for the protection of socket outlets and lighting circuits with the most common rated currents of 10 to 20 A.

Technical specifications

			5SJ6...-KS
Standards			EN 60898-1
Approvals			www.siemens.com/lowvoltage/certificates
Rated voltage U_n		V AC	230/400
Operational voltage			
• Min.		V AC/DC/pole	24
• Max.		V AC	250/440
		V DC/pole	60 ¹⁾
Rated making and breaking capacity	Acc. to EN 60898-1	kA AC	6
Insulation coordination			
• Rated insulation voltage		V AC	250/440
• Pollution degree for overvoltage category			2/III
Rated frequency		Hz	50/60
Touch protection	Acc. to EN 50274		Yes
Handle end position , sealable			Yes
Degree of protection	Acc. to EN 60529		IP20 with connected conductors, IP40 in the area of the handle with distribution cover
CFC and silicone-free			Yes
Terminals			Screwless terminals on the outgoing terminals for 1.5 ... 4 mm ²
Conductor cross-sections			
• Top, plug-in terminals			
- Solid, stranded and finely stranded, without end sleeve		mm ²	1.5 ... 4
- Finely stranded, with end sleeve		mm ²	1.5 ... 2.5
• Bottom, tunnel terminal	± screw (Pozidriv)		2
- Solid, stranded or finely stranded, with end sleeve		mm ²	0.75 ... 25
Mounting position			Any
Service life			20000 actuations
On average, with rated load			
Ambient temperature		°C	-25 ... +45, occasionally +55, max. 95 % humidity
Storage temperature		°C	-40 ... +75
Resistance to climate	Acc. to IEC 60068-2-30		6 cycles

¹⁾ The operational voltage 60 V DC/pole takes into account a battery charging voltage with a peak value of 72 V.

Dimensional drawings

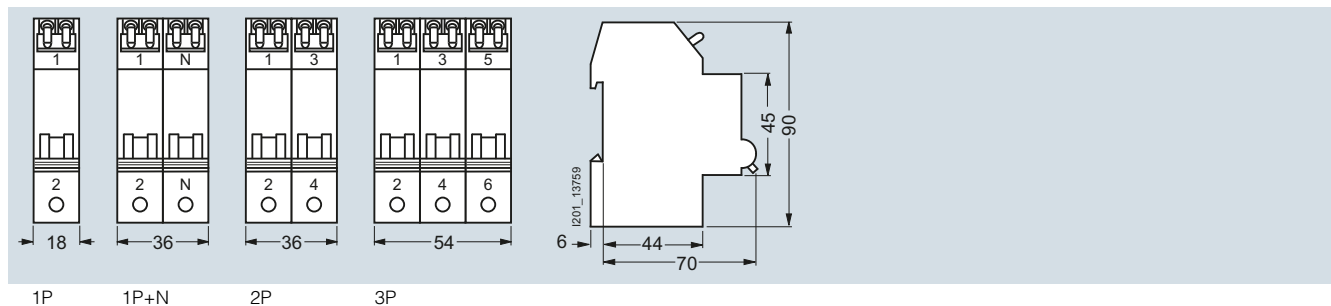

Circuit diagrams

Graphical symbols

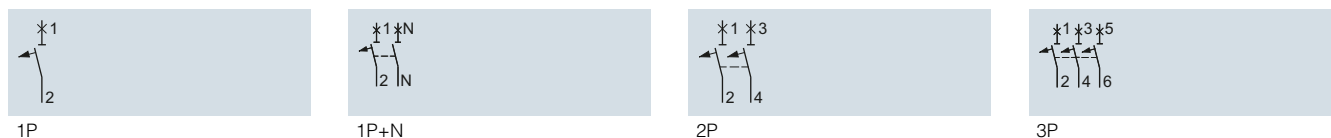

Miniature Circuit Breakers

5SY miniature circuit breakers, 1+N in 1 MW

Overview

These miniature circuit breakers are used for the protection of systems and installations with switched neutral conductors in distribution boards with little space. They are just a single modular width.

Compact busbars facilitate installation in space-saving distribution boards.

Technical specifications

		5SY30..	5SY60..
Standards		EN 60898-1	
Approvals		www.siemens.com/lowvoltage/certificates	
Rated voltage U_n	V AC	230	
Operational voltage			
• Min.	V AC/DC	24	
• Max.	V AC	250	
	V DC/pole	72	
Rated making and breaking capacity I_{cn}	kA AC	4.5	6
Insulation coordination			
• Rated insulation voltage	V AC	250	
• Pollution degree for overvoltage category		2/III	
Rated frequency	Hz	50/60	
Touch protection	Acc. to EN 50274	Yes	
Handle end position, sealable		Yes	
Degree of protection	Acc. to EN 60259	IP20 with connected conductors, IP40 in the area of the handle with distribution cover	
CFC and silicone-free		Yes	
Terminals	± screw (Pozidriv)	2	
• Solid and stranded, top and bottom terminal	mm ²	0.75 ... 16	
• Finely stranded, with end sleeve, top and bottom terminal	mm ²	0.75 ... 10	
• Terminal tightening torque	Nm	2.0 ... 2.5	
Mounting position		Any	
Service life	On average, with rated load	20000 actuations at 2A/4A and 40A: 8000 actuations	
Ambient temperature	°C	-25 ... +45, occasionally +55, max. 95 % humidity	
Storage temperature	°C	-40 ... +75	
Resistance to climate	Acc. to IEC 60068-2-30	6 cycles	
Resistance to vibrations	Acc. to IEC 60068-2-6 m/s ²	50 at 25 ... 150 Hz and 60 at 35 Hz (4 sec)	

Dimensional drawings

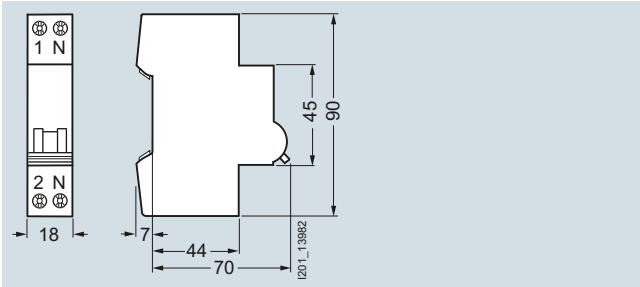

1P+N
N pole, right

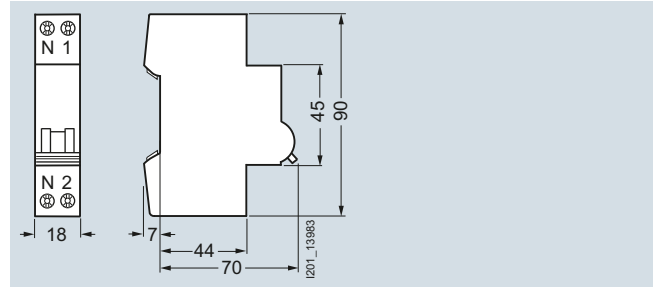

1P+N
N pole, left

**5ST36
Pin spacing in MW**

Dimensions of side view in mm (approx.)

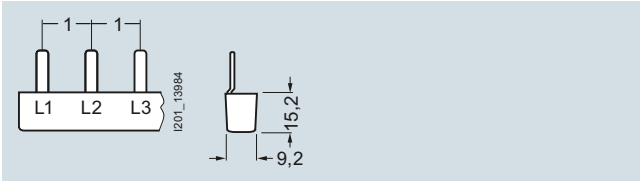

5ST3613
5ST3614
5ST3615

**5ST37
Pin spacing in MW**

Dimensions of side view in mm (approx.)

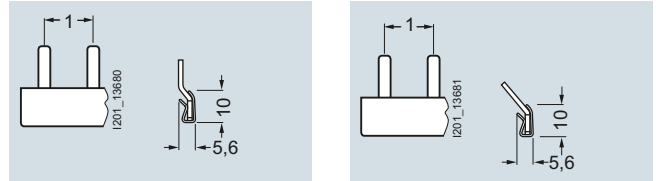

5ST3762
5ST3764

5ST3763
5ST3765

Circuit diagrams

Graphical symbols

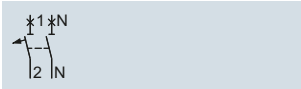

1P+N
N pole, right

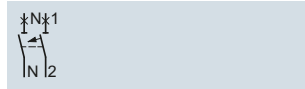

1P+N
N pole, left

Miniature Circuit Breakers

Additional components

Overview

The Siemens mounting concept supports the combination of all 5ST3 additional components with Siemens 5SY and 5SP miniature circuit breakers and with 5SU1 RCBOs.

5SL and 5SY60.. miniature circuit breakers are suitable for mounting auxiliary switches and fault signal contacts. Auxiliary switches can also be mounted on 5TE8 flush-mounting circuit breakers and 5SG71 MINIZED switch disconnectors.

Auxiliary switches (AS)

The auxiliary switch (AS) always signals the contact position of the miniature circuit breaker, regardless of whether the miniature circuit breaker was tripped manually or as the result of a fault. An additional version is also available for the switching of small currents and voltages for the control of programmable control systems (PLCs) acc. to EN 61131-2. The auxiliary switch with test button enables the testing of control circuits without the need to switch the miniature circuit breaker.

Fault signal contacts (FC)

The fault signal contact (FC) signals the automatic tripping of the miniature circuit breaker in the event of a fault, such as an overload or a short circuit. If the fault signal contact is activated, the contact position does not change if the miniature circuit breaker is tripped manually. Fault signal contacts with TEST and RESET buttons enable the testing of control circuits without the need to trip the miniature circuit breaker. The red RESET button integrated in the handle also indicates the automatic tripping of the MCB. The signal can be acknowledged manually using the RESET button.

Shunt trips (ST)

Shunt trips are used for the remote tripping of a miniature circuit breaker.

Undervoltage releases (UR)

Undervoltage releases are integrated (e.g. in EMERGENCY-OFF loops), thus ensuring that the MCB trips in the event of an emergency, which, in turn, ensures disconnection of the control circuit according to EN 60204. In the event that the voltage is interrupted or too low, it also trips, i.e. prevents activation of the MCB.

Remote controlled mechanisms (RC)

Remote controlled mechanisms are used for the remote ON/OFF switching of miniature circuit breakers and the remote ON switching of RC units, as well as the local manual switching of these devices. A blocking function permits maintenance work. In the event that a miniature circuit breaker or RC unit is tripped, an acknowledgment must be carried out prior to switching back on. The remote controlled mechanism has an operating mode selector switch with the functions: "Locked", "Manual" and "Remote Switching".

Selector switch position:

OFF: The remote controlled mechanism is switched off, blocked mechanically and can be sealed and/or locked.

RC OFF: Only manual operation is possible.

RC ON: Both manual and remote operation are possible.

In the event that a device is tripped by a fault (RC units, miniature circuit breakers), the handle of the basic device and remote controlled mechanism switches to the OFF position. The operator must then acknowledge the tripping by resetting the remote controlled mechanism (OFF command) before it can be reactivated. This serves the safety of the installation or to protect personnel during maintenance work.

In an RC unit/miniature circuit breaker combination, the RC unit is switched on asynchronously, i.e. prior to the miniature circuit breaker. The RC units for 5SY and 5SP4 can be switched ON via the MCB handle jumper using the supplied actuator attachment. There is no need to switch off the RC unit via the remote controlled mechanism as the MCB contacts ensure disconnection of the electrical circuit.

The switching frequency is max. 2 actuations per minute. If this actuation frequency is exceeded it may cause internal tripping of the remote controlled mechanism as a protection against possible overload. In this case, the remote controlled mechanism must be switched OFF at the function selector switch and not switched back on again for at least 5 minutes. More additional 5ST3 ... components, such as AS, FC, ST and UR, can be added to the right-hand side of the remote controlled mechanism in line with the Siemens mounting concept.

RC units

RC units can be combined with miniature circuit breakers of characteristic A, B, C and D. They then form a combination of RCCB and MCB for personnel, fire and line protection. The combinations can be tailored to meet individual requirements.

For information on RC units, see chapter "Residual Current Protective Devices / Arc Fault Detection Devices (AFDDs)" in Catalog LV 10.

Technical specifications

		Auxiliary switches (AS)		Fault signal contacts (FC)
		5ST3010, 5ST3010-2 5ST3011, 5ST3011-2 5ST3012, 5ST3012-2	5ST3013 ¹⁾ , 5ST3013-2 ²⁾ 5ST3014 ¹⁾ , 5ST3014-2 ²⁾ 5ST3015 ¹⁾ , 5ST3015-2 ²⁾	5ST3020, 5ST3020-2 5ST3021, 5ST3021-2 5ST3022, 5ST3022-2
Standards		EN 62019; IEC/EN 60947-5-1; UL 1077; CSA C22.2 No. 235		
Approvals		www.siemens.com/lowvoltage/certificates		
Short-circuit protection		Miniature circuit breaker or gG 6 A fuse		
Contact load				
• Min.		50 mA, 24 V	1 mA/5 V DC	50 mA, 24 V
• Max.		--	¹⁾ = 100 mA/30 V DC ²⁾ = 50 mA/30 V DC	--
• 400 V AC, AC-14, NO	A	2	--	2
• 230 V AC, AC-14, NO	A	6	--	6
• 400 V AC, AC-13, NC	A	2	--	2
• 230 V AC, AC-13, NC	A	6	--	6
• 220 V DC, DC-13, NO+NC	A	1	--	1
• 110 V DC, DC-13, NO+NC	A	1	--	1
• 60 V DC, DC-13, NO+NC	A	3	--	3
• 24 V DC, DC-13, NO+NC	A	6	--	6
Service life, on average, with rated load		20000 actuations	20000 actuations	20000 actuations
Conductor cross-sections	mm ² AWG	0.5 ... 2.5 22 ... 14	0.5 ... 2.5 22 ... 14	0.5 ... 2.5 22 ... 14
Terminals				
• Terminal tightening torque	Nm lb/in	0.5 4.5	0.5 4.5	0.5 4.5
Rated frequency	Hz	50/60		
Mounting position		Any	Any	Any
Ambient temperature	°C	-25 ... +55	-25 ... +55	-25 ... +55
Storage temperature		-40 ... +75	-40 ... +75	-40 ... +75
Resistance to climate	Acc. to IEC 60068-2-30	Cycles	28	
Shock	Acc. to IEC 60068-2-27	m/s	50 at 11 ms half-sine	
Resistance to vibrations	Acc. to IEC 60068-2-6	m/s ²	50 at 10 ... 150 Hz	
		Undervoltage releases (UR) 5ST304.	Shunt trips (ST) 5ST3030 5ST3031	Remote controlled mechanisms (RC) 5ST3050, 5ST3052
Standards		EN 60947-1		
Rated voltages U_n	V AC V DC	230 24, 110	110 ... 415 24 ... 48 110 24 ... 48	230 --
• Operating range U_n		0.85 ... 1.1 × U_n	0.7 ... 1.1 × U_n	0.9 ... 1.15 × U_n
• Rated frequency f_n	Hz	--	50 ... 60	50 ... 60
Response limits				
• Tripping		< 0.35 ... 0.7 × U_n	--	--
Short-circuit protection		Miniature circuit breakers B/C 6 A or fuse gG 6 A		
Minimum contact load		50 mA, 24 V	50 mA, 24 V	--
Tripping operations		max. 2000	max. 2000	--
Service life, on average, with rated load		20000 actuations	20000 actuations	20000 actuations 5000 at RC unit
Conductor cross-sections	mm ² AWG	0.5 ... 2.5 22 ... 14	0.5 ... 2.5 22 ... 14	0.5 ... 2.5 22 ... 14
Terminals				
• Terminal tightening torque	Nm lb/in	0.8 6.8	0.8 6.8	0.4 ... 0.5 4.5
Mounting position		Any	Any	Any
Ambient temperature	°C	-25 ... +55	-25 ... +55	-20 ... +55
Storage temperature	°C	-40 ... +75	-40 ... +75	-40 ... +75
Resistance to climate	Acc. to IEC 60068-2-30	Cycles	28	
Shock	Acc. to IEC 60068-2-27	m/s	50 at 11 ms half-sine	
Resistance to vibrations	Acc. to IEC 60068-2-6	m/s ²	50 at 10 ... 150 Hz	
Switching frequency		--		2 actuations per minute
Switching duration	s	--		< 2
Minimum command duration	s	--		0.2 continuous command possible
Rated power dissipation	VA	--		No intrinsic consumption, in switching operation 26
Rated frequency	Hz	50/60		
Behavior in the event of control voltage failure		--		No change

Technical specifications for the RC units can be found in chapter "Residual Current Protective Devices / Arc Fault Detection Devices (AFDDs)" in Catalog LV 10.

Miniature Circuit Breakers

Additional components

Dimensional drawings

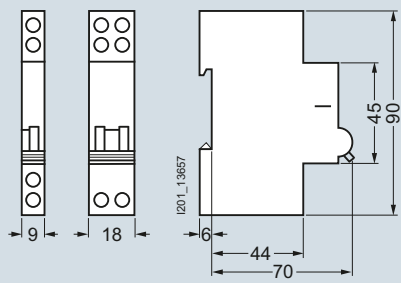

- 5ST3010
- 5ST3011
- 5ST3012
- 5ST3013
- 5ST3014
- 5ST3015
- 5ST3020
- 5ST3021
- 5ST3022
- 5ST3030
- 5ST3031
- 5ST3040
- 5ST3041
- 5ST3042
- 5ST3043
- 5ST3044
- 5ST3045

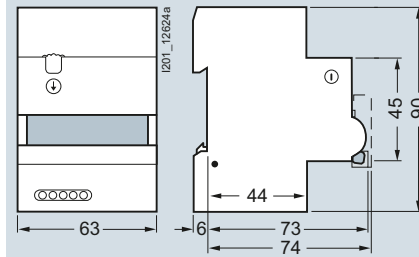

- 5ST3050
- 5ST3052

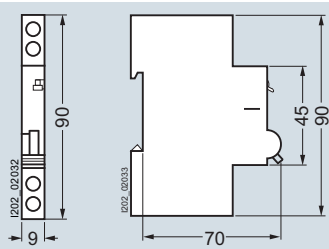

- 5ST3010-2
- 5ST3011-2
- 5ST3012-2
- 5ST3013-2
- 5ST3014-2
- 5ST3015-2

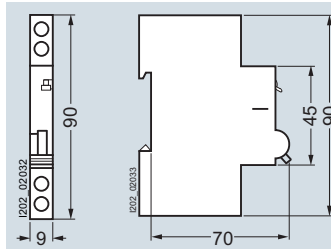

- 5ST3020-2
- 5ST3021-2
- 5ST3022-2

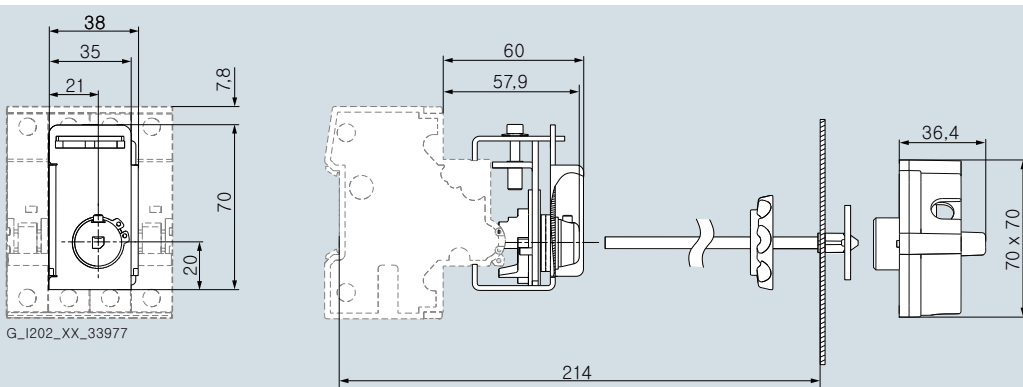

- 5ST3060
- 5ST3061

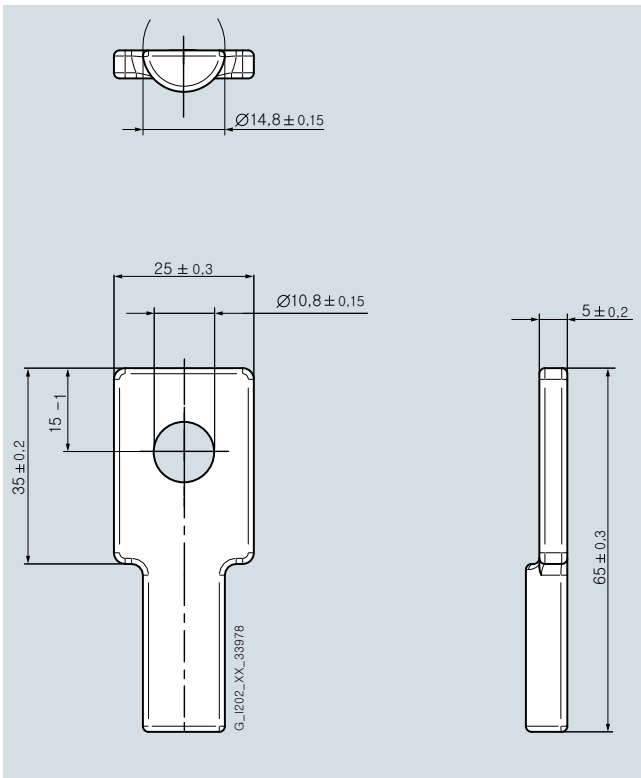

5ST2510

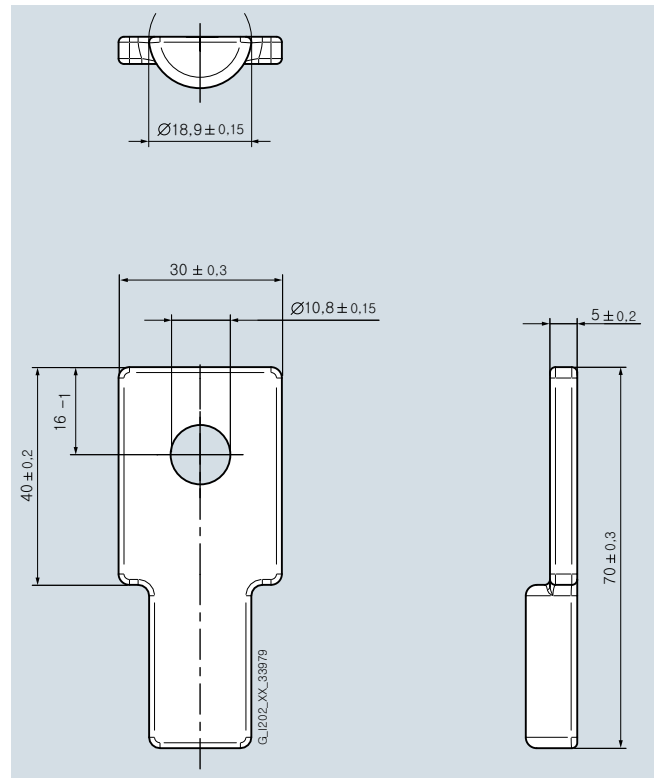

5ST2512

Circuit diagrams

Graphical symbols

Auxiliary switches (AS)

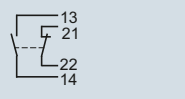

5ST3010
5ST3013
5ST3010-2

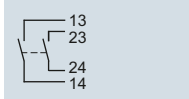

5ST3011
5ST3014
5ST3011-2

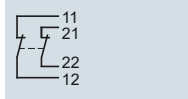

5ST3012
5ST3015
5ST3012-2

Fault signal contacts (FC)

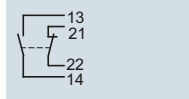

5ST3020
5ST3020-2

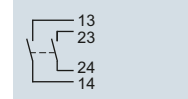

5ST3021
5ST3021-2

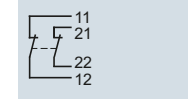

5ST3022
5ST3022-2

Shunt trips (ST)

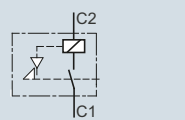

5ST3030
5ST3031

Undervoltage releases (UR)

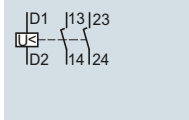

5ST3040
5ST3041
5ST3042

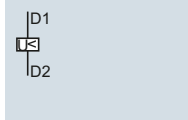

5ST3043
5ST3044
5ST3045

Remote controlled mechanisms (RC)

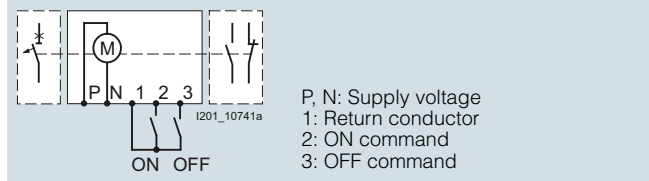

5ST3050
5ST3052

P, N: Supply voltage
1: Return conductor
2: ON command
3: OFF command

Miniature Circuit Breakers

Additional components

More information

The Siemens mounting concept supports the combination of all 5ST3 additional components with miniature circuit breakers of the 5SY, 5SP and 5SL4 series and RCBOs of the 5SU1 series.

5SL and 5SY60.. miniature circuit breakers are suitable for mounting auxiliary switches and fault signal contacts. Auxiliary switches can also be mounted on 5TE8 flush-mounting circuit breakers and 5SG71 MINIZED switch disconnectors.

The diagram shows which additional components can be mounted on either the right or the left.

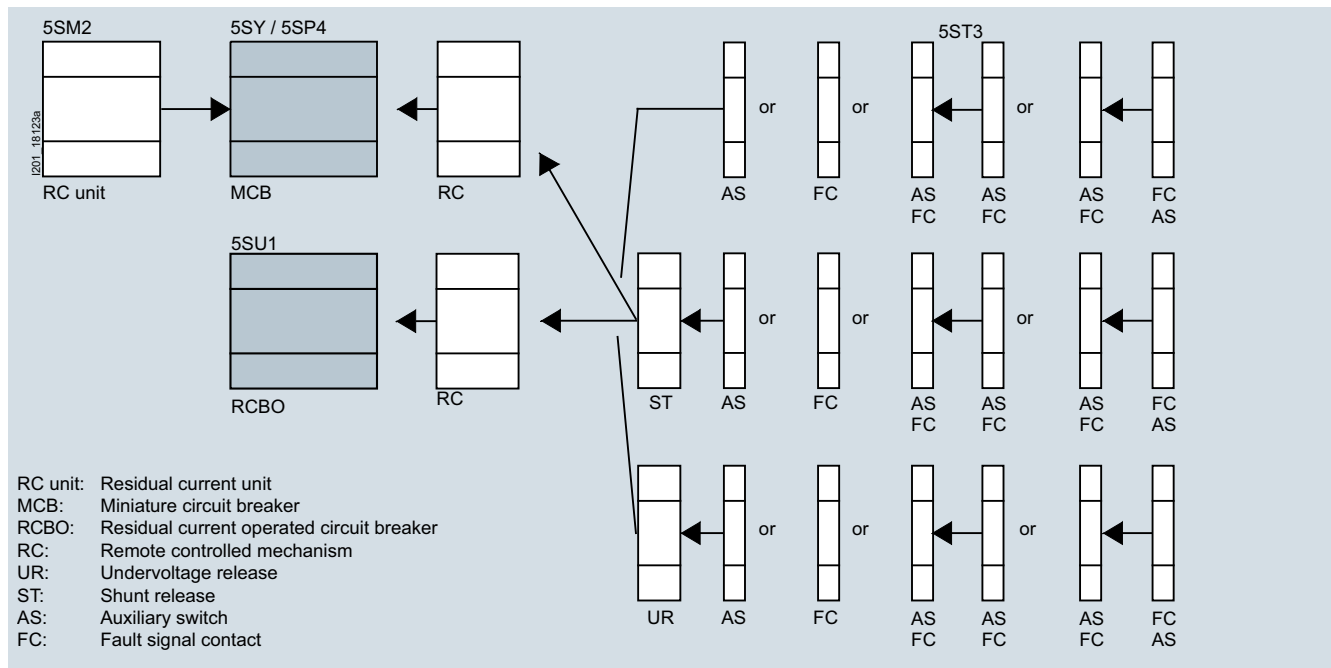

Mounting concept for RCBOs, see chapter "Residual Current Protective Devices / Arc Fault Detection Devices (AFDDs)" in Catalog LV 10.

Overview

The busbar system with pin-type connections can be used for all 5SL6, 5SJ6 ...-KS and 5SY miniature circuit breakers with or without mounted auxiliary switch (AS) or fault signal contact (FC).

Busbars in 10 mm² and 16 mm² versions are available.

With bars that can be cut to length, the 5ST37 busbar system can be tailored to any requirements.

The extremely flexible 5ST36 busbar system with fixed lengths also enables installation in any length as the busbars can be overlapped.

No further need for time-consuming tasks, such as cutting, cutting to length, deburring, cleaning of cut surfaces and mounting of end caps.

Any free pins on the busbars can be made safe by covering with touch protection.

Further information on the bus-mounting of miniature circuit breakers with residual current operated circuit breakers, see [chapter "Residual Current Protective Devices / Arc Fault Detection Devices \(AFDDs\)" in Catalog LV 10.](#)

Technical specifications

			5ST3
Standards	EN 60439-1 (VDE 0660-500): 2005-01		
Busbar material	SF-Cu F 24		
Partition material	Plastic Cycloyl 3600, heat-resistant above 90 °C, flame-retardant, self-extinguishing, free of dioxins and halogens		
Rated operational voltage U_c	V AC	400	
Rated current I_n			
• Cross-section 10 mm ²	A	63	
• Cross-section 16 mm ²	A	80	
Rated impulse withstand voltage U_{imp}	kV	4	
Test pulse voltage (1.2/50)	kV	6.2	
Rated conditional short-circuit current I_{cc}	kA	25	
Resistance to climate			
• Constant atmosphere	Acc. to DIN 50015	23/83; 40/92; 55/20	
• Humid heat	Acc. to IEC 60068-2-30	28 cycles	
Insulation coordination			
• Overvoltage category		III	
• Pollution degree		2	
Maximum busbar current I_S/phase			
• Infeed at the start of the busbar			
- Cross-section 10 mm ²	A	63	
- Cross-section 16 mm ²	A	80	
• Infeed at the center of the busbar			
- Cross-section 10 mm ²	A	100	
- Cross-section 16 mm ²	A	130	

Infeed at the start or end of the busbar

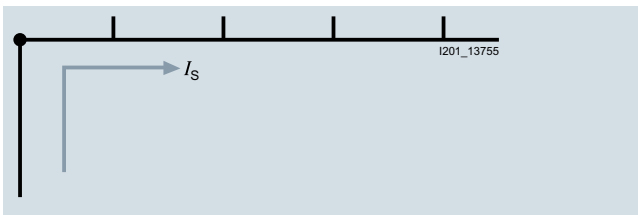

Infeed along the busbar or midpoint infeed

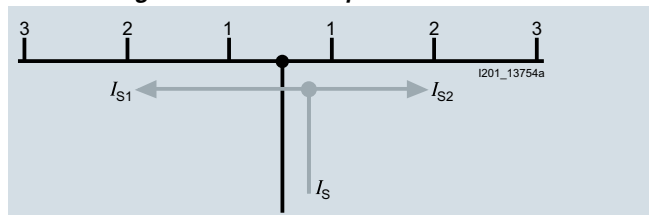

The sum of the outgoing current per branch (1, 2, 3...n) must not be greater than the max. busbar current I_S /phase.

Miniature Circuit Breakers

Busbars

5ST standard busbars

Dimensional drawings

5ST36

Pin spacing in MW (modular width; 1 MW = 18 mm)

Dimensions of side view in mm (approx.)

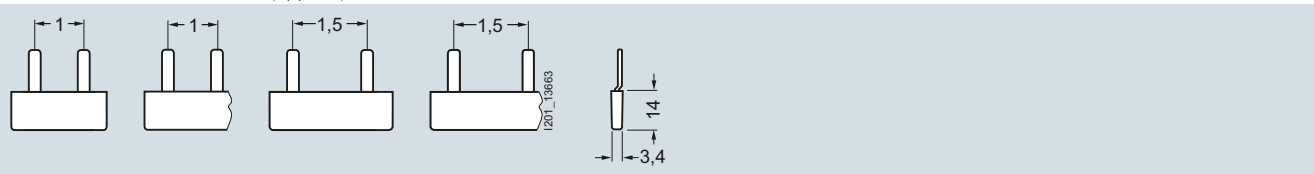

- | | | | |
|---------|---------|---------|---------|
| 5ST3600 | 5ST3601 | 5ST3603 | 5ST3604 |
| 5ST3630 | 5ST3602 | 5ST3633 | 5ST3605 |
| | 5ST3631 | | 5ST3634 |
| | 5ST3632 | | 5ST3635 |

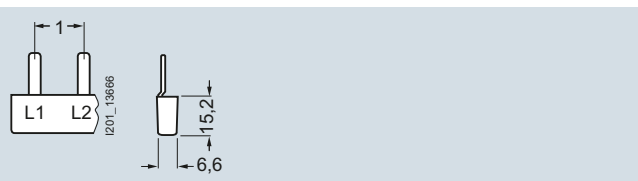

- 5ST3606
5ST3607
5ST3608

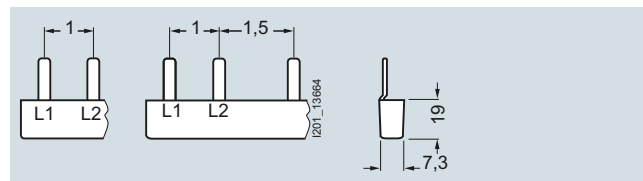

- | | |
|---------|---------|
| 5ST3636 | 5ST3640 |
| 5ST3637 | 5ST3641 |
| 5ST3638 | 5ST3642 |

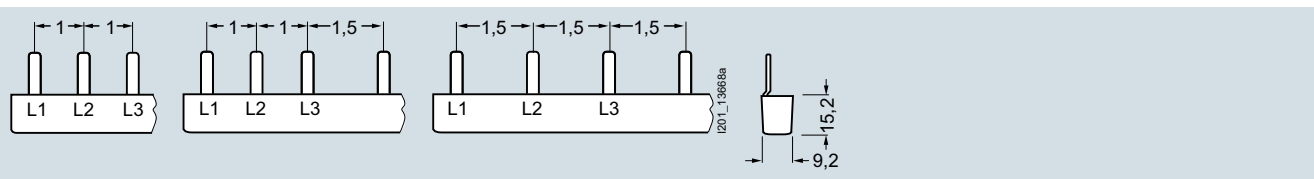

- | | | |
|---------|---------|---------|
| 5ST3613 | 5ST3616 | 5ST3618 |
| 5ST3614 | 5ST3617 | 5ST3620 |
| 5ST3615 | | |
| 5ST3667 | | |

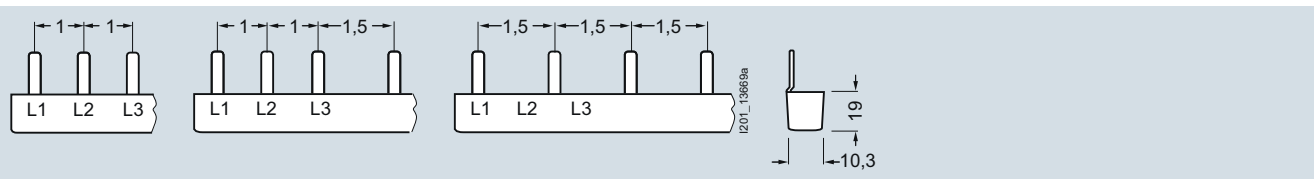

- | | | |
|---------|---------|---------|
| 5ST3643 | 5ST3646 | 5ST3648 |
| 5ST3644 | 5ST3647 | 5ST3650 |
| 5ST3645 | | |
| 5ST3668 | | |

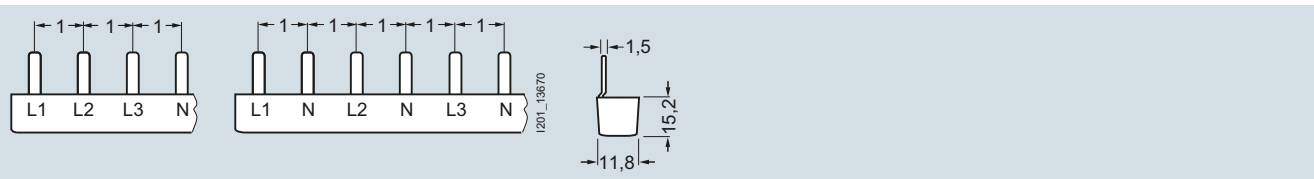

- 5ST3621
5ST3622
- 5ST3623

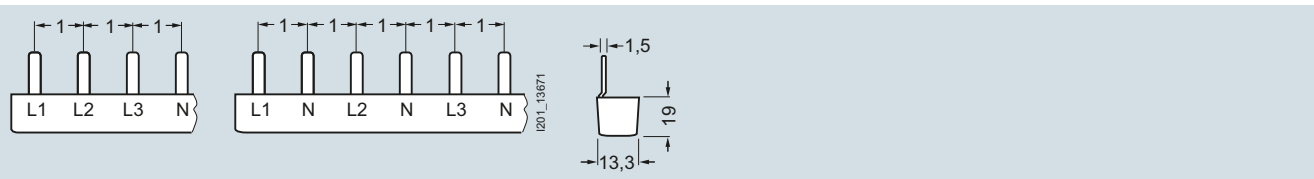

- 5ST3651
5ST3652
- 5ST3653

5ST36
Pin spacing in MW (modular width; 1 MW = 18 mm)

Dimensions of side view in mm (approx.)

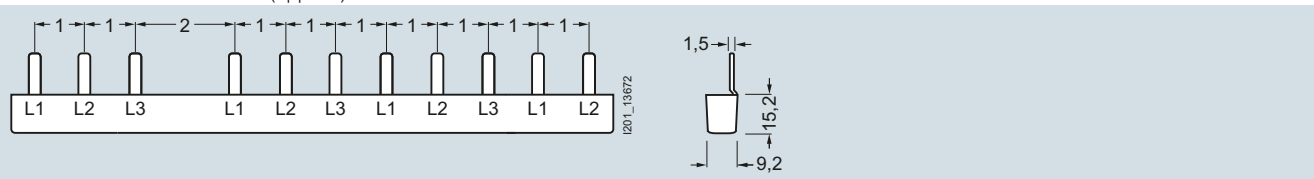

5ST3624

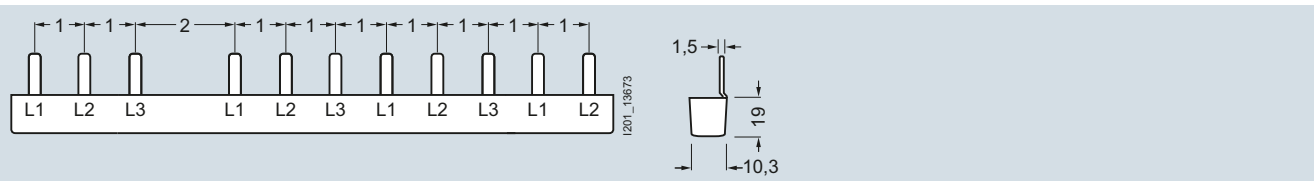

5ST3654

5ST37
Pin spacing in MW (modular width; 1 MW = 18 mm)

Dimensions of side view in mm (approx.)

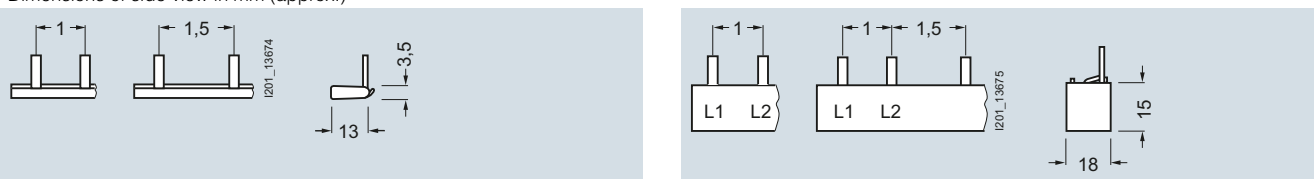

5ST3700 5ST3702
5ST3701 5ST3703
5ST3730 5ST3732
5ST3731 5ST3733
Single-phase Single-phase

5ST3704 5ST3706
5ST3705 5ST3707
5ST3734 5ST3736
5ST3735 5ST3737
Two-phase Two-phase

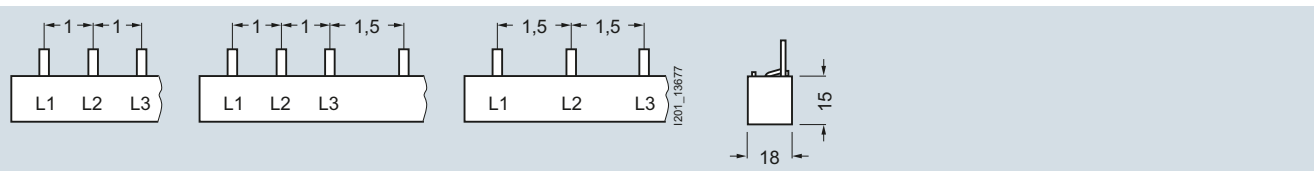

5ST3708 5ST3711 5ST3713
5ST3710 5ST3712 5ST3714
5ST3738 5ST3741 5ST3743
5ST3740 5ST3742 5ST3744

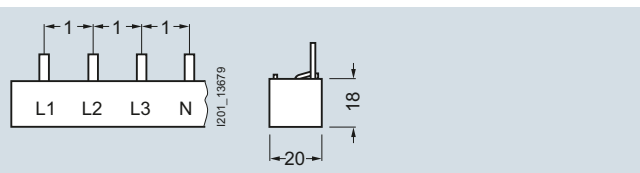

5ST3715
5ST3716
5ST3745
5ST3746

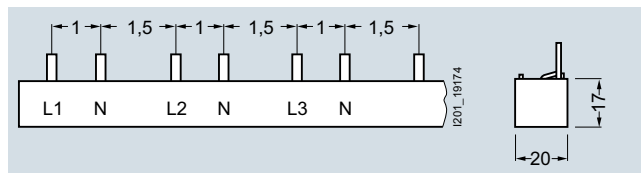

5ST3746-2

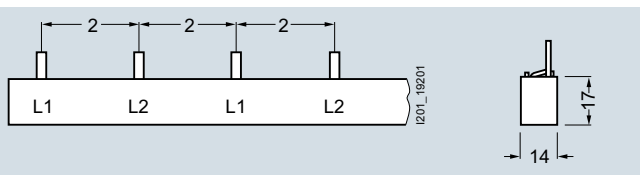

5ST3735-2

Miniature Circuit Breakers

Busbars

5ST standard busbars

5ST37

Pin spacing in MW (modular width; 1 MW = 18 mm)

Dimensions of side view in mm (approx.)

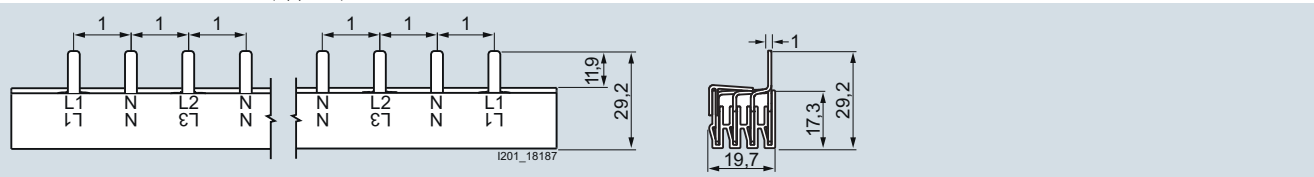

5ST3770-2

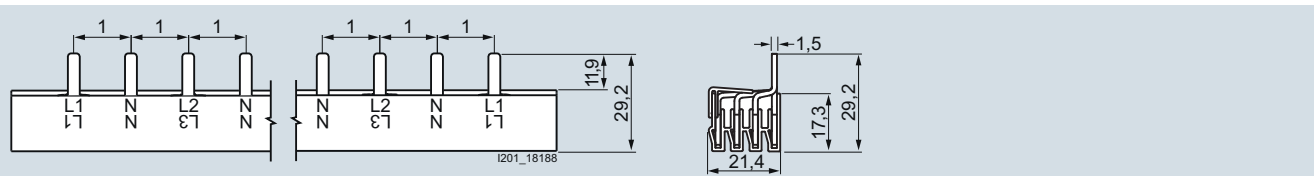

5ST3770-3

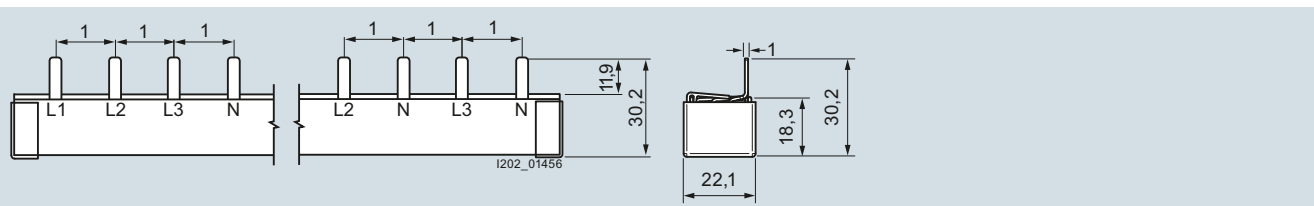

5ST3770-4

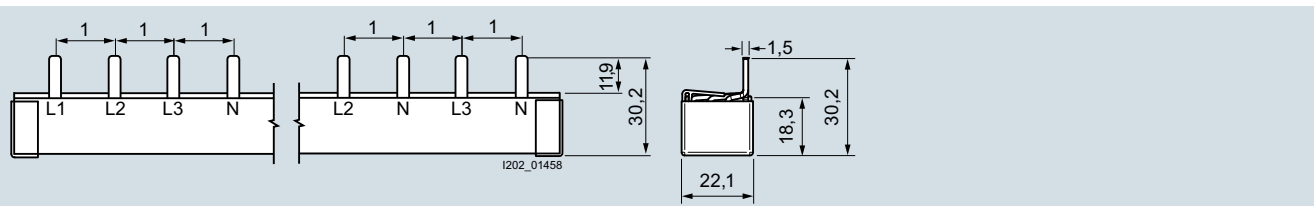

5ST3770-5

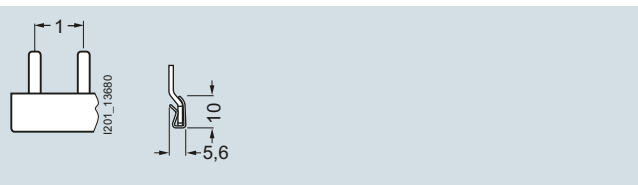

5ST3762
5ST3764

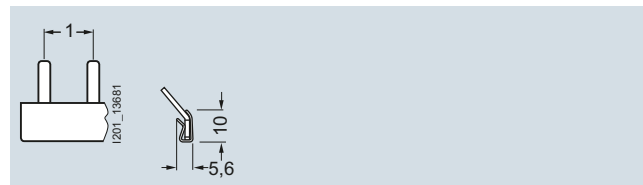

5ST3763
5ST3765

Overview

Products according to UL standards are used in North America, but also in several other countries. This is important in particular for exporting machines or electrical switchgear assemblies and equipment to the USA. Acceptance and delivery are possible only if the relevant UL standards are satisfied.

The 5ST37 busbar system according to UL 508 and CSA is suitable for both universal use worldwide with all 5SY and 5SP miniature circuit breakers for "Supplementary Protection" certified according to UL 1077 and for 3NW and 3NC fuse holders certified according to UL 512. Not approved for use in feeder circuits.

The busbars are available in single-, two- and three-phase versions with different pin spacings and with two cross-sections 18 mm² and 25 mm². Infeed can be directly into the terminals of the miniature circuit breaker or through connection terminals.

The connection terminals are available in two versions – for direct infeed at the busbar or for infeed directly at the miniature circuit breaker/fuse holder. Pins that are not required can be covered with touch protection covers.

Technical specifications

		5ST37...0HG	5ST37...2HG	5ST3770-0HG	5ST3770-1HG		
Standards		UL 508, CSA C22.2 No. 14-M 95 / IEC 60999					
Approvals		UL508 File No. E328403 CSA					
Operational voltage							
• Acc. to IEC	V AC	690					
• Acc. to UL 508	V AC	600					
Rated conditional short-circuit current		kA 10					
• Dielectric strength	kV/mm	25					
• Surge strength	kV	> 9.5					
Max. current		UL	A	--	115		
	IEC	A	--	--	160		
Maximum busbar current I_S/phase							
• Infeed at the start of the busbar	A	80	100	--	--		
• Infeed at the center of the busbar	A	160	200	--	--		
Insulation coordination							
• Overvoltage category		III					
• Pollution degree		2					
Short-circuit current load capability		10000 A RMS sym. 600 V for three circuits					
	18 mm ²	100 000 A RMS sym. for protection with Class J 175 A					
	25 mm ²	100 000 A RMS sym. for protection with Class J 200 A					
Busbar cross-section		mm ² Cu	18	25	--	--	
Infeed		Any					
Conductor cross-sections		Solid	AWG	--	--	10 ... 1/0	10 ... 1
		mm ²	--	--	--	6 ... 35 (Cu 60 °C)	6 ... 50 (Cu 75 °C)
		Stranded	AWG	--	--	10 ... 2	6 ... 35
		mm ²	--	--	--	6 ... 35	
Terminals		± screw (Pozidriv)					
• Terminal tightening torque	Nm	--	--	2	2		
	lb/in	--	--	5	3.5		
		--	--	50	35		

Infeed at the start or end of the busbar

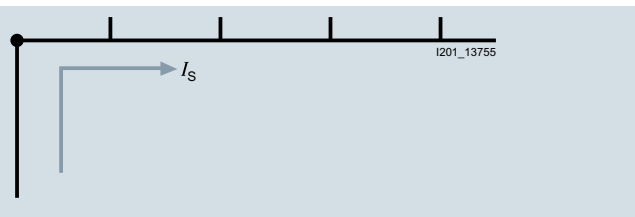

Infeed along the busbar or midpoint infeed

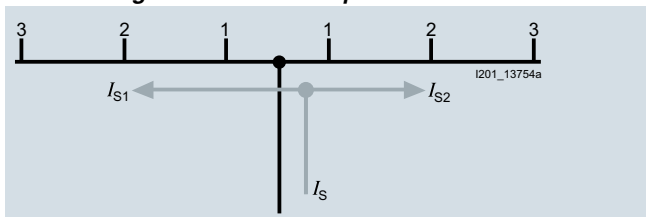

The sum of the outgoing current per branch (1, 2, 3...n) must not be greater than the max. busbar current I_S /phase.

Miniature Circuit Breakers

Busbars

5ST3 busbars acc. to UL 508

Dimensional drawings

5ST37 busbars

Pin spacing in MW (modular width; 1 MW = 18 mm)

Dimensions of side view in mm (approx.)

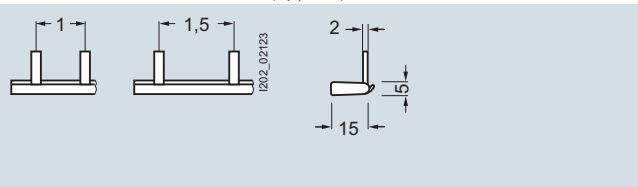

5ST3701-0HG 5ST3703-0HG

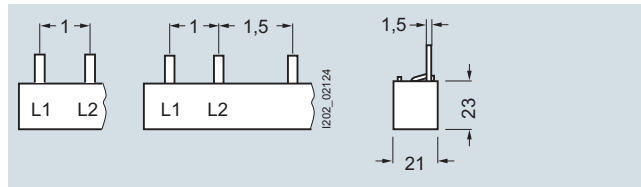

5ST3705-0HG 5ST3707-0HG

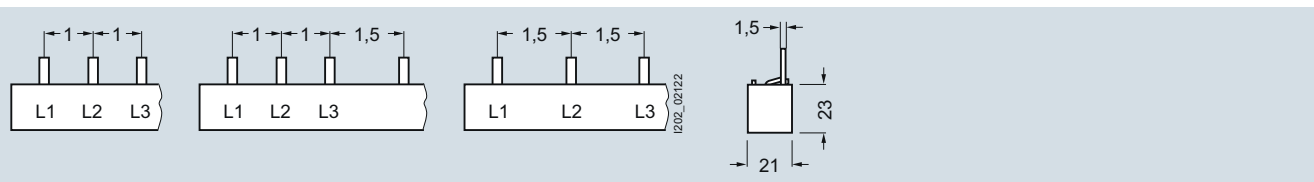

5ST3710-0HG 5ST3712-0HG 5ST3714-0HG

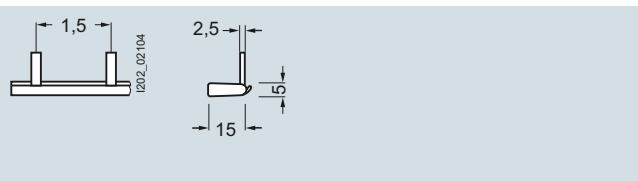

5ST3701-2HG

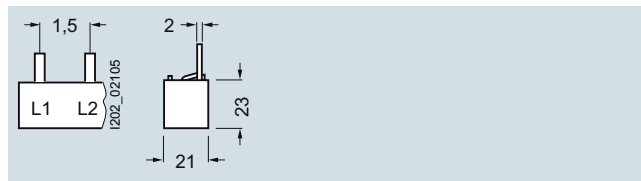

5ST3705-2HG

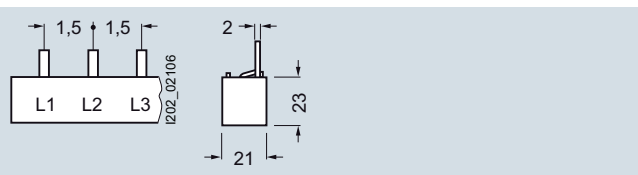

5ST3710-2HG

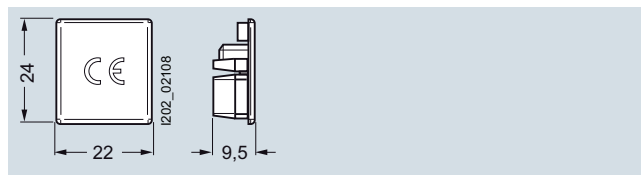

5ST3750-0HG

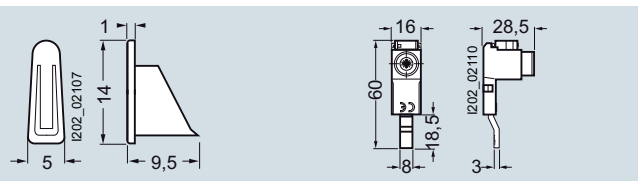

5ST3748-0HG 5ST3770-0HG

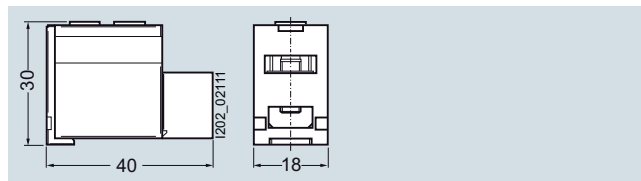

5ST3770-1HG

5ST36 touch guard

Pin spacing in MW (modular width; 1 MW = 18 mm)

Dimensions of side view in mm (approx.)

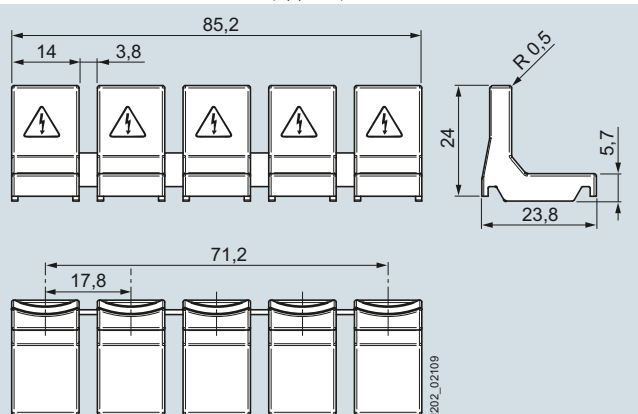

5ST3655-0HG

Overview

Distribution blocks for standard rail mounting

Using distribution blocks it is possible to implement one, two, three and four-phase systems with a rated current of up to 400 A. This allows supply terminals to be divided into several load circuits with different cable cross-sections.

The distribution blocks are made of thermoplastic with electrical and mechanical components, which enables their use under high thermal and mechanical load acc. to IEC 60947-7-1.

Technical specifications

		5ST2501	5ST2502	5ST2503		
Standards, certifications		IEC 60947-7-1				
Degree of protection		IP 20				
Poles		4				
Approved cable		Copper				
Conductor cross section						
• Inputs per pole	- Solid/stranded conductor acc. to IEC	mm ²	1 x 2.5 ... 16	1 x 6 ... 35	1 x 10 ... 35	
		Neutral conductor	mm ²	--	1 x 6 ... 35	--
- Flexible wire with sleeve connector	Neutral conductor	mm ²	1 x 2.5 ... 10	1 x 6 ... 25	1 x 10 ... 25	
		mm ²	--	1 x 6 ... 25	--	
• Outputs per pole	- Solid/stranded conductor acc. to IEC	Large	mm ²	8 x 1.5 ... 10	2 x 4 ... 16	3 x 6 ... 25
		Neutral conductor	Small	mm ²	--	5 x 1.5 ... 6
- Flexible wire with sleeve connector	Neutral conductor	Large	mm ²	--	6 x 4 ... 16	--
		Small	mm ²	--	4 x 1.5 ... 10	--
		Large	mm ²	8 x 1.5 ... 10	2 x 4 ... 10	3 x 6 ... 16
		Small	mm ²	--	5 x 1.5 ... 6	8 x 2.5 ... 10
Neutral conductor	Large	mm ²	--	6 x 4 ... 10	--	
	Small	mm ²	--	4 x 1.5 ... 6	--	
Tightening torque						
• Inputs	Plug-in connection	lb/in	13.5	13.5	3.5 ... 5	
		Nm	1.5	1.5	2	
• Outputs	Large	lb/in	13.5	13.5	13.5	
		Nm	1.5	1.5	1.5	
	Plug-in connection	Small	lb/in	--	7.2	13.5
		Nm	--	--	0.8	1.5
Plug-in connection		--	--	PZ1	PZ2	
Operational voltage						
• IEC, max.	V	690	690	1000 V AC 1500 V DC		
Overcurrent protection						
• Max. rated current	A	80	125	175		
• Rated peak withstand current (I_{pk})	kA	21.6	24	20		
• Rated short-time withstand current (I_{cw} 1 s)	kA	3	4.2	6.2		
Block dimensions (D x H x W)	mm	88 x 49 x 85	75 x 45 x 98	102 x 47 x 87		

Miniature Circuit Breakers

Busbars

5ST2 distribution blocks

UL types

			5ST2504	5ST2505	5ST2507	5ST2508	5ST2511
Standards, certifications			UL 1059 / UL 486E / IEC 60947-7-1 UL File No. E80027 / XCFR2 C22.2 No. 158 -1987 / XCFR8			UL 1059 / UL 486E / IEC 60947-7-1 UL File No. E80027 / XCFR2	
Degree of protection			IP 20				
Poles			1				
Approved cable			Copper				
Wiring type			Factory and field wiring				
• Front/back			Pressure wire connector				
Conductor cross section							
• Inputs							
- Solid and stranded conductor acc. to UL	Large	AWG	1 x 14 ... 4	1 x 8 ... 2	1 x 8 ... 2 / 0	1 x 2 ... 4 / 0	1 x 3 / 0 ... 350 MCM
- Solid and stranded acc. to IEC		mm ²	2.5 ... 16	10 ... 35	10 ... 70	35 ... 120	95 ... 185
- Solid and stranded conductor acc. to UL	Small	AWG	--	1 x 14 ... 6	--	--	--
- Solid and stranded acc. to IEC		mm ²	--	6 ... 16	--	--	--
- Finely stranded with end sleeve acc. to UL	Large	AWG	1 x 14 ... 4	1 x 8 ... 2	1 x 8 ... 1	1 x 2 ... 3 / 0	3 / 0 ... 5 / 0
- Finely stranded with end sleeve acc. to IEC		mm ²	2.5 ... 16	10 ... 35	10 ... 50	35 ... 95	95 ... 150
- Finely stranded with end sleeve acc. to UL	Small	AWG	--	1 x 14 ... 6	--	--	--
- Finely stranded with end sleeve acc. to IEC		mm ²	--	6 ... 16	--	--	--
• Outputs							
- Solid and stranded conductor acc. to UL	Top	AWG	4 x 14 ... 10	6 x 14 ... 6	6 x 14 ... 6	4 x 16 ... 8	--
- Solid and stranded acc. to IEC		mm ²	2.5 ... 6	2.5 ... 16	2.5 ... 16	1.5 ... 10	--
- Solid and stranded conductor acc. to UL	Medium	AWG	--	--	--	5 x 16 ... 6	--
- Solid and stranded acc. to IEC		mm ²	--	--	--	1.5 ... 16	--
- Solid and stranded conductor acc. to UL	Bottom	AWG	2 x 14 ... 6	--	--	2 x 14 ... 2	--
- Solid and stranded acc. to IEC		mm ²	2.5 ... 16	--	--	2 x 2.5 ... 35	--
- Finely stranded with end sleeve acc. to UL	Top	AWG	4 x 14 ... 10	6 x 14 ... 6	6 x 14 ... 6	2 x 14 ... 4	--
- Finely stranded with end sleeve acc. to IEC		mm ²	2.5 ... 6	2.5 ... 16	2.5 ... 16	2 x 2.5 ... 25	--
- Finely stranded with end sleeve acc. to UL	Bottom	AWG	2 x 14 ... 6	--	--	2 x 14 ... 4	--
- Finely stranded with end sleeve acc. to IEC		mm ²	2.5 ... 16	--	--	2 x 2.5 ... 25	--
Tightening torque							
• Inputs							
		lb/in	13.2 ... 26.5	31 ... 44	44 ... 53	170 ... 186	222
		Nm	1.5 ... 3	3.5 ... 5	5 ... 6	19 ... 21	25
	Plug-in connection			Allen key (4 mm)	Allen key (5 mm)	Allen key (6 mm)	Allen key (8 mm)
• Outputs							
	Large	lb/in	13.2 ... 26.5	17.7 ... 26.5	13.2 ... 26.5	31 ... 62	3.5 ... 7
		Nm	1.5 ... 3	2 ... 3	1.5 ... 3	3.5 ... 7	3.5 ... 7
	Plug-in connection		PZ2			Standard screwdriver	
	Small	lb/in	7 ... 13.2	--	--	18 ... 27	--
		Nm	0.8 ... 1.5	--	--	2 ... 3	--
	Plug-in connection		PZ1	--	--	Standard screwdriver	--
Amperes per pole, max. (UL/IEC)	A		80/80	115/125	160/160	230/250	310/400
Operational voltage							
• UL, max. (AC)	V		600				
• IEC, max. (AC/DC)	V		1000/1500				
Overcurrent protection							
• Required class			J				
• Max. rated current (UL/IEC)	A		80/80	115/125	160/160	230/250	310/400
• SCCR RMS Sym A	kA		100				
• Rated peak withstand current (I_{pk})	kA		2.7	30		51	
• Rated short-time withstand current (I_{cw} 1 s)	kA		1.9	4.2	11	21	
Clearance							
• Air		inches (mm)	3 / 8 (9.5)				
• Creepage distance		inches (mm)	1 / 2 (12.7)				
Fire class			UL 94V-0				
Block dimensions (D x H x W)	mm		66 x 47 x 27	74 x 47 x 27	92 x 49 x 35	96 x 49 x 45	96 x 49 x 45
Connections			With cable up to 16 mm ²	With connector or cable up to 16 mm ² ¹⁾	Lateral incoming feeder for parallel connection with copper bar (max. 16 x 5 mm)	--	--

¹⁾ Copper jumper is tested for a rated current of 100 A

Dimensional drawings

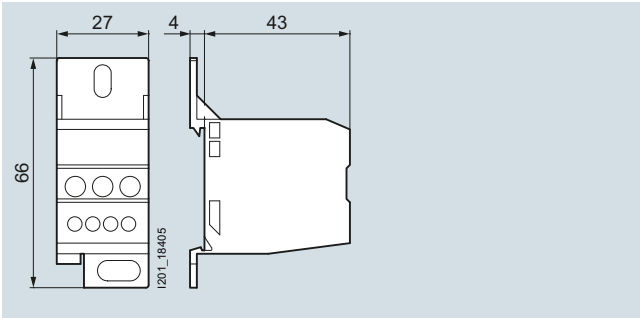

5ST2504

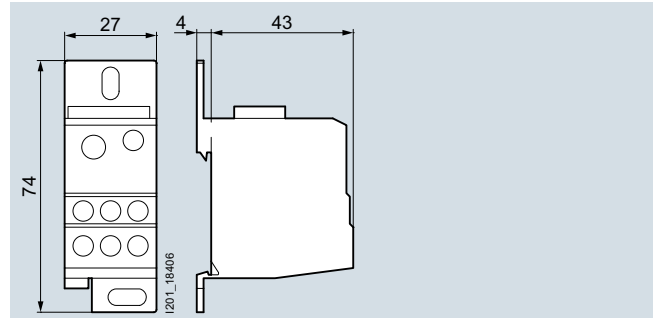

5ST2505

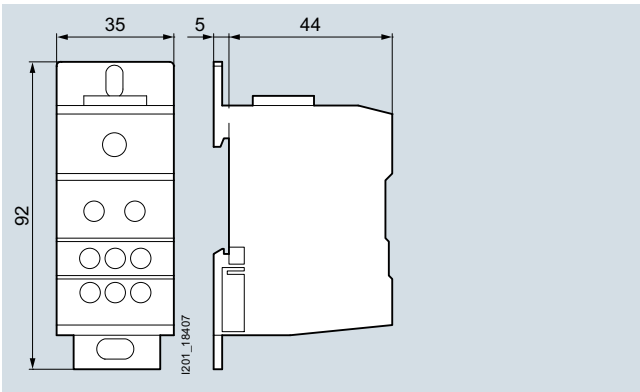

5ST2507

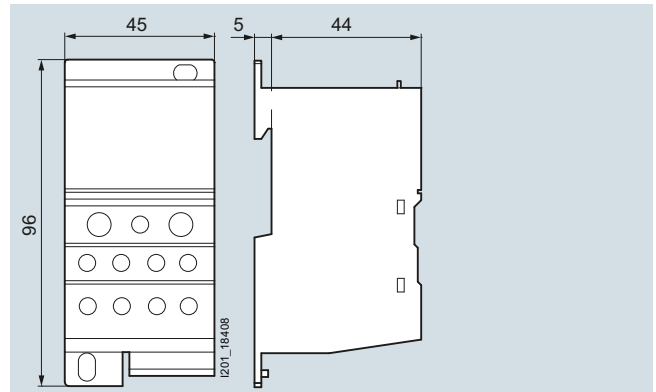

5ST2508

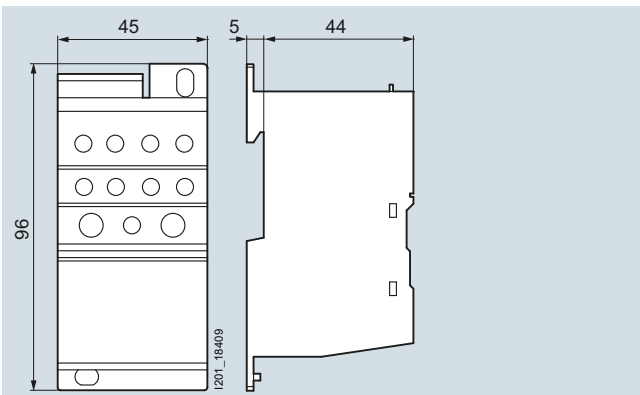

5ST2511

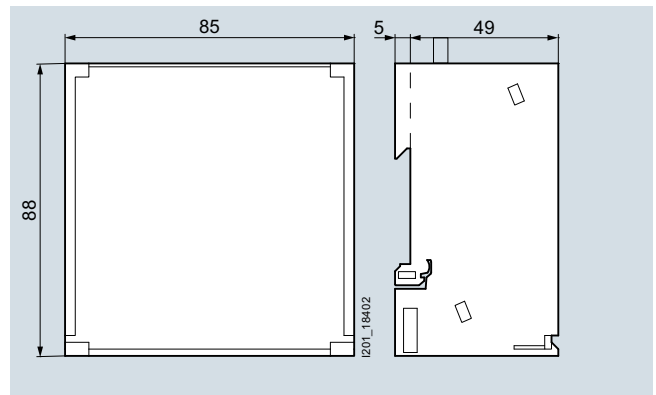

5ST2501

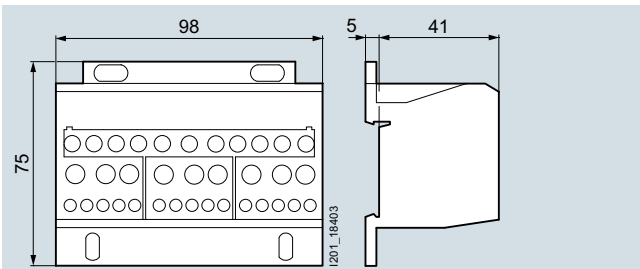

5ST2502

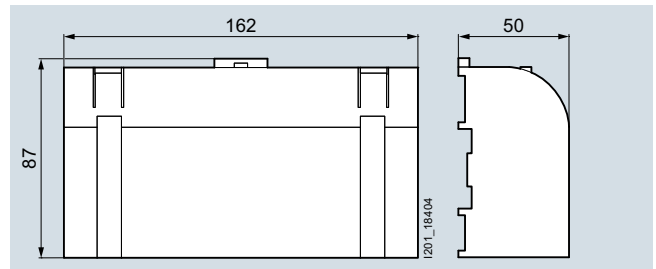

5ST2503

Miniature Circuit Breakers

Busbars

SIKclip wiring system

Overview

SIKclip is a fast wiring system that simplifies the connection of control switches:

- For mounting directly on the rear vertical CU busbar system
- Mounting via brackets on the rear of the DIN rail

The 4-pole busbar can handle loads of up to 250 A, each individual contact up to 63 A.

High degree of protection because each contact is locked individually.

SIKclip is made of thermoplastic acc. to IEC 60439-3 and is suitable for high thermal loads.

Note:

To install the SIKclip wiring system in the ALPHA AS, the busbars must be installed in a vertical rear position, but not recessed. If the busbars are in a recessed position the cables will not reach the circuit breakers.

Technical specifications

		5ST25..
Compliance to standards		EN 60947-1, EN 61439-1
Degree of protection		IP20
Max. rated current I_n	A	250 at 40 °C ambient temperature
Max. rated output current I_n	A	63 A at 40 °C ambient temperature
Rated operational voltage U_n	V AC	400
Rated insulation voltage	V AC	660
Test voltage	kV	2.5, 50 Hz
Connecting cables		40 A (6 mm ²), 63 A (10 mm ²)
Connecting cable type		H07VK
Ambient temperature	°C	-5 ... +60

Dimensional drawings

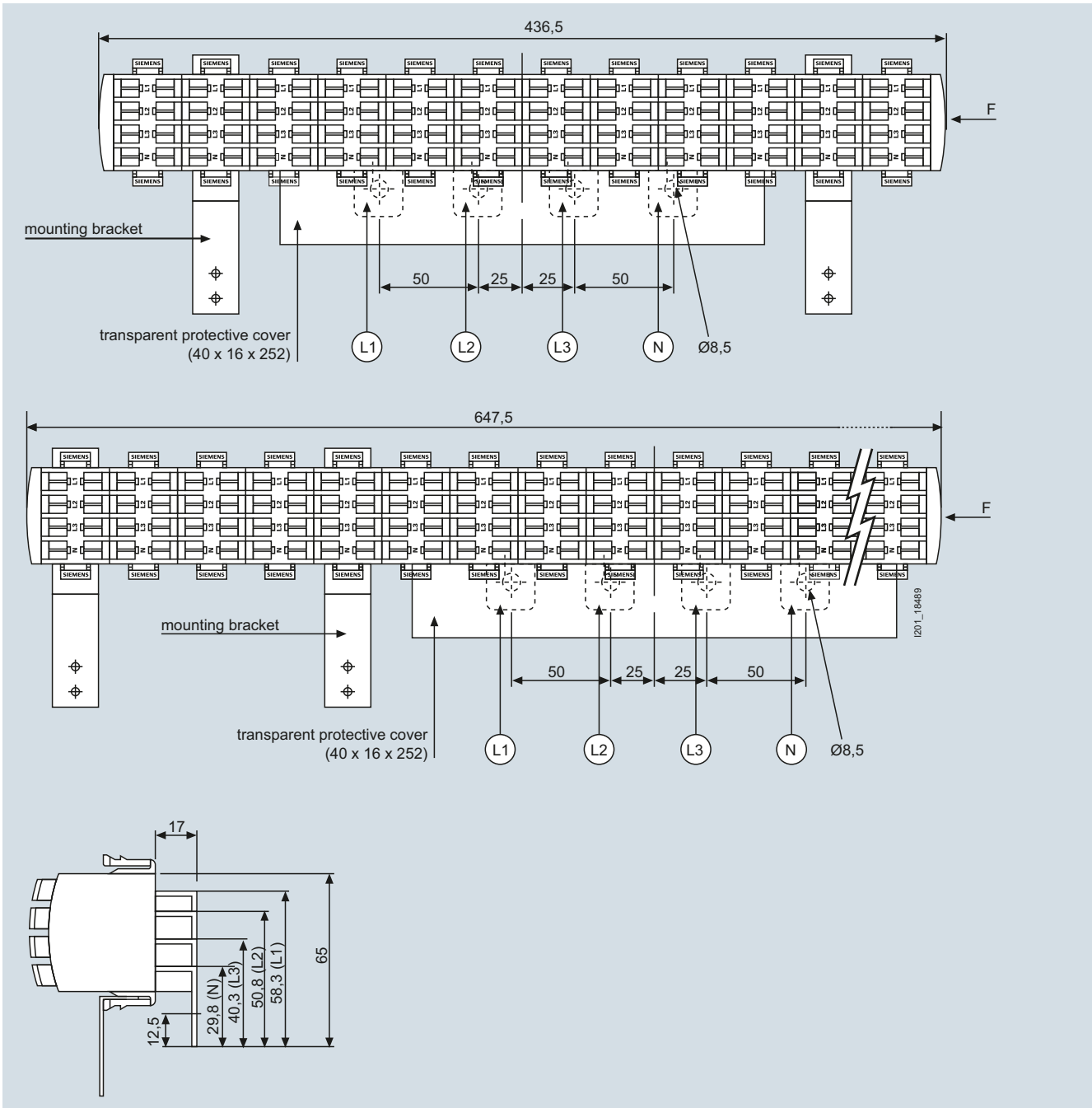

Miniature Circuit Breakers

Configuration and dimensioning

Overview

Breaking capacity

Particular demands are made on miniature circuit breakers with regard to breaking capacity.

The values are standardized and are determined according to the test conditions of IEC/EN 60898-1/-2 or DIN VDE 0641-11.

The values of the rated breaking capacity I_{cn} are , and .

For other test conditions, it is also possible to specify values higher than those stipulated in IEC/EN 60898-1/-2 or DIN VDE 0641-11.

One such standard is IEC/EN 60947-2 or DIN VDE 0660-101 for circuit breakers.

5SL3, 5SL4, 5SL6, 5SY6, 5SY4, 5SY7, 5SY8, 5SY60 and 5SP4 miniature circuit breakers

	I_n [A]	IEC/EN 60898-1	2-, 3-, 4-pole, 3-pole+N	IEC/EN 60947-2	2-, 3-, 4-pole, 3-pole+N
		1-pole, 1-pole+N 230 V AC	AC 400 V	1-pole, 1-pole+N 230 V AC	AC 400 V
		I_{cn} [kA]	I_{cn} [kA]	I_{cu} [kA]	I_{cu} [kA]
5SL3	0.3 ... 63	4.5		--	
5SL4	0.3 ... 63	10		10	
5SL6	0.3 ... 63	6		6	
5SY6 (without 5SY60)	0.3 ... 6	6		30	
	8 ... 32	6		15	
	40 ... 63	6		10	
5SY4	0.3 ... 6	10		35	
	8 ... 32	10		20	
	40 ... 63	10		15	
	80	10		10	
5SY7	0.3 ... 2	15		50	
	3 ... 6	15		40	
	8 ... 10	15		30	
	13 ... 32	15		25	
	40 ... 63	15		20 ¹⁾	
5SY8	0.3 ... 2	--		70	
	3 ... 6	--		50	
	8 ... 10	--		40	
	13 ... 32	--		30	
	40 ... 63	--		25 ²⁾	
5SY30..	2 ... 40	4.5		--	--
5SY60..	2 ... 40	6	--	6	--
5SP4	80 ... 125	10		10	

¹⁾ D50 and D63: $I_{cu} = 15$ kA.

²⁾ D50 and D63: $I_{cu} = 20$ kA.

5SY5 miniature circuit breakers

Miniature circuit breakers, universal current	I_n [A]	IEC/EN 60898-2	2-pole	IEC/EN 60898-2	2-pole
		1-pole 230/400 V AC	AC 400 V	1-pole 220 V DC	440 V DC
		I_{cn} [kA]	I_{cn} [kA]	I_{cn} [kA]	I_{cn} [kA]
5SY5	0.3 ... 63	10		10	

5SY30.. and 5SY60.. miniature circuit breakers.

Rated making and breaking capacity I_{cn1}	I_n [A]	IEC/EN 60898-1
		1-pole + N 230 V AC
		I_{cn1} [kA]
5SY30..	2 ... 16	4.5
	20 ... 40	3
5SY60..	2 ... 4	6
	6 ... 16	4.5

Characteristic curves

Tripping characteristics acc. to IEC/EN 60898-1, DIN VDE 0641-11

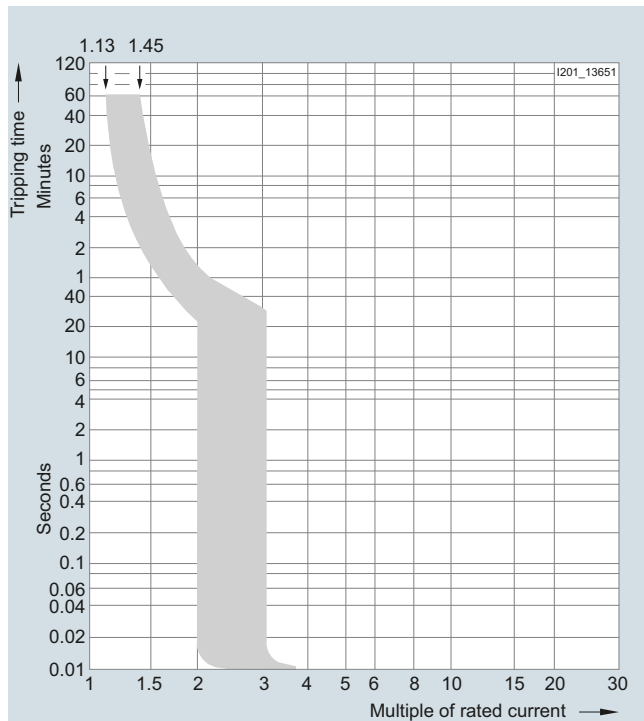

Tripping characteristic A

For limited semiconductor protection, protection of measuring circuits with transformers. Protection of circuits with tripping in 0.4 s acc. to DIN VDE 0100-410, for long cable lengths.

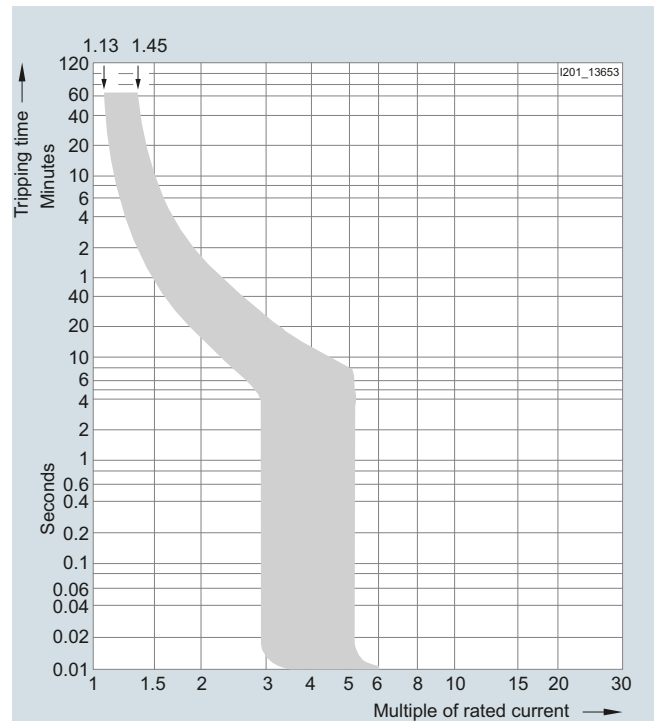

Tripping characteristic B

MCBs with this tripping characteristic are designed for universal use in socket outlet and lighting circuits. Proof of personal safety acc. to DIN VDE 0100-410 is not required.

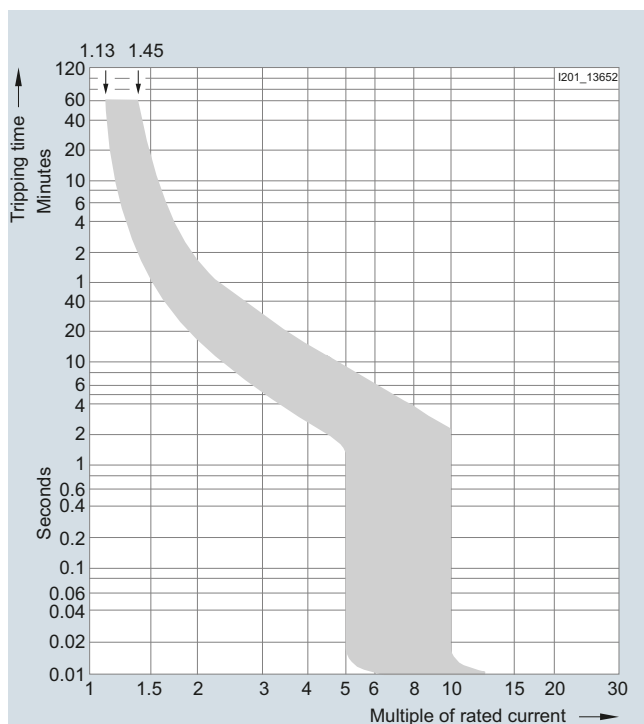

Tripping characteristic C

In lamp and motor circuits with higher starting currents, MCBs with tripping characteristic C are generally used.

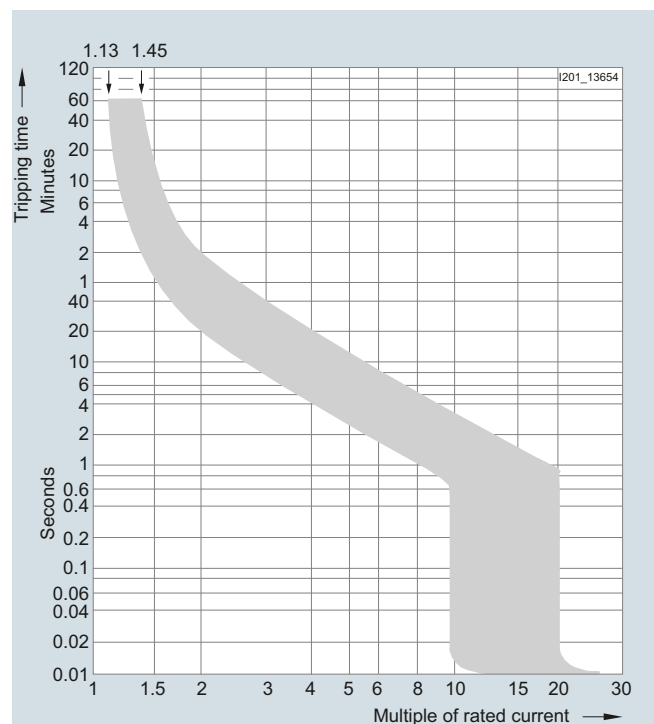

Tripping characteristic D

For electrical circuits with strong pulse-generating equipment, such as transformers or solenoid valves.

Miniature Circuit Breakers

Configuration and dimensioning

Tripping characteristics

Tripping behaviour at 30 °C ambient temperature

Tripping characteristic	Standards	Thermal release Test currents:				Electromagnetic release Test currents:		
		Small test current I_1	Large test current I_2	Tripping time		Hold I_4	Latest tripping I_5	Tripping time t
				$I_n \leq 63$ A	$I_n > 63$ A			
A	--	$1.13 \times I_n$	$1.45 \times I_n$	> 1 h < 1	> 2 h < 2	$2 \times I_n$	$3 \times I_n$	≥ 0.1 s < 0.1 s
B	IEC/EN 60898-1, DIN VDE 0641-11	$1.13 \times I_n$	$1.45 \times I_n$	> 1 h < 1	> 2 h < 2	$3 \times I_n$	$5 \times I_n$	≥ 0.1 s < 0.1 s
C	IEC/EN 60898-1, DIN VDE 0641-11	$1.13 \times I_n$	$1.45 \times I_n$	> 1 h < 1	> 2 h < 2	$5 \times I_n$	$10 \times I_n$	≥ 0.1 s < 0.1 s
D	IEC/EN 60898-1, DIN VDE 0641-11	$1.13 \times I_n$	$1.45 \times I_n$	> 1 h < 1	> 2 h < 2	$10 \times I_n$	$20 \times I_n$ (IEC 60898: $50 \times I_n$)	≥ 0.1 s < 0.1 s

Correction factors for the rated current at different ambient temperatures for 5SL3...- and 5SL6...-

Dependence of the permissible continuous load current on the ambient temperature for 5SL3...- and 5SL6...- miniature circuit breakers

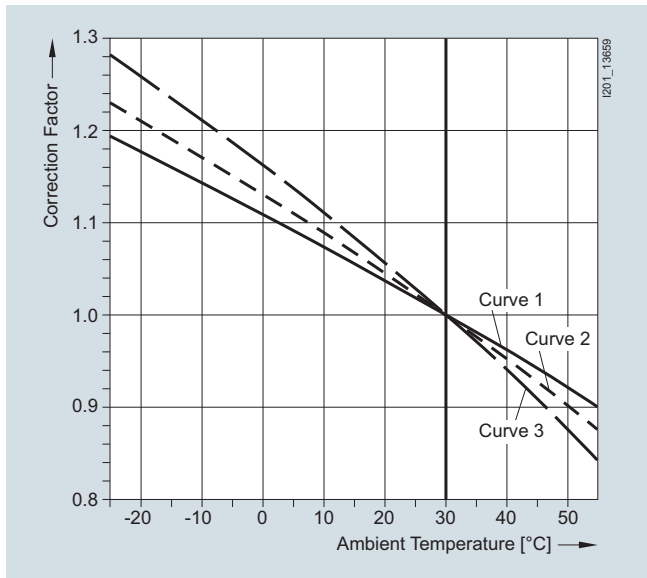

Correction factors for the rated current at different ambient temperatures for 5SL4...-

Dependence of the permissible continuous load current on the ambient temperature for 5SL4...- miniature circuit breakers

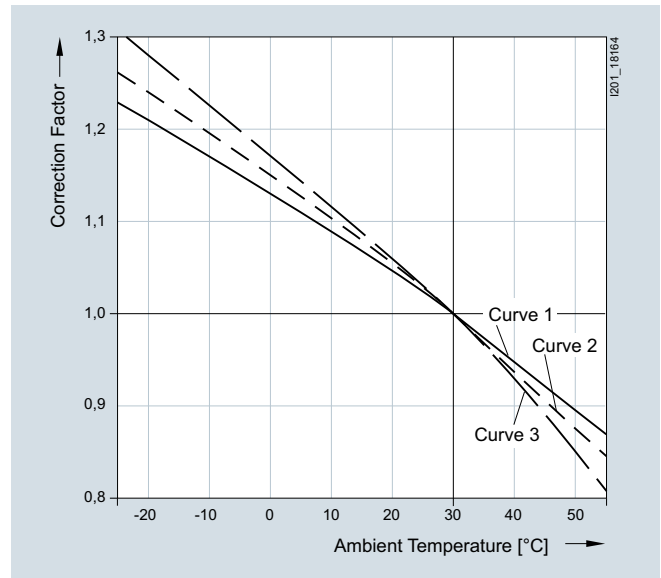

The valid curve for the correction factor can be found in the following table.

Curve for correction factor for 5SL3...- and 5SL6...- miniature circuit breakers (for curves, see diagram above)

Rated current (A)	0.3	0.5	1	1.6	2	3	4	6	8	10	13	16	20	25	32	40	50	63	
Characteristic	Valid curve for the correction factor for 5SL miniature circuit breakers																		
B	Pole type																		
1P/2P	--	--	--	--	--	--	--	3	--	2	2	2	3	3	3	3	3	3	
3P/4P	--	--	--	--	--	--	--	3	--	2	2	2	3	2	1	2	3	3	
C	Pole type																		
1P/2P	3	3	2	2	2	3	3	3	2	3	2	2	3	3	3	3	3	3	
3P/4P	2	2	2	1	2	2	2	3	2	3	2	2	3	2	3	2	3	3	

Correction factors for the rated current at different ambient temperatures for 5SY

Dependence of the permissible continuous load current on the ambient temperature for 5SY miniature circuit breakers (without 5SY60..)

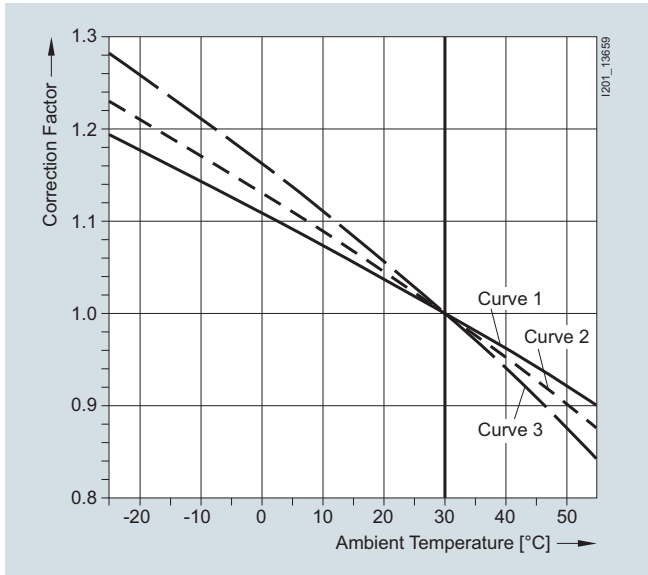

The valid curve for the correction factor can be found in the following table.

Curve for correction factor for 5SY miniature circuit breakers (for curves, see left-hand diagram above)

Rated current (A)		0.3	0.5	1	1.6	2	3	4	6	8	10	13	16	20	25	32	40	50	63	80
Valid curve for the correction factor for 5SY miniature circuit breakers																				
A	1P/2P	3	3	2	2	2	3	3	3	2	3	2	2	3	2	2	3	2	3	--
	3P/4P	2	2	2	1	2	2	2	2	2	2	1	1	2	1	1	1	1	2	--
B	1P/2P	--	--	--	--	--	--	--	3	--	3	2	2	3	3	2	3	2	3	2
	3P/4P	--	--	--	--	--	--	--	2	--	2	1	2	2	1	1	1	1	2	1
C	1P/2P	3	3	2	2	2	3	3	3	3	3	2	3	3	2	2	3	2	3	2
	3P/4P	2	2	2	1	2	2	2	2	3	3	2	2	2	2	1	1	1	2	1
D	1P/2P	3	3	2	2	2	3	3	3	3	3	2	3	3	2	2	3	2	3	--
	3P/4P	2	2	2	1	2	2	2	2	3	3	2	2	2	2	2	2	1	2	--

Curve for correction factor for 5SY60.. miniature circuit breakers (for curves, see right-hand diagram above)

Rated current (A)		2	4	6	8	10	13	16	20	25	32	40
Valid curve for the correction factor for 5SY60.. miniature circuit breakers												
B		--	--	1	--	2	2	2	2	1	2	2
C		--	--	1	3	2	2	3	3	1	2	2

Dependence of the permissible continuous load current on the ambient temperature for 5SY60.. miniature circuit breakers

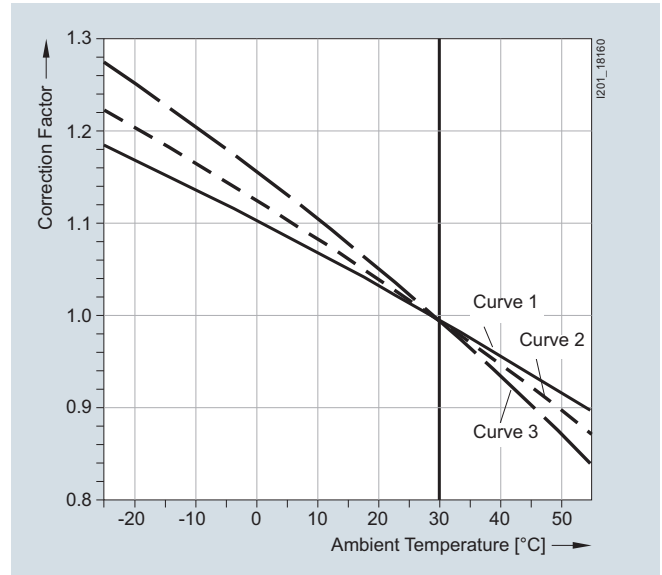

The valid curve for the correction factor can be found in the following table.

Miniature Circuit Breakers

Configuration and dimensioning

Correction factors for rated current if bundling

If more than one electrical circuit is loaded in a series of miniature circuit breakers the resulting increase in ambient temperature affects the characteristic curve. In this case an additional correction factor, specific to the rated current of the miniature circuit breaker, must be taken into account.

Number of MCBs	1	2 ... 3	4 ... 6	> 7
Correction factor K	1.00	0.90	0.88	0.85

Correction factors for rated current at different frequencies

The tripping characteristic applies to a frequency of 50 Hz to 60 Hz. In the case of other frequencies, the following correction factors must be taken into account.

In the overrange, the limits of the characteristic curves correspond to the correction factors of the thermal tripping operation. In the event of a short-circuit, the limits of the characteristic curves correspond to the correction factors of the magnetic tripping operation.

Correction factors for rated breaking capacities I_{cn} dependent on altitude above sea level of location

Altitude above sea level / m	Correction factor	I_{cn} / kA 5SY6	I_{cn} / kA 5SY4	I_{cn} / kA 5SY7	I_{cn} / kA 5SP4
500	1	6	10	15	10
1000	1	6	10	15	10
1500	1	6	10	15	10
2000	1	6	10	15	10
2500	0.94	5.6	9.4	14.1	9.4
3000	0.88	5.3	8.8	13.2	8.8
3500	0.83	5	8.3	12.4	8.3
4000	0.78	4.7	7.8	11.7	7.8

Thermal tripping operation

Rated current I_n (A)	Correction factor for					
	0 Hz	16 2/3 Hz	50/60 Hz	125 Hz	400 Hz	1000 Hz
5SL4...-	0.3 ... 6	1	1	1	1	1
	8 ... 20	1	1	1	1	0.99
	25 ... 40	1	1	1	1	0.99
	50 ... 63	1	1	1	0.99	0.96
5SY	0.3 ... 10	1	1	1	1	0.99
	1 ... 40	1	1	1	0.98	0.97
	50 ... 63	1	1	1	0.98	0.94
5SP	80 ... 125	1	1	1	0.97	0.92

Magnetic tripping operation

Rated current I_n (A)	Correction factor for					
	0 Hz	16 2/3 Hz	50/60 Hz	125 Hz	400 Hz	1000 Hz
5SL4...-	B1 ... B63	--	1.2	1	1.3	1.6
	C0.3 ... C63	--	1.2	1	1.2	1.5
	D0.3 ... D63	--	1.1	1	1.2	1.5
5SY	0.3 ... 63	1.4	1	1	1.2	1.4
5SP	80 ... 125	1.5	1	1	1.05	1.3

Dependence of the reduction factor on the ambient temperature for 5SP miniature circuit breakers

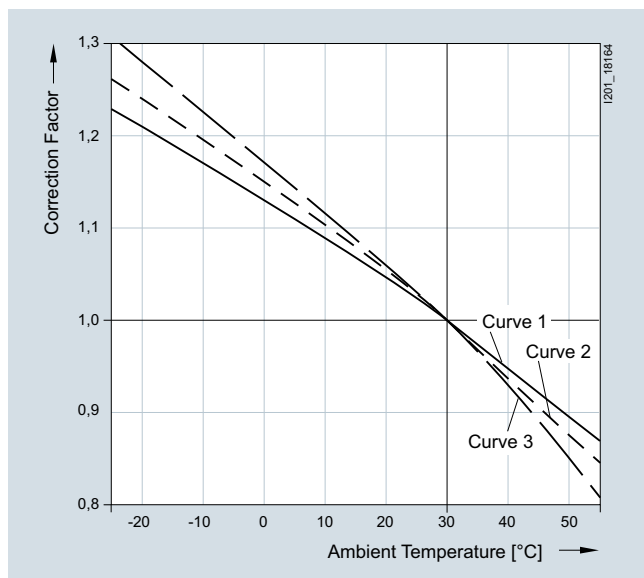

Curve for correction factor for 5SP4 miniature circuit breakers (for curves, see diagram on the left)

Rated current (A)	80	100	125
Characteristic			
C	1P	2	2
	2P/3P/4P	1	1
D	1P	3	--
	2P/3P/4P	1	--

Let-through current I_{max} 5SL3...-6

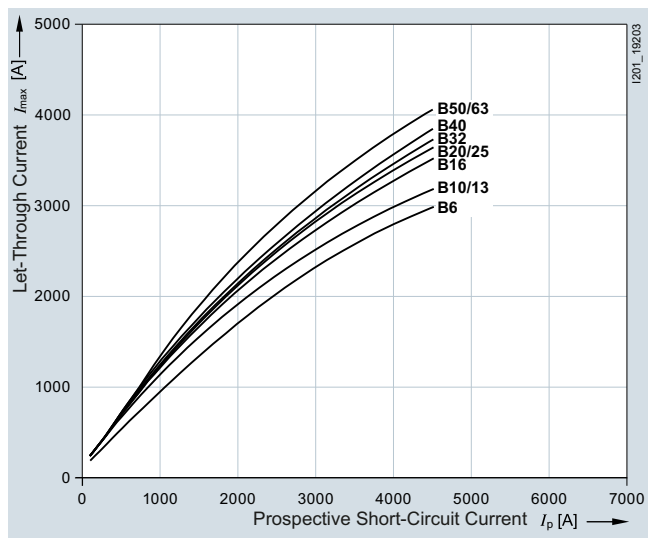

Let-through current I_{max} 5SL4...-6

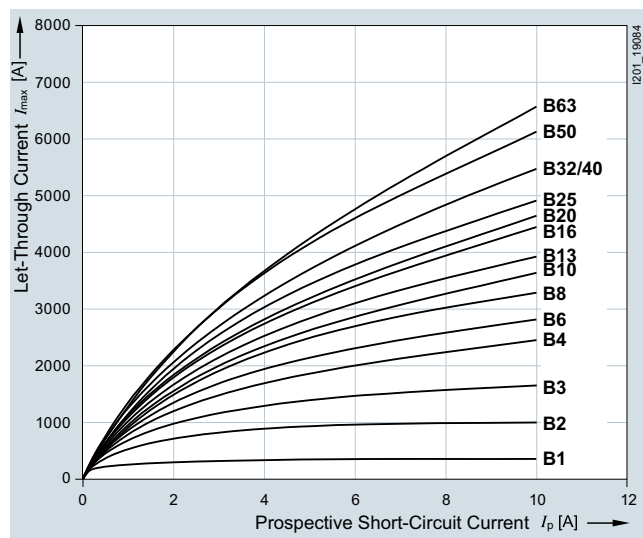

Let-through current I_{max} 5SL4...-7

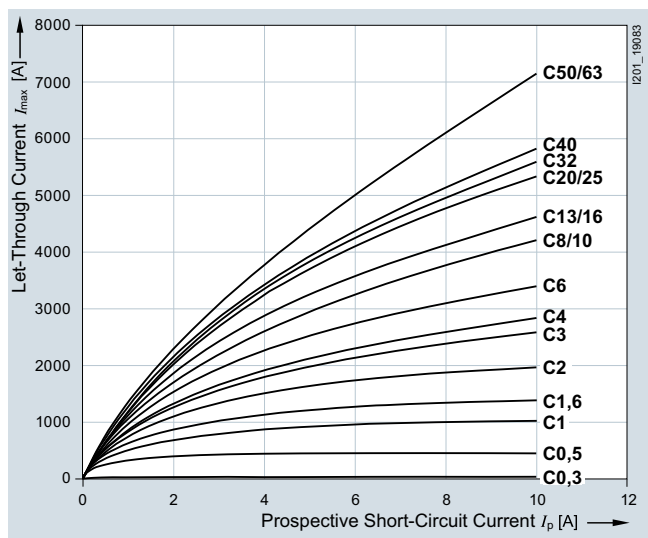

Let-through current I_{max} 5SL4...-8

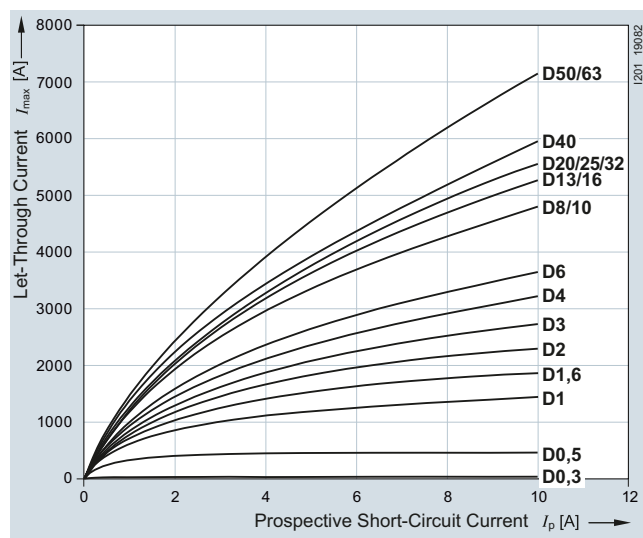

Let-through current I_{max} 5SL6...-6

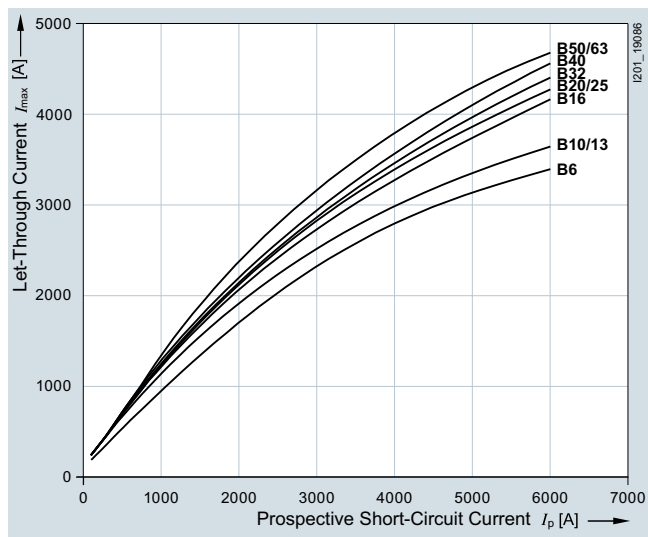

Let-through current I_{max} 5SL6...-7

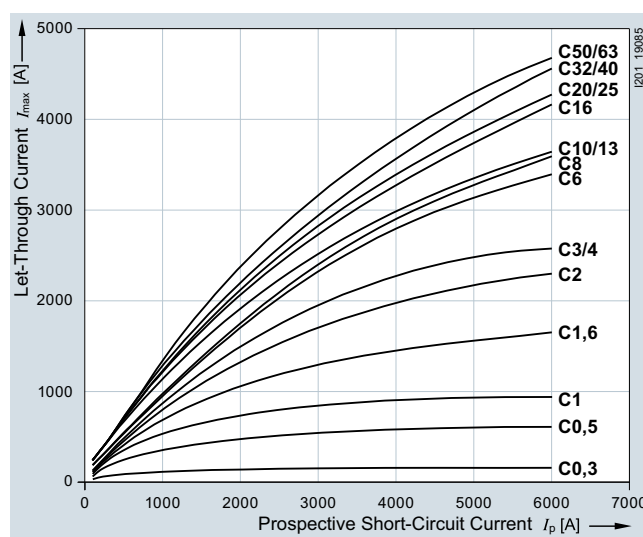

Miniature Circuit Breakers

Configuration and dimensioning

Let-through I^2t values 5SL3 (AC)

Characteristic B

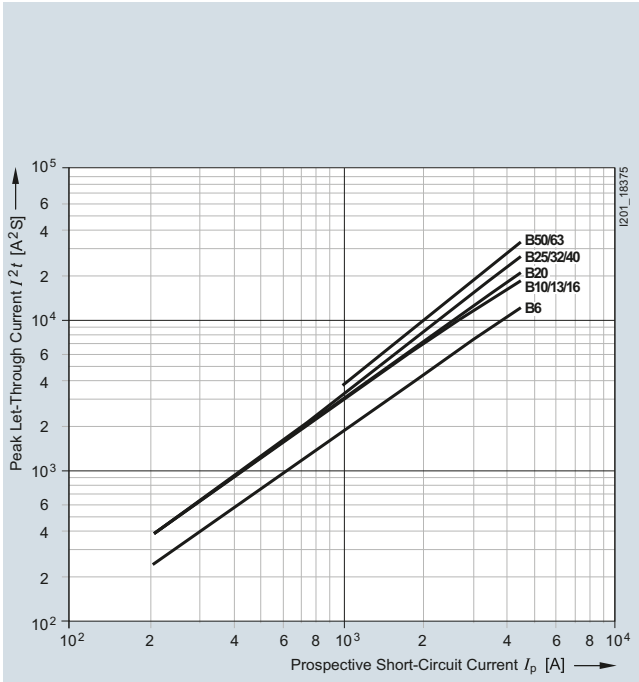

Characteristic C

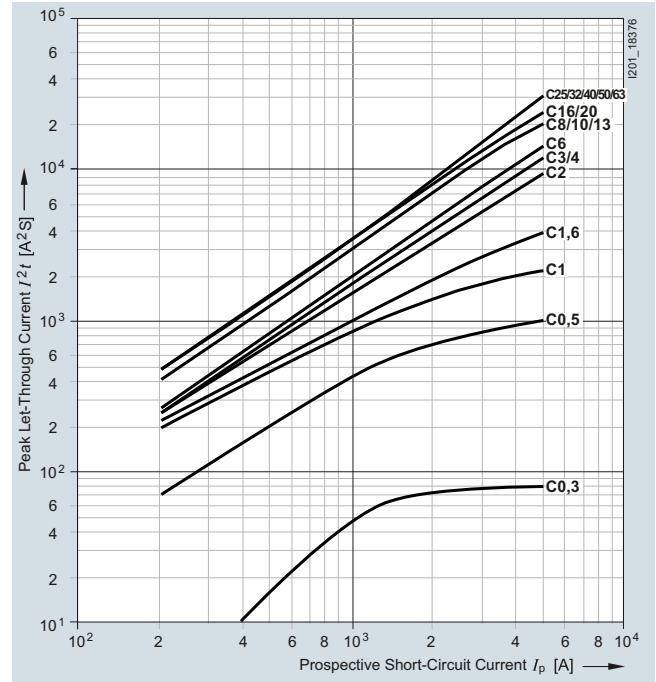

Let-through I^2t values 5SL4...-6 (AC)

Characteristic B

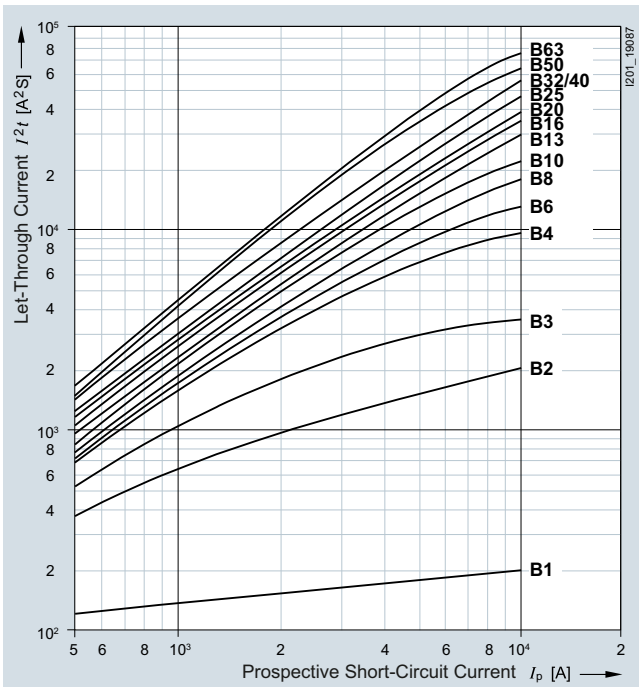

Let-through I^2t values 5SL4...-7 (AC)

Characteristic C

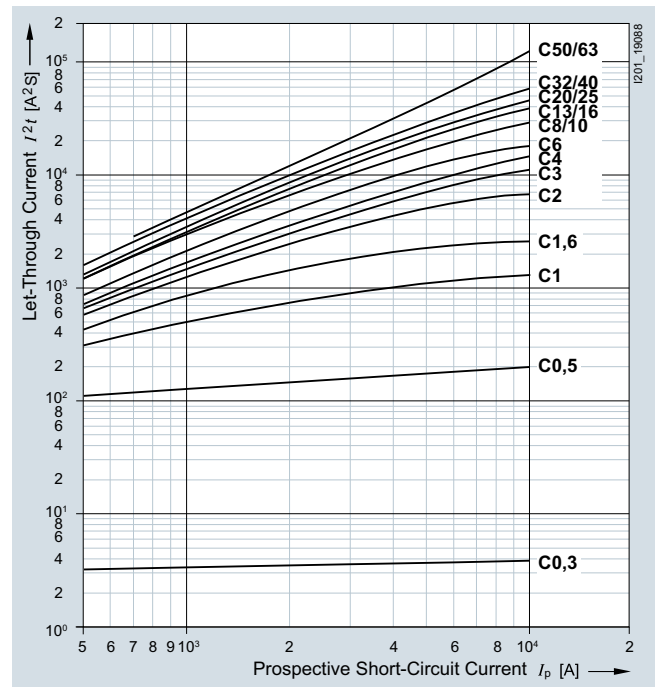

Let-through I^2t values 5SL4...-8 (AC)

Characteristic D

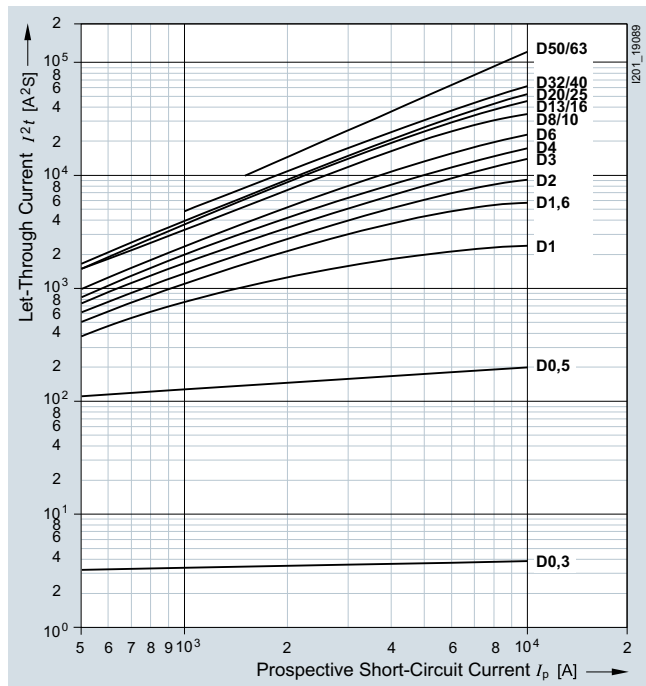

Let-through I^2t values 5SL6 (AC)

Characteristic B

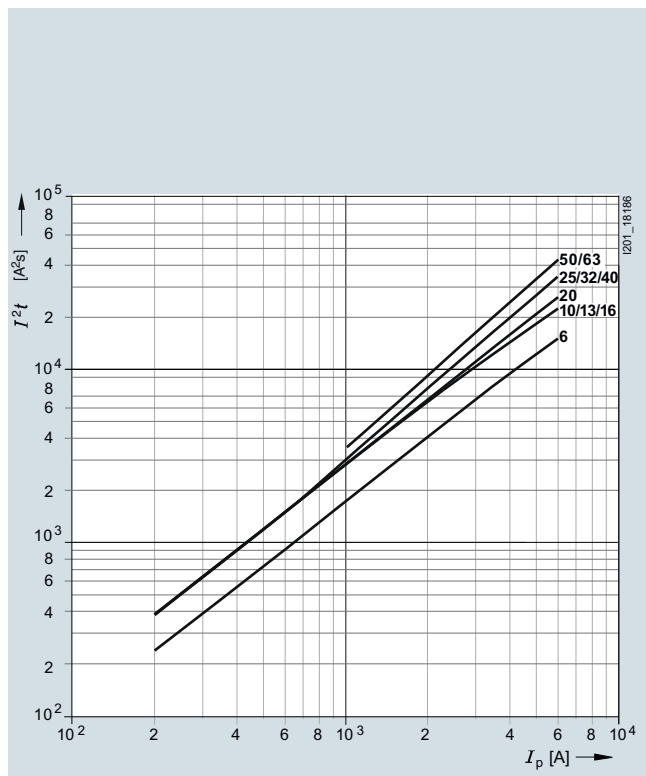

Characteristic C

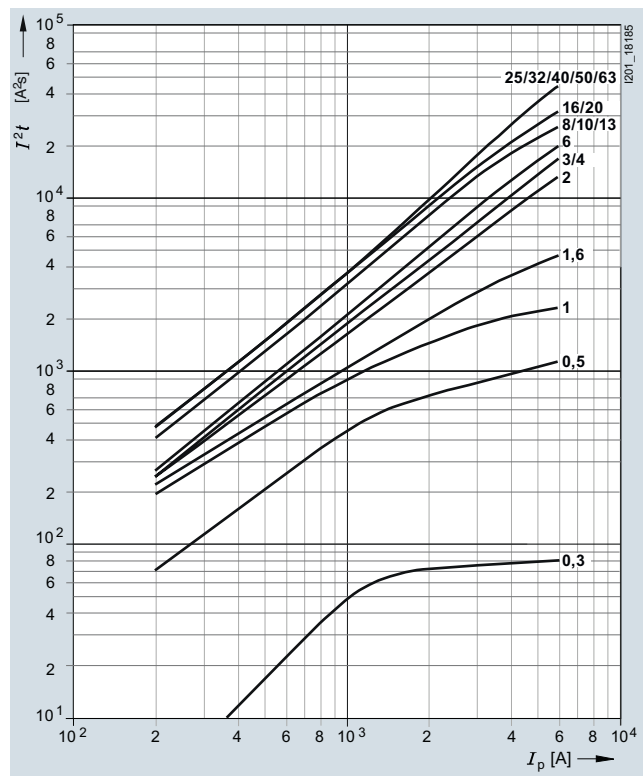

Miniature Circuit Breakers

Configuration and dimensioning

Let-through I^2t values 5SY6 (AC)

Characteristic B

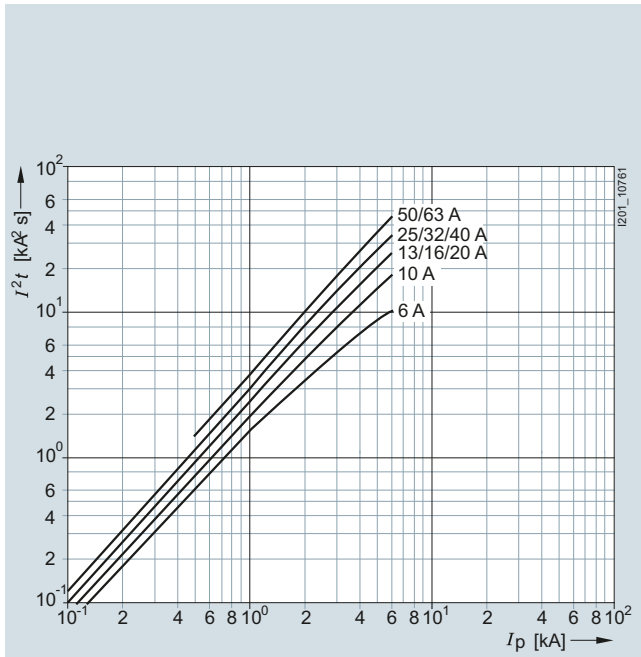

Characteristic C

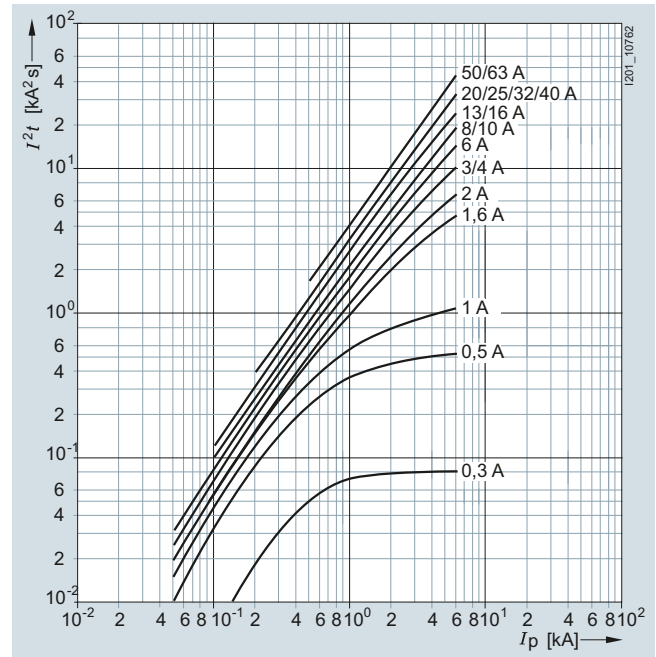

Let-through I^2t values 5SY4 (AC)

Characteristic A

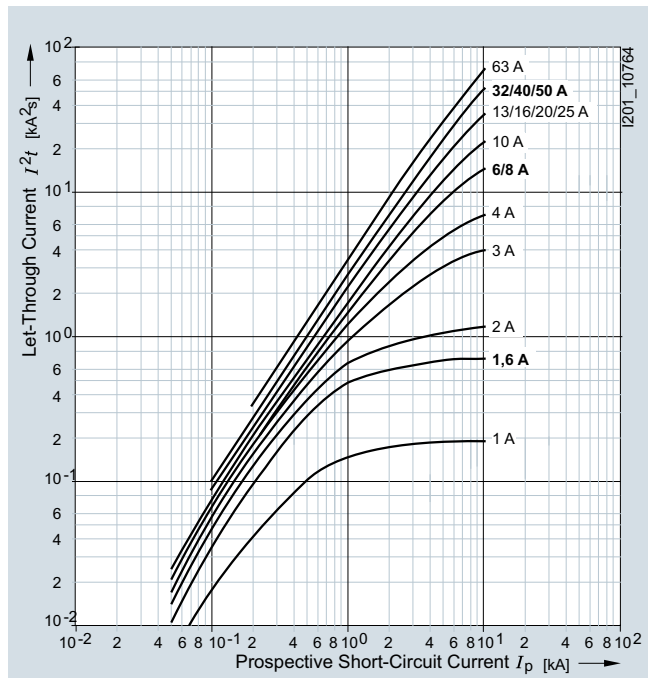

Characteristic B

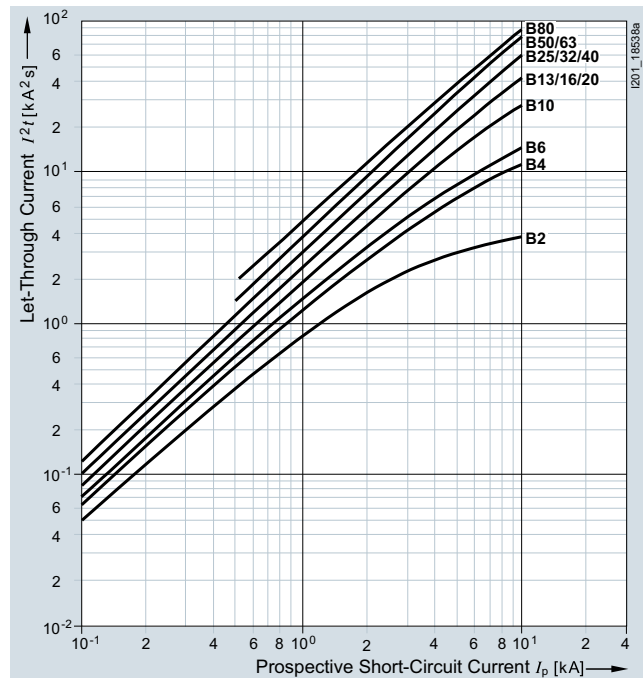

Characteristic C

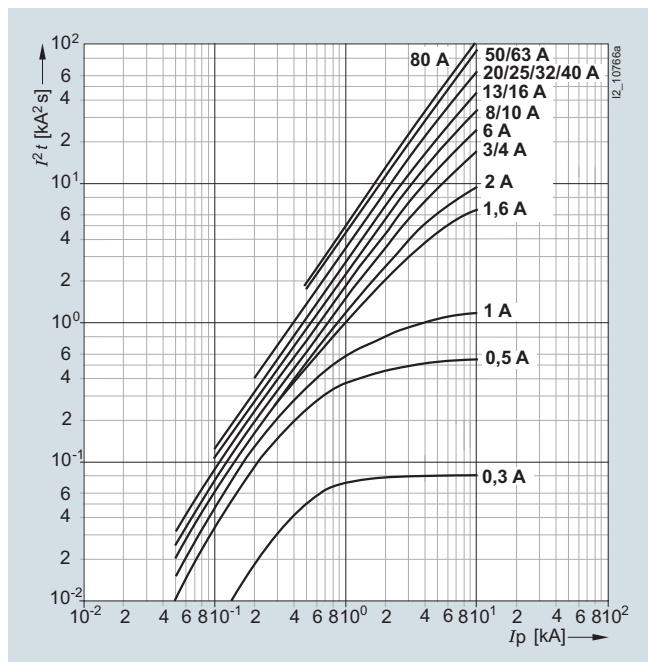

Characteristic D

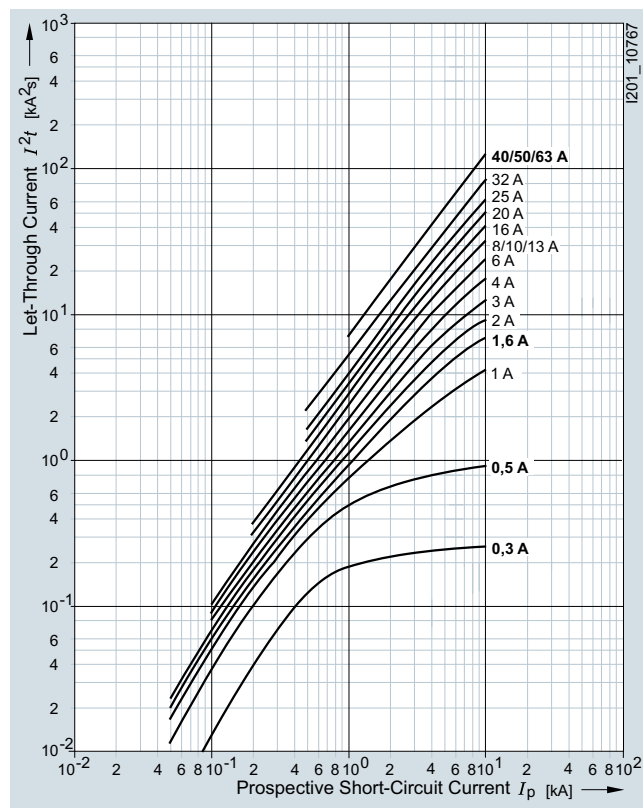

Miniature Circuit Breakers

Configuration and dimensioning

Let-through I^2t values 5SP4 (AC)

Characteristic B

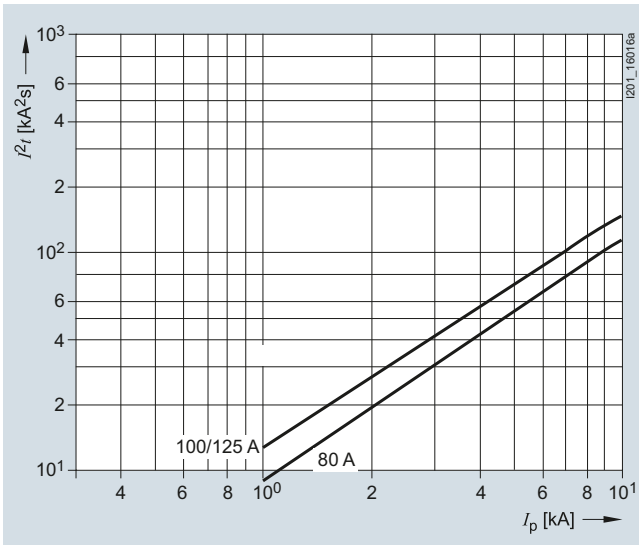

Characteristic C

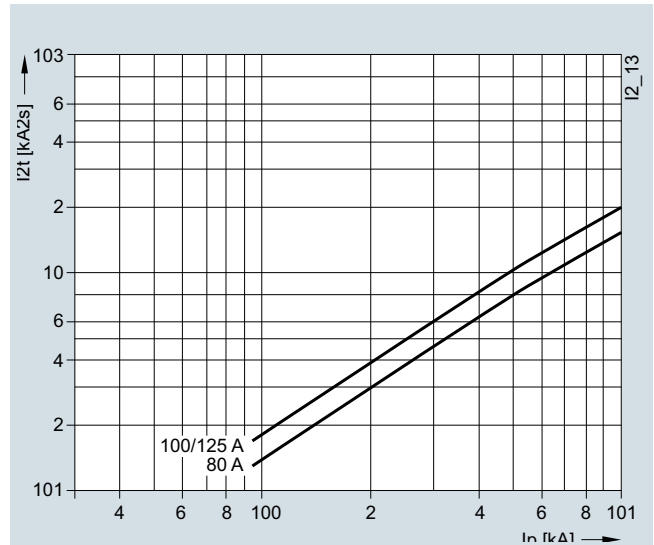

Characteristic D

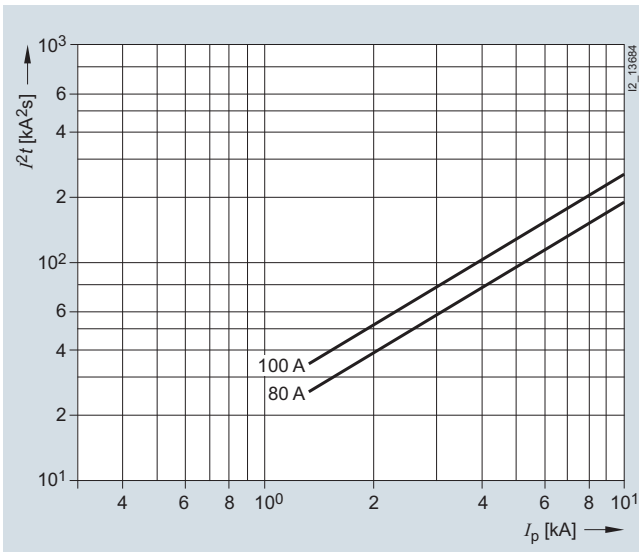

Let-through I^2t values 5SY5 (DC)

Characteristic B

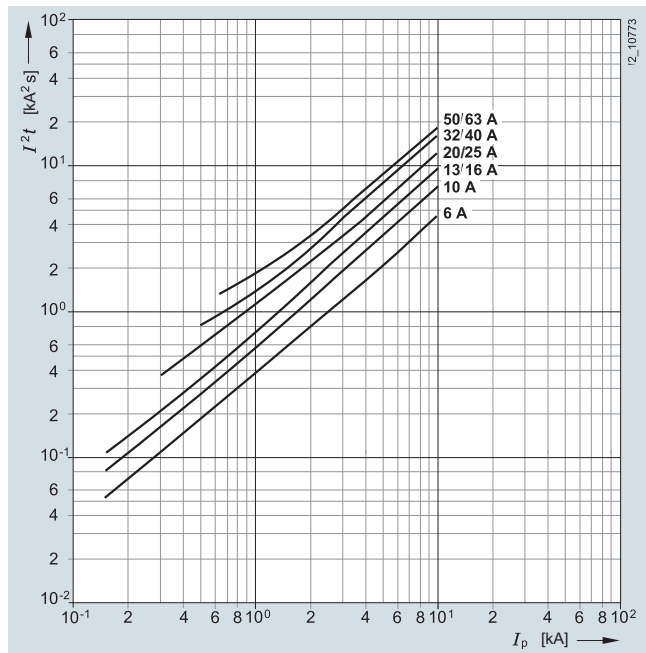

Characteristic C

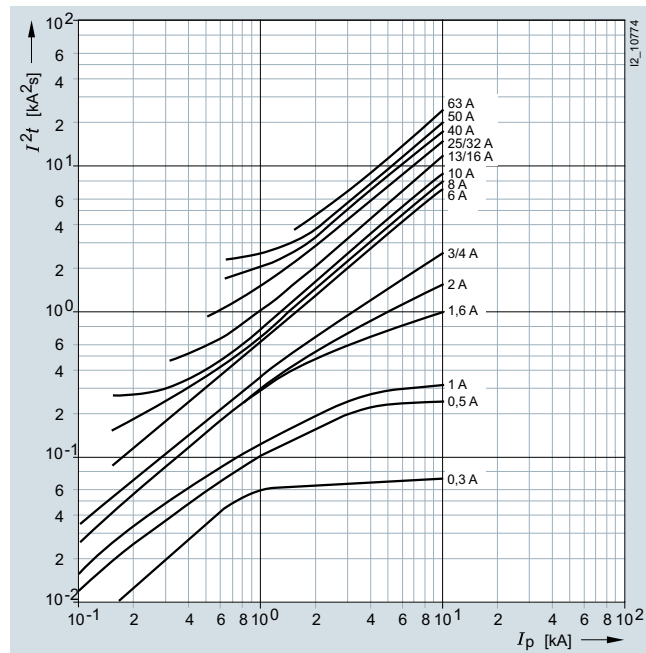

Let-through I^2t values 5SY8 (AC)

Characteristic C

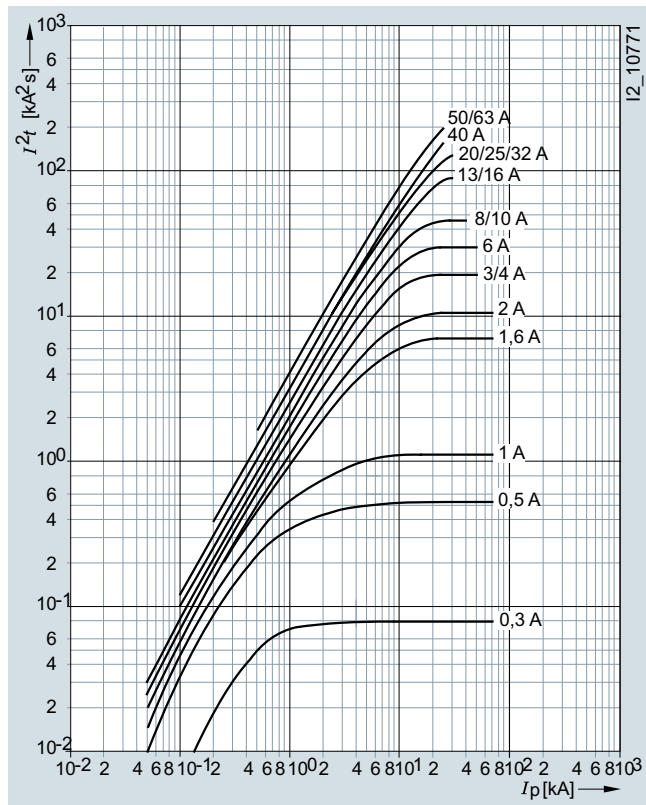

Characteristic D

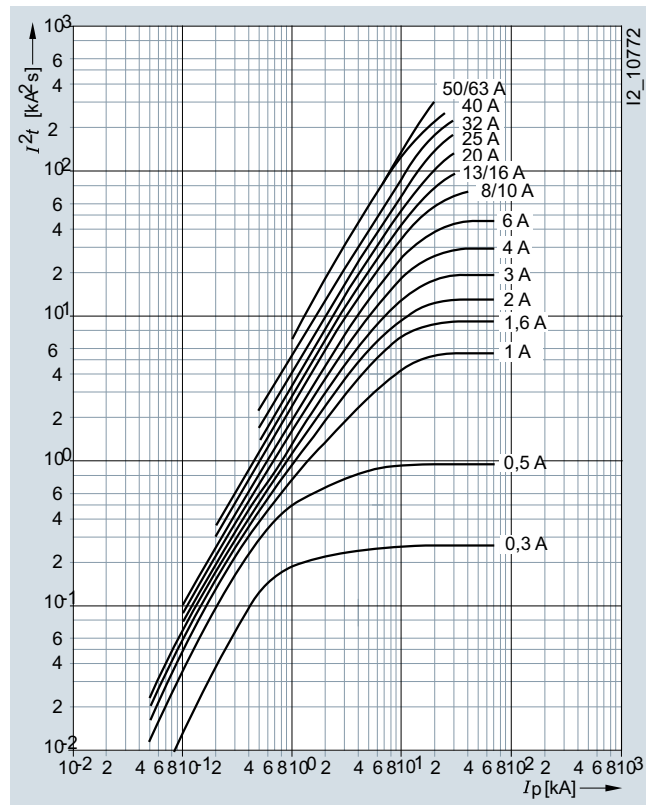

Miniature Circuit Breakers

Configuration and dimensioning

Let-through I^2t values 5SY7 (AC)

Characteristic B

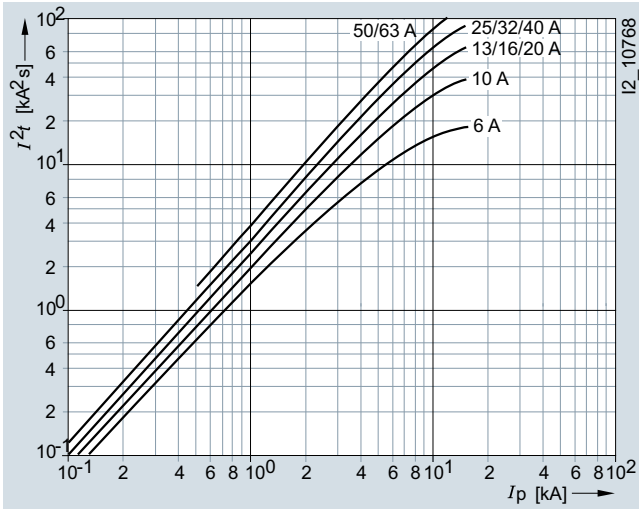

Characteristic D

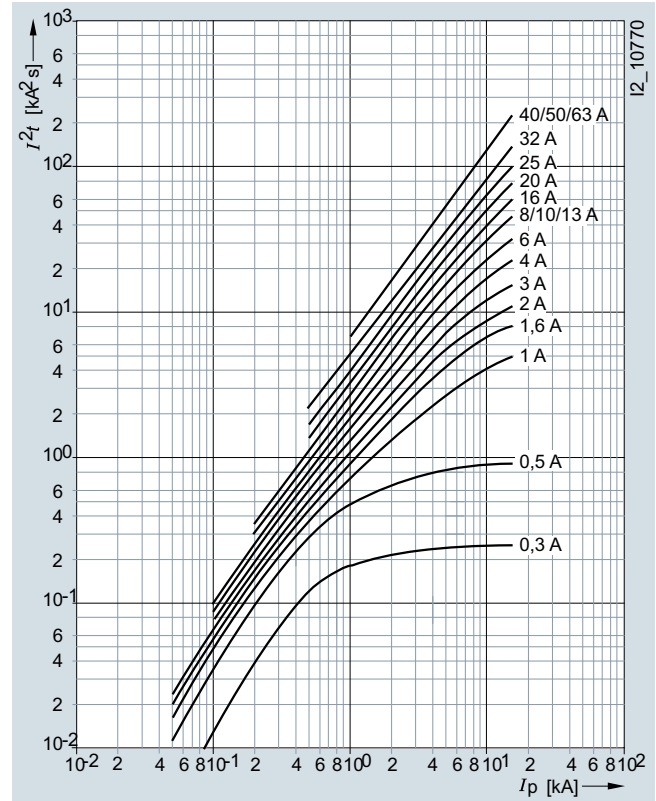

Characteristic C

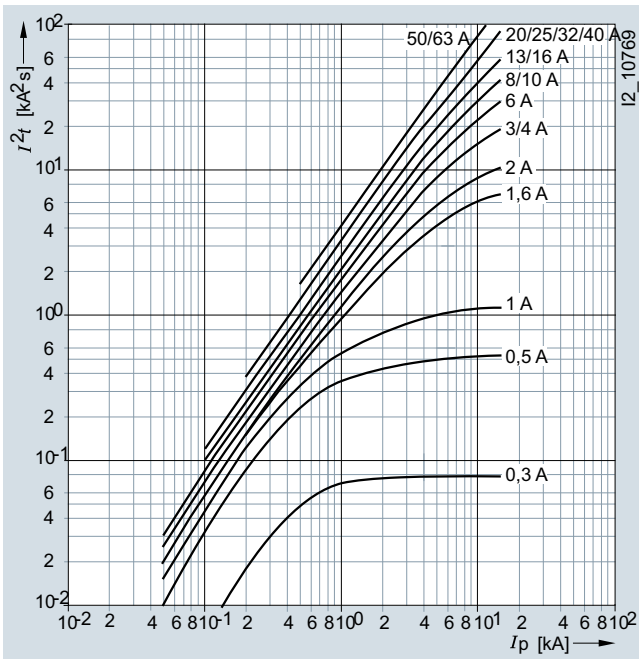

Let-through I^2t values 5SJ6... - KS (AC)

Characteristic B

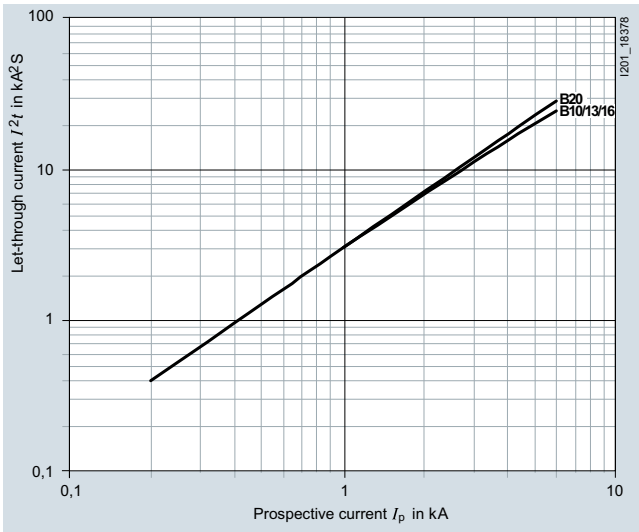

Characteristic C

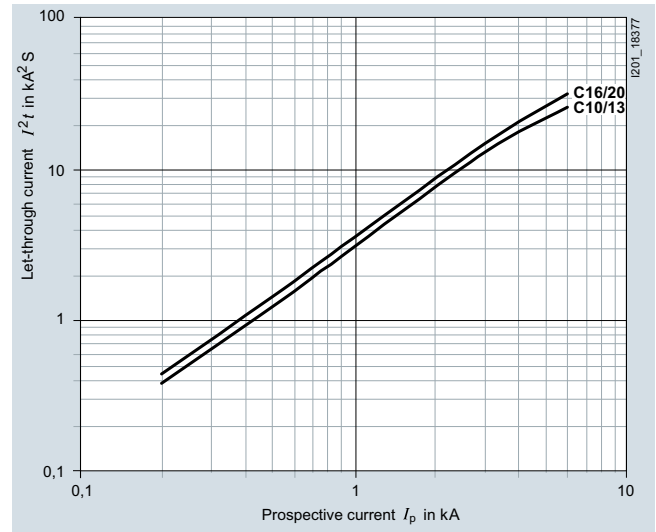

Let-through I^2t values 5SY30 (AC)

Characteristic B

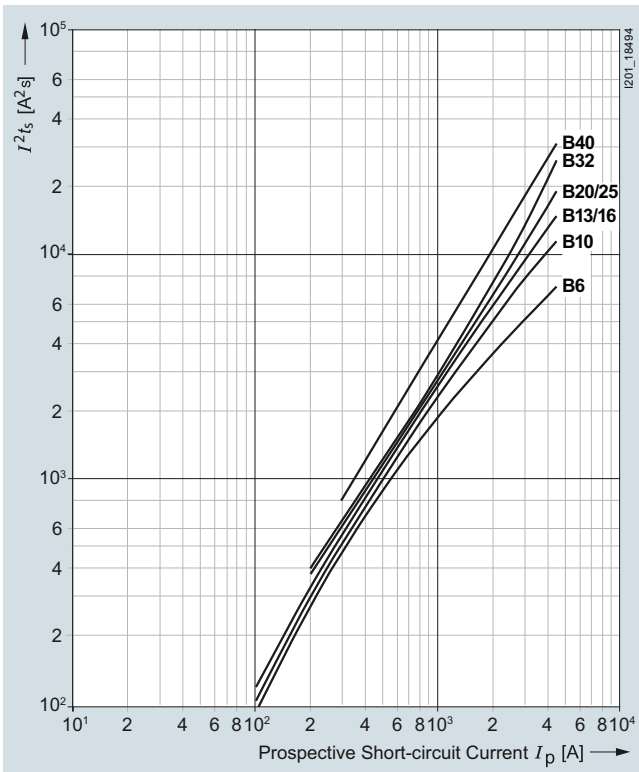

Characteristic C

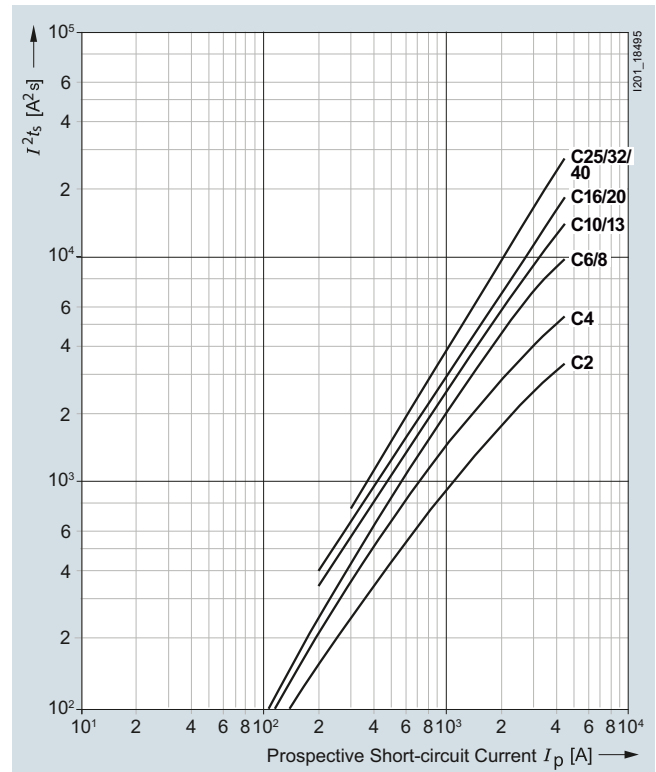

Miniature Circuit Breakers

Configuration and dimensioning

Let-through I^2t values 5SY60 (AC)

Characteristic B

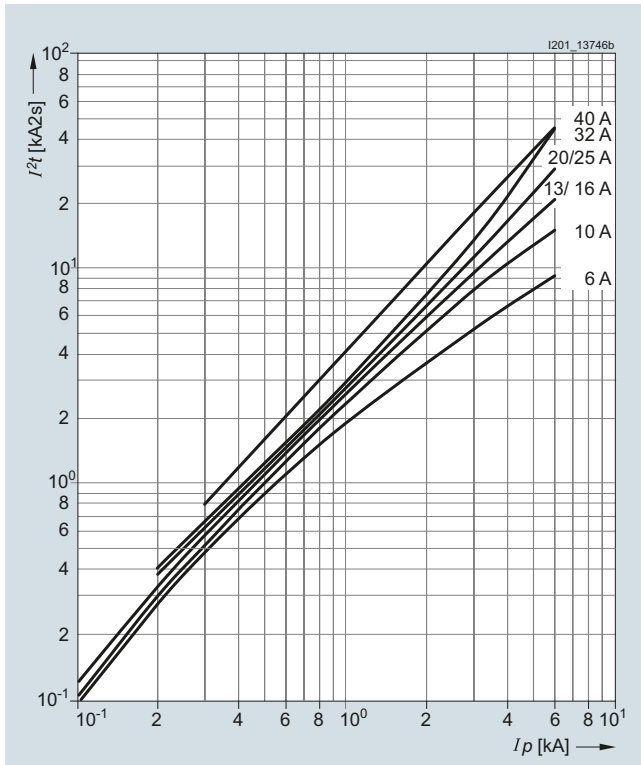

Characteristic C

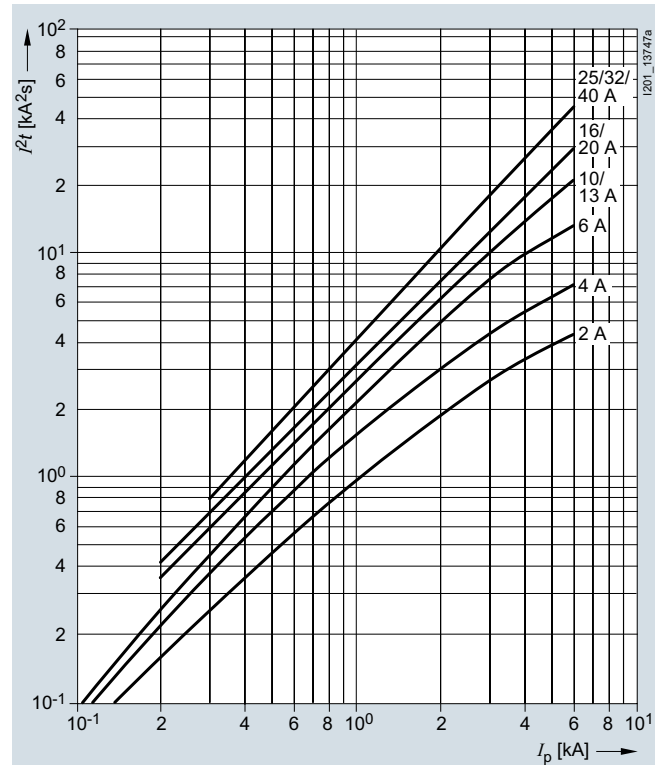

Selectivity of miniature circuit breakers/fuses

Distribution systems are usually set up as radial networks. An overcurrent protection device is required for each reduction of the conductor cross-section. This produces a series connection staggered according to rated currents, which should, if possible, be "selective".

Selectivity means that, in the event of a fault, only the protective device that is directly next to the fault in the current circuit is tripped. This means that current paths in parallel can maintain a power flow.

In the case of miniature circuit breakers with upstream fuses, the selectivity limit depends largely on the current limitation and tripping characteristics of the miniature circuit breaker and the melting I^2t value of the fuse.

This produces different selectivity limits for miniature circuit breakers with different characteristics and rated breaking capacity.

The following tables provide information on the short-circuit currents up to which selectivity exists between miniature circuit breakers and upstream fuses according to DIN VDE 0636-2. The values specified in kA are limit values that were determined under unfavorable test conditions. Under normal practical conditions, you can often expect considerably better values, depending on the upstream fuses.

In the event of a short-circuit, there is selectivity between the 5SY4, 5SY7, 5SP4, 5SJ4...-HG.. miniature circuit breakers and melting fuses according to DIN VDE 0636-2 up to the specified values in kA.

Selectivity limit values of 3NA miniature circuit breakers/fuses in kA, operational class gG

Downstream miniature circuit breakers	I_n [A] ¹⁾	Upstream fuses								
		16 A	20 A	25 A	35 A	50 A	63 A	80 A	100 A	125 A
5SY6 (without 5SY60)										
Characteristic B	6	0.3	0.4	0.7	1.2	3.0	3.2	T	T	--
	10	--	0.4	0.6	1.0	2.2	3.0	5.0	T	--
	13	--	--	0.5	1.0	2.2	3.0	5.0	T	--
	16	--	--	--	1.0	2.0	2.4	4.0	T	--
	20	--	--	--	--	2.0	2.4	4.0	T	--
	25	--	--	--	--	--	2.0	3.5	T	--
	32	--	--	--	--	--	1.7	2.0	T	--
	40	--	--	--	--	--	--	2.0	4.0	--
	50	--	--	--	--	--	--	--	4.0	--
	50	--	--	--	--	--	--	--	4.0	--
Characteristic C	≤ 2	0.3	0.5	1.2	1.7	T	T	T	T	--
	3	0.3	0.4	0.8	1.4	4.0	5.0	T	T	--
	4	0.3	0.4	0.6	1.1	3.0	4.0	T	T	--
	6	--	0.4	0.6	1.0	2.4	3.2	T	T	--
	8	--	--	0.5	0.9	1.4	2.6	3.1	T	--
	10	--	--	0.5	0.9	1.4	2.1	3.1	T	--
	13	--	--	--	0.8	1.3	2.0	3.0	T	--
	16	--	--	--	0.8	1.3	2.0	3.0	T	--
	20	--	--	--	--	1.3	2.0	2.7	T	--
	25	--	--	--	--	--	2.0	2.4	5.0	--
	32	--	--	--	--	--	--	2.2	4.0	--
	40	--	--	--	--	--	--	--	3.5	--
	50	--	--	--	--	--	--	--	3.0	--
	63	--	--	--	--	--	--	--	3.0	--
	5SY4...-5, -6, 5SY7...-6, 5SJ4...-6HG40²⁾									
Characteristic A, B	6	0.3	0.4	0.8	1.4	3.2	4.5	9.0	T	T
	10	--	0.4	0.7	1.2	2.5	3.5	5.0	T	T
	13	--	--	0.7	1.2	2.5	3.5	5.0	T	T
	16	--	--	--	1.0	2.0	2.8	4.2	9.0	T
	20	--	--	--	1.0	2.0	2.6	4.2	9.0	T
	25	--	--	--	--	1.7	2.2	3.7	7.0	T
	32	--	--	--	--	1.7	2.2	3.7	7.0	6.0
	40	--	--	--	--	--	1.6	2.2	4.0	6.0
	50	--	--	--	--	--	--	2.2	4.0	6.0
	63	--	--	--	--	--	--	--	3.0	5.0
	5SY4...-7, 5SY7...-7, 5SJ4...-7HG..²⁾									
Characteristic C	≤ 2	0.3	0.5	1.5	2.0	9.0	T	T	T	T
	3	0.3	0.4	1.1	1.6	5.0	6.0	T	T	T
	4	0.3	0.4	0.9	1.4	3.5	5.0	9.0	T	T
	6	--	0.4	0.8	1.4	2.7	4.5	6.0	T	T
	8	--	--	0.6	1.2	2.2	3.5	5.0	7.0	T
	10	--	--	0.5	1.2	2.0	3.0	4.2	7.0	T
	13	--	--	--	1.0	1.6	2.4	3.4	6.0	T
	16	--	--	--	1.0	1.5	2.2	3.0	6.0	T
	20	--	--	--	--	1.3	2.2	3.0	6.0	T
	25	--	--	--	--	--	2.2	2.9	5.0	9.0
	32	--	--	--	--	--	--	2.4	4.0	7.0
	40	--	--	--	--	--	--	2.0	3.5	4.0
	50	--	--	--	--	--	--	--	3.0	4.0
	63	--	--	--	--	--	--	--	3.0	3.5

T ≙ full selectivity up to rated breaking capacity I_{cn} of the downstream protective device.

¹⁾ In 240/415 V, 50 Hz systems, the selectivity limits are reduced by 10 %. The selectivity limits for adjustable releases apply to the maximum value, I_n = rated current. I_t ≙ tripping current.

²⁾ The values specified for 5SJ4...-HG.. are not according to UL but are the manufacturer's specifications according to EN 60947-2 and apply for voltage U_0 = 230 V ~. For available rated currents, see Catalog LV 10.

Miniature Circuit Breakers

Configuration and dimensioning

Downstream miniature circuit breakers	I_n [A] ¹⁾	Upstream fuses								
		16 A	20 A	25 A	35 A	50 A	63 A	80 A	100 A	125 A
5SY4...-8, 5SY7...-8, 5SJ4...-8HG..²⁾										
Characteristic D	≤ 2	0.3	0.4	1.0	1.8	5.0	7.0	T	T	T
	3	0.3	0.4	0.9	1.5	4.0	5.0	8.0	T	T
	4	--	0.4	0.8	1.2	3.0	3.8	5.5	T	T
	6	--	--	0.7	1.1	2.5	3.1	4.4	8.1	T
	8	--	--	--	0.9	2.1	2.5	3.5	6.2	9.3
	10	--	--	--	--	2.1	2.5	3.5	6.2	9.3
	13	--	--	--	--	--	2.5	3.5	6.2	9.3
	16	--	--	--	--	--	2.2	3.1	5.1	7.5
	20	--	--	--	--	--	--	2.7	4.3	6.3
	25	--	--	--	--	--	--	--	4.0	5.7
	32	--	--	--	--	--	--	--	4.0	5.5
	40	--	--	--	--	--	--	--	3.5	4.8
	50	--	--	--	--	--	--	--	--	4.0
	63	--	--	--	--	--	--	--	--	--

T ≙ full selectivity up to rated breaking capacity I_{cn} of the downstream protective device.

¹⁾ In 240/415 V, 50 Hz systems, the selectivity limits are reduced by 10 %. The selectivity limits for adjustable releases apply to the maximum value, I_n = rated current. I_i ≙ tripping current.

²⁾ The values specified for 5SJ4...-HG.. are not according to UL but are the manufacturer's specifications according to EN 60947-2 and apply for voltage U_0 = 230 V ~. For available rated currents, see Catalog LV 10.

Selectivity limit values of miniature circuit breakers/fuses in kA

Fuse	Operational class	Size	Rated breaking capacity	Rated current	I_{cu} [AC kA]	I_n [A] ¹⁾	Selectivity of the 5SL3... for the upstream fuse 3NA... [kA]													
							3NA	gG	000	120	6	10	16	20	25	32	35	40	50	63
Circuit breaker type: 5SL3...-				6			---	---	0.1	0.2	0.4	0.7	1	1.2	1.6	2	3.2	T	T	T
Characteristic B				10			---	---	0.1	0.2	0.4	0.6	0.9	1.1	1.4	1.8	2.9	T	T	T
I_{cn} [kA] = 4.5				13			---	---	---	---	0.4	0.6	0.9	1.1	1.4	1.8	2.8	T	T	T
				16			---	---	---	---	0.3	0.5	0.7	0.9	1.2	1.5	2.3	4.2	T	T
				20			---	---	---	---	0.3	0.5	0.7	0.9	1.2	1.5	2.2	4	T	T
				25			---	---	---	---	---	0.5	0.7	0.9	1.1	1.4	2.2	3.9	T	T
				32			---	---	---	---	---	---	---	0.9	1.1	1.4	1.9	3.2	3.9	T
				40			---	---	---	---	---	---	---	---	1.2	1.5	2.2	3.9	T	T
				50			---	---	---	---	---	---	---	---	---	1.3	1.9	3.3	4	T
				63			---	---	---	---	---	---	---	---	---	1.8	3.1	3.8	4	T
Circuit breaker type: 5SL3...-				0.3			0.1	0.1	0.7	1.5	T	T	T	T	T	T	T	T	T	T
Characteristic C				0.5			0.1	0.1	0.7	1.5	T	T	T	T	T	T	T	T	T	T
I_{cn} [kA] = 4.5				1				0.1	0.3	0.6	1.4	T	T	T	T	T	T	T	T	T
				1.6					0.2	0.3	0.7	1.3	2.3	3.4	T	T	T	T	T	T
				2					0.1	0.3	0.6	1	1.5	2	2.7	3.5	T	T	T	T
				3					0.1	0.3	0.5	0.9	1.3	1.6	2.2	2.9	T	T	T	T
				4					0.1	0.2	0.5	0.9	1.2	1.6	2.1	2.8	T	T	T	T
				6					0.1	0.2	0.4	0.7	1	1.2	1.6	2	3.2	T	T	T
				8					0.1	0.2	0.4	0.7	0.9	1.1	1.5	1.9	3	T	T	T
				10					0.1	0.2	0.4	0.6	0.9	1.1	1.4	1.8	2.9	T	T	T
				13							0.4	0.6	0.9	1.1	1.4	1.8	2.8	T	T	T
				16							0.3	0.5	0.7	0.9	1.2	1.5	2.3	4.2	T	T
				20							0.3	0.5	0.7	0.9	1.2	1.5	2.2	4	T	T
				25								0.5	0.7	0.9	1.1	1.4	2.2	3.9	T	T
				32								---	---	0.9	1.1	1.4	1.9	3.2	3.9	T
				40								---	---	---	1.2	1.5	2.2	3.9	T	T
				50								---	---	---	---	1.3	1.9	3.3	4	T
				63								---	---	---	---	1.8	3.1	3.8	4	T

T ≙ full selectivity up to I_{cu}/I_{cn} rated short-circuit breaking capacity of the downstream protective device.

¹⁾ In 240/415 V, 50 Hz systems, the selectivity limits are reduced by 10 %. The selectivity limits for adjustable releases apply to the maximum value, I_n = rated current. I_i ≙ tripping current.

Selectivity limit values of miniature circuit breakers/fuses in kA

		Selectivity of the 5SL3... for the upstream fuse 3NA... [kA]						
Fuse		3NA						
Operational class		gG						
Size		00						
Rated breaking capacity	I_{cu} [AC kA]	120						
Rated current	I_n [A] ¹⁾	35	50	63	80	100	125	160
Circuit breaker type:								
5SL3...-								
Characteristic B	10	0.9	1.4	1.8	2.9	T	T	T
I_{cn} [kA] = 4.5	13	0.9	1.4	1.8	2.8	T	T	T
	16	0.7	1.2	1.5	2.3	4.1	T	T
	20	0.7	1.2	1.5	2.2	4	T	T
	25	0.7	1.2	1.4	2.2	3.8	T	T
	32	---	1.1	1.4	1.9	3.2	4.4	T
	40	---	1.2	1.5	2.2	3.8	T	T
	50	---	---	1.3	1.9	3.2	T	T
	63	---	---	---	1.8	3	4.3	T
Circuit breaker type:								
5SL3...-								
Characteristic C	0.3	T	T	T	T	T	T	T
I_{cn} [kA] = 4.5	0.5	T	T	T	T	T	T	T
	1	T	T	T	T	T	T	T
	1.6	2.3	T	T	T	T	T	T
	2	1.5	2.8	3.5	T	T	T	T
	3	1.3	2.2	2.9	T	T	T	T
	4	1.2	2.2	2.8	T	T	T	T
	6	1	1.6	2	3.2	T	T	T
	8	0.9	1.5	1.9	3	T	T	T
	10	0.9	1.4	1.8	2.9	T	T	T
	13	0.9	1.4	1.8	2.8	T	T	T
	16	0.7	1.2	1.5	2.3	4.1	T	T
	20	0.7	1.2	1.5	2.2	4	T	T
	25	0.7	1.2	1.4	2.2	3.8	T	T
	32	---	1.1	1.4	1.9	3.2	4.4	T
	40	---	1.2	1.5	2.2	3.8	T	T
	50	---	---	1.3	1.9	3.2	T	T
	63	---	---	---	1.8	3	4.3	T

T $\hat{=}$ full selectivity up to I_{cu}/I_{cn} rated short-circuit breaking capacity of the downstream protective device.

¹⁾ In 240/415 V, 50 Hz systems, the selectivity limits are reduced by 10 %.
The selectivity limits for adjustable releases apply to the maximum value,
 I_n = rated current. I_T $\hat{=}$ tripping current.

Miniature Circuit Breakers

Configuration and dimensioning

Selectivity limit values of miniature circuit breakers/fuses in kA

		Selectivity of the 5SL3... for the upstream fuse 3NA... [kA]													
Fuse		3NA													
Operational class		gG													
Size		0													
Rated breaking capacity	I_{cu} [AC kA]	120													
Rated current	I_n [A] ¹⁾	6	10	16	20	25	32	35	40	50	63	80	100	125	160
Circuit breaker type:	6	---	---	0.1	0.2	0.4	0.7	1	1.2	1.6	1.9	3.1	T	T	T
5SL3...-	10	---	---	0.1	0.2	0.4	0.6	0.9	1.1	1.4	1.7	2.8	T	T	T
Characteristic B	13	---	---	---	---	0.4	0.6	0.9	1.1	1.4	1.6	2.8	T	T	T
I_{cn} [kA] = 4.5	16	---	---	---	---	0.3	0.5	0.7	0.9	1.2	1.4	2.2	4	T	T
	20	---	---	---	---	0.3	0.5	0.7	0.9	1.1	1.3	2.2	3.8	T	T
	25	---	---	---	---	---	0.5	0.7	0.9	1.1	1.3	2.1	3.7	T	T
	32	---	---	---	---	---	---	---	0.9	1.1	1.3	1.9	3.1	4.4	T
	40	---	---	---	---	---	---	---	---	1.2	1.4	2.2	3.7	T	T
	50	---	---	---	---	---	---	---	---	---	1.2	1.8	3.1	T	T
	63	---	---	---	---	---	---	---	---	---	---	1.7	2.9	4.3	T
Circuit breaker type:	0.3	0.1	0.3	1	1.8	T	T	T	T	T	T	T	T	T	T
5SL3...-	0.5	0.1	0.3	1	1.8	T	T	T	T	T	T	T	T	T	T
Characteristic C	1	---	0.1	0.4	0.7	1.4	T	T	T	T	T	T	T	T	T
I_{cn} [kA] = 4.5	1.6	---	0.1	0.2	0.3	0.7	1.3	2.3	3.4	T	T	T	T	T	T
	2	---	0.1	0.2	0.3	0.6	1	1.5	2	2.7	3.2	T	T	T	T
	3	---	0.1	0.2	0.3	0.5	0.9	1.3	1.6	2.2	2.6	T	T	T	T
	4	---	0.1	0.2	0.3	0.5	0.9	1.2	1.6	2.1	2.5	4.4	T	T	T
	6	---	---	0.1	0.2	0.4	0.7	1	1.2	1.6	1.9	3.1	T	T	T
	8	---	---	0.1	0.2	0.4	0.7	0.9	1.1	1.5	1.8	2.9	T	T	T
	10	---	---	0.1	0.2	0.4	0.6	0.9	1.1	1.4	1.7	2.8	T	T	T
	13	---	---	---	---	0.4	0.6	0.9	1.1	1.4	1.6	2.8	T	T	T
	16	---	---	---	---	0.3	0.5	0.7	0.9	1.2	1.4	2.2	4	T	T
	20	---	---	---	---	0.3	0.5	0.7	0.9	1.1	1.3	2.2	3.8	T	T
	25	---	---	---	---	---	0.5	0.7	0.9	1.1	1.3	2.1	3.7	T	T
	32	---	---	---	---	---	---	---	0.9	1.1	1.3	1.9	3.1	4.4	T
	40	---	---	---	---	---	---	---	---	1.2	1.4	2.2	3.7	T	T
	50	---	---	---	---	---	---	---	---	---	1.2	1.8	3.1	T	T
	63	---	---	---	---	---	---	---	---	---	---	1.7	2.9	4.3	T

T ≙ full selectivity up to I_{cu}/I_{cn} rated short-circuit breaking capacity of the downstream protective device.

¹⁾ In 240/415 V, 50 Hz systems, the selectivity limits are reduced by 10 %.
The selectivity limits for adjustable releases apply to the maximum value,
 I_n = rated current. I_t ≙ tripping current.

Selectivity limit values of miniature circuit breakers/fuses in kA

		Selectivity of the 5SL3... for the upstream fuse 3NA... [kA]													
Fuse		3NA													
Operational class		gG													
Size		1													
Rated breaking capacity	I_{cu} [AC kA]	120													
Rated current	I_n [A] ¹⁾	16	20	25	35	40	50	63	80	100	125	160	200	224	250
Circuit breaker type:	6	0.1	0.2	0.4	0.9	1	1.6	1.9	3.1	T	T	T	T	T	T
5SL3...-.	10	0.1	0.2	0.4	0.8	1	1.4	1.7	2.8	T	T	T	T	T	T
Characteristic B	13	---	---	0.4	0.8	1	1.4	1.6	2.8	T	T	T	T	T	T
I_{cn} [kA] = 4.5	16	---	---	0.3	0.7	0.8	1.2	1.4	2.2	4	T	T	T	T	T
	20	---	---	0.3	0.7	0.8	1.1	1.3	2.2	3.8	T	T	T	T	T
	25	---	---	---	0.7	0.8	1.1	1.3	2.1	3.7	T	T	T	T	T
	32	---	---	---	---	0.8	1.1	1.3	1.9	3.1	4.3	T	T	T	T
	40	---	---	---	---	---	1.2	1.4	2.2	3.7	T	T	T	T	T
	50	---	---	---	---	---	---	1.2	1.8	3.1	T	T	T	T	T
	63	---	---	---	---	---	---	---	1.7	2.9	4.3	T	T	T	T
Circuit breaker type:	0.3	0.7	1.6	T	T	T	T	T	T	T	T	T	T	T	T
5SL3...-.	0.5	0.7	1.6	T	T	T	T	T	T	T	T	T	T	T	T
Characteristic C	1	0.3	0.6	1.4	T	T	T	T	T	T	T	T	T	T	T
I_{cn} [kA] = 4.5	1.6	0.2	0.3	0.7	2	2.5	T	T	T	T	T	T	T	T	T
	2	0.2	0.3	0.6	1.4	1.7	2.7	3.2	T	T	T	T	T	T	T
	3	0.1	0.3	0.5	1.2	1.4	2.2	2.6	T	T	T	T	T	T	T
	4	0.1	0.2	0.5	1.1	1.3	2.1	2.5	4.4	T	T	T	T	T	T
	6	0.1	0.2	0.4	0.9	1	1.6	1.9	3.1	T	T	T	T	T	T
	8	0.1	0.2	0.4	0.9	1	1.5	1.8	2.9	T	T	T	T	T	T
	10	0.1	0.2	0.4	0.8	1	1.4	1.7	2.8	T	T	T	T	T	T
	13	---	---	0.4	0.8	1	1.4	1.6	2.8	T	T	T	T	T	T
	16	---	---	0.3	0.7	0.8	1.2	1.4	2.2	4	T	T	T	T	T
	20	---	---	0.3	0.7	0.8	1.1	1.3	2.2	3.8	T	T	T	T	T
	25	---	---	---	0.7	0.8	1.1	1.3	2.1	3.7	T	T	T	T	T
	32	---	---	---	---	0.8	1.1	1.3	1.9	3.1	4.3	T	T	T	T
	40	---	---	---	---	---	1.2	1.4	2.2	3.7	T	T	T	T	T
	50	---	---	---	---	---	---	1.2	1.8	3.1	T	T	T	T	T
	63	---	---	---	---	---	---	---	1.7	2.9	4.3	T	T	T	T

T $\hat{=}$ full selectivity up to I_{cu}/I_{cn} rated short-circuit breaking capacity of the downstream protective device.

¹⁾ In 240/415 V, 50 Hz systems, the selectivity limits are reduced by 10 %.
The selectivity limits for adjustable releases apply to the maximum value,
 I_n = rated current. I_t $\hat{=}$ tripping current.

Miniature Circuit Breakers

Configuration and dimensioning

Selectivity limit values of miniature circuit breakers/fuses in kA

		Selectivity of the 5SL3... for the upstream fuse 3NA... [kA]													
Fuse		3NA													
Operational class		gG													
Size		2													
Rated breaking capacity	I_{cu} [AC kA]	120													
Rated current	I_n [A] ¹⁾	35	50	63	80	100	125	160	200	224	250	300	315	355	400
Circuit breaker type:	6	0.9	1.6	1.9	3.1	T	T	T	T	T	T	T	T	T	T
5SL3...-	10	0.9	1.4	1.7	2.8	T	T	T	T	T	T	T	T	T	T
Characteristic B	13	0.9	1.4	1.7	2.8	T	T	T	T	T	T	T	T	T	T
I_{cn} [kA] = 4.5	16	0.7	1.2	1.4	2.2	3.9	T	T	T	T	T	T	T	T	T
	20	0.7	1.1	1.4	2.2	3.7	T	T	T	T	T	T	T	T	T
	25	0.7	1.1	1.4	2.1	3.6	T	T	T	T	T	T	T	T	T
	32	---	1.1	1.3	1.9	3	4.3	T	T	T	T	T	T	T	T
	40	---	1.2	1.4	2.2	3.6	T	T	T	T	T	T	T	T	T
	50	---	---	1.2	1.8	3.1	T	T	T	T	T	T	T	T	T
	63	---	---	---	1.7	2.9	4.2	T	T	T	T	T	T	T	T
Circuit breaker type:	0.3	T	T	T	T	T	T	T	T	T	T	T	T	T	T
5SL3...-	0.5	T	T	T	T	T	T	T	T	T	T	T	T	T	T
Characteristic C	1	T	T	T	T	T	T	T	T	T	T	T	T	T	T
I_{cn} [kA] = 4.5	1.6	2.2	T	T	T	T	T	T	T	T	T	T	T	T	T
	2	1.5	2.7	3.3	T	T	T	T	T	T	T	T	T	T	T
	3	1.3	2.2	2.7	T	T	T	T	T	T	T	T	T	T	T
	4	1.2	2.1	2.6	4.4	T	T	T	T	T	T	T	T	T	T
	6	0.9	1.6	1.9	3.1	T	T	T	T	T	T	T	T	T	T
	8	0.9	1.5	1.8	2.9	T	T	T	T	T	T	T	T	T	T
	10	0.9	1.4	1.7	2.8	T	T	T	T	T	T	T	T	T	T
	13	0.9	1.4	1.7	2.8	T	T	T	T	T	T	T	T	T	T
	16	0.7	1.2	1.4	2.2	3.9	T	T	T	T	T	T	T	T	T
	20	0.7	1.1	1.4	2.2	3.7	T	T	T	T	T	T	T	T	T
	25	0.7	1.1	1.4	2.1	3.6	T	T	T	T	T	T	T	T	T
	32	---	1.1	1.3	1.9	3	4.3	T	T	T	T	T	T	T	T
	40	---	1.2	1.4	2.2	3.6	T	T	T	T	T	T	T	T	T
	50	---	---	1.2	1.8	3.1	T	T	T	T	T	T	T	T	T
	63	---	---	---	1.7	2.9	4.2	T	T	T	T	T	T	T	T

T $\hat{=}$ full selectivity up to I_{cu}/I_{cn} rated short-circuit breaking capacity of the downstream protective device.

¹⁾ In 240/415 V, 50 Hz systems, the selectivity limits are reduced by 10 %.
The selectivity limits for adjustable releases apply to the maximum value,
 I_n = rated current. I_t $\hat{=}$ tripping current.

Selectivity limit values of miniature circuit breakers/fuses in kA

		Selectivity of the 5SL3... for the upstream fuse 3NA... [kA]									
Fuse		3NA									
Operational class		gG									
Size		3									
Rated breaking capacity	I_{cu} [AC kA]	120									
Rated current	I_n [A] ¹⁾	200	224	250	300	315	355	400	425	500	630
Circuit breaker type:											
5SL3...-											
Characteristic B	6	T	T	T	T	T	T	T	T	T	T
I_{cn} [kA] = 4.5	10	T	T	T	T	T	T	T	T	T	T
	13	T	T	T	T	T	T	T	T	T	T
	16	T	T	T	T	T	T	T	T	T	T
	20	T	T	T	T	T	T	T	T	T	T
	25	T	T	T	T	T	T	T	T	T	T
	32	T	T	T	T	T	T	T	T	T	T
	40	T	T	T	T	T	T	T	T	T	T
	50	T	T	T	T	T	T	T	T	T	T
	63	T	T	T	T	T	T	T	T	T	T
	Circuit breaker type:										
5SL3...-											
Characteristic C	0.3	T	T	T	T	T	T	T	T	T	T
I_{cn} [kA] = 4.5	0.5	T	T	T	T	T	T	T	T	T	T
	1	T	T	T	T	T	T	T	T	T	T
	1.6	T	T	T	T	T	T	T	T	T	T
	2	T	T	T	T	T	T	T	T	T	T
	3	T	T	T	T	T	T	T	T	T	T
	4	T	T	T	T	T	T	T	T	T	T
	6	T	T	T	T	T	T	T	T	T	T
	8	T	T	T	T	T	T	T	T	T	T
	10	T	T	T	T	T	T	T	T	T	T
	13	T	T	T	T	T	T	T	T	T	T
	16	T	T	T	T	T	T	T	T	T	T
	20	T	T	T	T	T	T	T	T	T	T
	25	T	T	T	T	T	T	T	T	T	T
	32	T	T	T	T	T	T	T	T	T	T
	40	T	T	T	T	T	T	T	T	T	T
	50	T	T	T	T	T	T	T	T	T	T
	63	T	T	T	T	T	T	T	T	T	T

T ≙ full selectivity up to I_{cu}/I_{cn} rated short-circuit breaking capacity of the downstream protective device.

¹⁾ In 240/415 V, 50 Hz systems, the selectivity limits are reduced by 10 %.
The selectivity limits for adjustable releases apply to the maximum value,
 I_n = rated current. I_T ≙ tripping current.

Miniature Circuit Breakers

Configuration and dimensioning

Selectivity limit values of miniature circuit breakers/fuses in kA

		Selectivity of the 5SL3... for the upstream fuse 3NA... [kA]								
Fuse		3NA								
Operational class		gG								
Size		4					4a			
Rated breaking capacity	I_{cu} [AC kA]	120								
Rated current	I_n [A] ¹⁾	630	800	1000	1250	500	630	800	1000	1250
Circuit breaker type:										
5SL3...-	6	T	T	T	T	T	T	T	T	T
Characteristic B	10	T	T	T	T	T	T	T	T	T
I_{cn} [kA] = 4.5	13	T	T	T	T	T	T	T	T	T
	16	T	T	T	T	T	T	T	T	T
	20	T	T	T	T	T	T	T	T	T
	25	T	T	T	T	T	T	T	T	T
	32	T	T	T	T	T	T	T	T	T
	40	T	T	T	T	T	T	T	T	T
	50	T	T	T	T	T	T	T	T	T
	63	T	T	T	T	T	T	T	T	T
Circuit breaker type:										
5SL3...-	0.3	T	T	T	T	T	T	T	T	T
Characteristic C	0.5	T	T	T	T	T	T	T	T	T
I_{cn} [kA] = 4.5	1	T	T	T	T	T	T	T	T	T
	1.6	T	T	T	T	T	T	T	T	T
	2	T	T	T	T	T	T	T	T	T
	3	T	T	T	T	T	T	T	T	T
	4	T	T	T	T	T	T	T	T	T
	6	T	T	T	T	T	T	T	T	T
	8	T	T	T	T	T	T	T	T	T
	10	T	T	T	T	T	T	T	T	T
	13	T	T	T	T	T	T	T	T	T
	16	T	T	T	T	T	T	T	T	T
	20	T	T	T	T	T	T	T	T	T
	25	T	T	T	T	T	T	T	T	T
	32	T	T	T	T	T	T	T	T	T
	40	T	T	T	T	T	T	T	T	T
	50	T	T	T	T	T	T	T	T	T
	63	T	T	T	T	T	T	T	T	T

T ≙ full selectivity up to I_{cu}/I_{cn} rated short-circuit breaking capacity of the downstream protective device.

¹⁾ In 240/415 V, 50 Hz systems, the selectivity limits are reduced by 10 %.
The selectivity limits for adjustable releases apply to the maximum value,
 I_n = rated current. I_t ≙ tripping current.

Selectivity limit values of miniature circuit breakers/fuses in kA

		Selectivity of the 5SL4... for the upstream fuse 3NA... [kA]														
Fuse		3NA														
Operational class		gG														
Size		000														
Rated breaking capacity		I_{cu} [AC kA]														
Rated current		I_n [A] ¹⁾														
		6	10	16	20	25	32	35	40	50	63	80	100	125	160	
Circuit breaker type: 5SL4...-.	1	---	---	6.9	T	T	T	T	T	T	T	T	T	T	T	
	2	---	---	---	0.5	2.4	T	T	T	T	T	T	T	T	T	
	Characteristic B	3	---	---	---	0.9	2.3	5.4	T	T	T	T	T	T	T	
	I_{cn} [kA] = 10	4	---	---	---	---	0.7	1.2	1.9	2.6	4.3	6.3	T	T	T	T
		6	---	---	---	---	0.6	0.9	1.5	2	2.8	4.1	8.7	T	T	T
		8	---	---	---	---	0.5	0.9	1.3	1.7	2.4	3.2	5.8	T	T	T
		10	---	---	---	---	0.5	0.8	1.2	1.5	2	2.6	4.6	T	T	T
		13	---	---	---	---	0.4	0.7	1.1	1.4	1.8	2.3	3.9	8.6	T	T
		16	---	---	---	---	---	0.7	0.9	1.2	1.6	2.1	3.2	6.3	8.2	T
		20	---	---	---	---	---	0.6	0.9	1.1	1.5	1.9	2.9	6.1	7.2	T
		25	---	---	---	---	---	0.6	0.9	1.1	1.4	1.8	2.8	5.5	6.7	T
		32	---	---	---	---	---	---	---	0.9	1.2	1.6	2.4	4.5	5.9	T
		40	---	---	---	---	---	---	---	---	1.2	1.6	2.4	4.5	5.1	T
		50	---	---	---	---	---	---	---	---	---	1.4	2	3.6	4.6	8.6
63	---	---	---	---	---	---	---	---	---	---	1.9	3.3	4.1	7.1		
Circuit breaker type: 5SL4...-.	0.3	---	---	T	T	T	T	T	T	T	T	T	T	T	T	
	0.5	---	---	T	T	T	T	T	T	T	T	T	T	T	T	
	Characteristic C	1	---	---	1	3.3	T	T	T	T	T	T	T	T	T	
	I_{cn} [kA] = 10	1.6	---	---	---	---	1.1	3.2	T	T	T	T	T	T	T	T
		2	---	---	---	---	0.7	1.5	2.5	3.9	5.8	T	T	T	T	T
		3	---	---	---	---	0.6	1.1	1.7	2.4	3.7	5.7	T	T	T	T
		4	---	---	---	---	0.6	0.9	1.5	2	2.9	4.1	7.8	T	T	T
		6	---	---	---	---	0.5	0.8	1.2	1.5	2.1	2.8	5.2	T	T	T
		8	---	---	---	---	---	0.6	0.8	1.1	1.4	1.8	2.8	7.1	9.9	T
		10	---	---	---	---	---	0.6	0.8	1.1	1.4	1.8	2.8	7.1	9.9	T
		13	---	---	---	---	---	0.6	0.8	1.1	1.4	1.8	2.8	5.9	7	T
		16	---	---	---	---	---	0.6	0.8	1.1	1.4	1.8	2.8	5.9	7	T
		20	---	---	---	---	---	0.5	0.8	0.9	1.2	1.6	2.4	4.6	6	T
		25	---	---	---	---	---	0.5	0.8	0.9	1.2	1.6	2.4	4.6	6	T
32		---	---	---	---	---	---	---	0.8	1.1	1.4	2.1	4.1	5.3	T	
40		---	---	---	---	---	---	---	---	1.1	1.4	2.1	4.2	5.3	9.7	
50	---	---	---	---	---	---	---	---	---	1.2	2	3.6	4.3	7.1		
63	---	---	---	---	---	---	---	---	---	---	2	3.6	4.3	7.1		
Circuit breaker type: 5SL4...-.	0.3	---	---	T	T	T	T	T	T	T	T	T	T	T	T	
	0.5	---	---	T	T	T	T	T	T	T	T	T	T	T	T	
	Characteristic D	1	---	---	0.5	1.4	4.7	T	T	T	T	T	T	T	T	
	I_{cn} [kA] = 10	1.6	---	---	---	---	0.9	1.6	2.7	4.2	7.4	T	T	T	T	T
		2	---	---	---	---	0.6	1.3	2.1	2.7	4.1	7.1	T	T	T	T
		3	---	---	---	---	0.6	1	1.5	2	2.8	4.1	8.4	T	T	T
		4	---	---	---	---	0.5	0.8	1.3	1.7	2.3	3.2	5.6	T	T	T
		6	---	---	---	---	---	0.7	1	1.3	1.9	2.5	4.2	T	T	T
		8	---	---	---	---	---	0.5	0.7	0.8	1.1	1.5	2.4	5.4	7.2	T
		10	---	---	---	---	---	0.5	0.7	0.8	1.1	1.5	2.4	5.4	7.2	T
		13	---	---	---	---	---	0.5	0.7	0.8	1.1	1.5	2.4	4.6	6.1	T
		16	---	---	---	---	---	0.5	0.7	0.8	1.1	1.5	2.4	4.6	6.1	T
		20	---	---	---	---	---	0.4	0.6	0.8	1	1.4	2.2	4.3	5.5	T
		25	---	---	---	---	---	0.4	0.6	0.8	1	1.4	2.2	4.3	5.5	T
32		---	---	---	---	---	---	---	0.8	1.1	1.5	2.3	4.4	5.5	T	
40		---	---	---	---	---	---	---	---	0.9	1.2	1.9	3.7	4.7	8.8	
50	---	---	---	---	---	---	---	---	---	---	1.6	2.9	3.7	6.6		
63	---	---	---	---	---	---	---	---	---	---	1.6	2.9	3.7	6.6		

T ≙ full selectivity up to I_{cu}/I_{cn} rated short-circuit breaking capacity of the downstream protective device.

¹⁾ In 240/415 V, 50 Hz systems, the selectivity limits are reduced by 10 %.
The selectivity limits for adjustable releases apply to the maximum value,
 I_n = rated current. I_t ≙ tripping current.

Miniature Circuit Breakers

Configuration and dimensioning

Selectivity limit values of miniature circuit breakers/fuses in kA

		Selectivity of the 5SL4... for the upstream fuse 3NA... [kA]						
Fuse		3NA						
Operational class		gG						
Size		00						
Rated breaking capacity	I_{cu} [AC kA]	120						
Rated current	I_n [A] ¹⁾	35	50	63	80	100	125	160
Circuit breaker type:	1	T	T	T	T	T	T	T
5SL4...-	2	T	T	T	T	T	T	T
Characteristic B	3	5.4	T	T	T	T	T	T
I_{cn} [kA] = 10	4	1.9	4.5	6.3	T	T	T	T
	6	1.5	2.9	4.1	8.6	T	T	T
	8	1.3	2.4	3.2	5.8	T	T	T
	10	1.2	2	2.6	4.6	T	T	T
	13	1.1	1.9	2.3	3.9	8.3	T	T
	16	0.9	1.7	2.1	3.2	6.2	T	T
	20	0.9	1.5	1.9	2.9	6	8.5	T
	25	0.9	1.4	1.8	2.8	5.4	7.4	T
	32	---	1.3	1.6	2.4	4.4	6.5	T
	40	---	1.2	1.6	2.4	4.5	5.5	T
	50	---	---	1.4	2	3.5	5.3	8.3
	63	---	---	---	1.9	3.3	4.7	7
Circuit breaker type:	0.3	T	T	T	T	T	T	T
5SL4...-	0.5	T	T	T	T	T	T	T
Characteristic C	1	T	T	T	T	T	T	T
I_{cn} [kA] = 10	1.6	T	T	T	T	T	T	T
	2	2.5	6	T	T	T	T	T
	3	1.7	3.9	5.7	T	T	T	T
	4	1.5	3	4.1	7.8	T	T	T
	6	1.2	2.1	2.8	5.2	T	T	T
	8	0.8	1.4	1.8	2.8	7	T	T
	10	0.8	1.4	1.8	2.8	7	T	T
	13	0.8	1.4	1.8	2.8	5.7	8.3	T
	16	0.8	1.4	1.8	2.8	5.7	8.3	T
	20	0.8	1.3	1.6	2.4	4.5	6.6	T
	25	0.8	1.3	1.6	2.4	4.5	6.6	T
	32	---	1.1	1.4	2.1	4	6.1	9.9
	40	---	1.1	1.4	2.1	4.1	6	9.4
	50	---	---	1.2	2	3.6	4.9	7
	63	---	---	---	2	3.6	4.9	7
Circuit breaker type:	0.3	T	T	T	T	T	T	T
5SL4...-	0.5	T	T	T	T	T	T	T
Characteristic C	1	T	T	T	T	T	T	T
I_{cn} [kA] = 10	1.6	2.7	9.5	T	T	T	T	T
	2	2.1	4.2	7.1	T	T	T	T
	3	1.5	2.9	4.1	8.4	T	T	T
	4	1.3	2.4	3.2	5.6	T	T	T
	6	1	1.9	2.5	4.2	T	T	T
	8	0.7	1.2	1.5	2.4	5.3	9.6	T
	10	0.7	1.2	1.5	2.4	5.3	9.6	T
	13	0.7	1.2	1.5	2.4	4.5	6.8	T
	16	0.7	1.2	1.5	2.4	4.5	6.8	T
	20	0.6	1.1	1.4	2.2	4.2	6.2	T
	25	0.6	1.1	1.4	2.2	4.2	6.2	T
	32	---	1.1	1.5	2.3	4.3	6.2	T
	40	---	0.9	1.2	1.9	3.6	5.5	8.5
	50	---	---	---	1.6	2.8	4.3	6.5
	63	---	---	---	1.6	2.8	4.3	6.5

T ≙ full selectivity up to I_{cu}/I_{cn} rated short-circuit breaking capacity of the downstream protective device.

¹⁾ In 240/415 V, 50 Hz systems, the selectivity limits are reduced by 10 %.
The selectivity limits for adjustable releases apply to the maximum value,
 I_n = rated current. I_t ≙ tripping current.

Selectivity limit values of miniature circuit breakers/fuses in kA

		Selectivity of the 5SL4... for the upstream fuse 3NA... [kA]													
Fuse		3NA													
Operational class		gG													
Size		0													
Rated breaking capacity		I_{cu} [AC kA] 120													
Rated current		I_n [A] ¹⁾													
		6	10	16	20	25	32	35	40	50	63	80	100	125	160
Circuit breaker type:	1	---	---	T	T	T	T	T	T	T	T	T	T	T	T
5SL4...-	2	---	---	---	0.6	2.4	T	T	T	T	T	T	T	T	T
Characteristic B	3	---	---	---	---	0.9	2.3	5.4	T	T	T	T	T	T	T
I_{cn} [kA] = 10	4	---	---	---	---	0.7	1.2	1.9	2.6	4.2	5.5	T	T	T	T
	6	---	---	---	---	0.6	0.9	1.5	2	2.8	3.6	8.1	T	T	T
	8	---	---	---	---	0.5	0.9	1.3	1.7	2.3	2.9	5.6	T	T	T
	10	---	---	---	---	0.5	0.8	1.2	1.5	2	2.4	4.4	T	T	T
	13	---	---	---	---	0.4	0.7	1.1	1.4	1.8	2.1	3.8	7.7	T	T
	16	---	---	---	---	---	0.7	0.9	1.2	1.6	1.9	3.2	6	T	T
	20	---	---	---	---	---	0.6	0.9	1.1	1.4	1.7	2.9	5.7	8.5	T
	25	---	---	---	---	---	0.6	0.9	1.1	1.4	1.6	2.7	5.1	7.4	T
	32	---	---	---	---	---	---	---	0.9	1.2	1.5	2.3	4.2	6.5	T
	40	---	---	---	---	---	---	---	---	1.2	1.4	2.3	4.3	5.4	T
	50	---	---	---	---	---	---	---	---	---	1.3	2	3.4	5.3	8.6
	63	---	---	---	---	---	---	---	---	---	---	1.8	3.1	4.7	7.2
Circuit breaker type:	0.3	---	---	T	T	T	T	T	T	T	T	T	T	T	T
5SL4...-	0.5	---	---	T	T	T	T	T	T	T	T	T	T	T	T
Characteristic C	1	---	---	0.5	1.1	3.3	T	T	T	T	T	T	T	T	T
I_{cn} [kA] = 10	1.6	---	---	---	0.4	1.1	3.2	T	T	T	T	T	T	T	T
	2	---	---	---	---	0.7	1.5	2.5	3.9	5.7	9.4	T	T	T	T
	3	---	---	---	---	0.6	1.1	1.7	2.4	3.6	4.9	T	T	T	T
	4	---	---	---	---	0.6	0.9	1.5	2	2.9	3.7	7.4	T	T	T
	6	---	---	---	---	0.5	0.8	1.2	1.5	2	2.5	5	T	T	T
	8	---	---	---	---	---	0.6	0.8	1.1	1.4	1.7	2.7	6.7	T	T
	10	---	---	---	---	---	0.6	0.8	1.1	1.4	1.7	2.7	6.7	T	T
	13	---	---	---	---	---	0.6	0.8	1.1	1.4	1.7	2.7	5.2	8.2	T
	16	---	---	---	---	---	0.6	0.8	1.1	1.4	1.7	2.7	5.2	8.2	T
	20	---	---	---	---	---	0.5	0.8	0.9	1.2	1.4	2.3	4.3	6.6	T
	25	---	---	---	---	---	0.5	0.8	0.9	1.2	1.4	2.3	4.3	6.6	T
	32	---	---	---	---	---	---	---	0.8	1.1	1.3	2.1	3.8	6.1	T
	40	---	---	---	---	---	---	---	---	1	1.3	2.1	3.9	6	9.7
	50	---	---	---	---	---	---	---	---	---	1.1	1.9	3.4	4.9	7.1
	63	---	---	---	---	---	---	---	---	---	---	1.9	3.4	4.9	7.1
Circuit breaker type:	0.3	---	0.5	T	T	T	T	T	T	T	T	T	T	T	T
5SL4...-	0.5	---	0.5	T	T	T	T	T	T	T	T	T	T	T	T
Characteristic C	1	---	---	0.4	0.5	1.4	4.7	T	T	T	T	T	T	T	T
I_{cn} [kA] = 10	1.6	---	---	---	---	0.9	1.6	2.7	4.2	7.3	T	T	T	T	T
	2	---	---	---	---	0.6	1.3	2.1	2.7	4	6.5	T	T	T	T
	3	---	---	---	---	0.6	1	1.5	2	2.8	3.6	7.8	T	T	T
	4	---	---	---	---	0.5	0.8	1.3	1.7	2.3	2.8	5.5	T	T	T
	6	---	---	---	---	---	0.7	1	1.3	1.8	2.3	4.1	T	T	T
	8	---	---	---	---	---	0.5	0.7	0.8	1.1	1.4	2.3	5	9.5	T
	10	---	---	---	---	---	0.5	0.7	0.8	1.1	1.4	2.3	5	9.5	T
	13	---	---	---	---	---	0.5	0.7	0.8	1.1	1.4	2.3	4.3	6.7	T
	16	---	---	---	---	---	0.5	0.7	0.8	1.1	1.4	2.3	4.3	6.7	T
	20	---	---	---	---	---	0.4	0.6	0.8	1	1.3	2.1	4	6.2	T
	25	---	---	---	---	---	0.4	0.6	0.8	1	1.3	2.1	4	6.2	T
	32	---	---	---	---	---	---	---	0.8	1.1	1.3	2.2	4.1	6.2	T
	40	---	---	---	---	---	---	---	---	0.9	1.1	1.9	3.5	5.5	8.8
	50	---	---	---	---	---	---	---	---	---	---	1.6	2.7	4.3	6.6
	63	---	---	---	---	---	---	---	---	---	---	1.6	2.7	4.3	6.6

T ≙ full selectivity up to I_{cu}/I_{cn} rated short-circuit breaking capacity of the downstream protective device.

¹⁾ In 240/415 V, 50 Hz systems, the selectivity limits are reduced by 10 %.
The selectivity limits for adjustable releases apply to the maximum value,
 I_n = rated current. I_t ≙ tripping current.

Miniature Circuit Breakers

Configuration and dimensioning

Selectivity limit values of miniature circuit breakers/fuses in kA

		Selectivity of the 5SL4... for the upstream fuse 3NA... [kA]													
Fuse		3NA													
Operational class		gG													
Size		1													
Rated breaking capacity		I_{cu} [AC kA] 120													
Rated current		I_n [A] ¹⁾ 16 20 25 35 40 50 63 80 100 125 160 200 224 250													
Circuit breaker type:	1	9	T	T	T	T	T	T	T	T	T	T	T	T	T
5SL4...-	2	---	0.5	2.4	T	T	T	T	T	T	T	T	T	T	T
Characteristic B	3	---	---	0.9	4.4	7.1	T	T	T	T	T	T	T	T	T
I_{cn} [kA] = 10	4	---	---	0.7	1.7	2.1	4.2	5.5	T	T	T	T	T	T	T
	6	---	---	0.6	1.4	1.7	2.8	3.6	8.1	T	T	T	T	T	T
	8	---	---	0.5	1.2	1.4	2.3	2.9	5.6	T	T	T	T	T	T
	10	---	---	0.5	1.1	1.3	2	2.4	4.4	T	T	T	T	T	T
	13	---	---	0.4	1	1.2	1.8	2.1	3.8	7.7	T	T	T	T	T
	16	---	---	---	0.9	1	1.6	1.9	3.2	6	T	T	T	T	T
	20	---	---	---	0.8	1	1.4	1.7	2.9	5.7	8.5	T	T	T	T
	25	---	---	---	0.8	0.9	1.4	1.6	2.7	5.1	7.4	T	T	T	T
	32	---	---	---	---	0.8	1.2	1.5	2.3	4.2	6.5	T	T	T	T
	40	---	---	---	---	---	1.2	1.4	2.3	4.3	5.4	T	T	T	T
	50	---	---	---	---	---	---	1.3	2	3.4	5.3	8.6	T	T	T
	63	---	---	---	---	---	---	---	1.8	3.1	4.7	7.2	T	T	T
Circuit breaker type:	0.3	T	T	T	T	T	T	T	T	T	T	T	T	T	T
5SL4...-	0.5	T	T	T	T	T	T	T	T	T	T	T	T	T	T
Characteristic C	1	---	1	3.3	T	T	T	T	T	T	T	T	T	T	T
I_{cn} [kA] = 10	1.6	---	0.4	1.1	T	T	T	T	T	T	T	T	T	T	T
	2	---	---	0.7	2.2	2.8	5.7	9.4	T	T	T	T	T	T	T
	3	---	---	0.6	1.5	1.9	3.6	4.9	T	T	T	T	T	T	T
	4	---	---	0.6	1.3	1.6	2.9	3.7	7.4	T	T	T	T	T	T
	6	---	---	0.5	1.1	1.3	2	2.5	5	T	T	T	T	T	T
	8	---	---	---	0.8	0.9	1.4	1.7	2.7	6.7	T	T	T	T	T
	10	---	---	---	0.8	0.9	1.4	1.7	2.7	6.7	T	T	T	T	T
	13	---	---	---	0.8	0.9	1.4	1.7	2.7	5.2	8.2	T	T	T	T
	16	---	---	---	0.8	0.9	1.4	1.7	2.7	5.2	8.2	T	T	T	T
	20	---	---	---	0.7	0.8	1.2	1.4	2.3	4.3	6.6	T	T	T	T
	25	---	---	---	0.7	0.8	1.2	1.4	2.3	4.3	6.6	T	T	T	T
	32	---	---	---	---	0.7	1.1	1.3	2.1	3.8	6.1	T	T	T	T
	40	---	---	---	---	---	1	1.3	2.1	3.9	6	9.7	T	T	T
	50	---	---	---	---	---	---	1.1	1.9	3.4	4.9	7.1	T	T	T
	63	---	---	---	---	---	---	---	1.9	3.4	4.9	7.1	T	T	T
Circuit breaker type:	0.3	T	T	T	T	T	T	T	T	T	T	T	T	T	T
5SL4...-	0.5	T	T	T	T	T	T	T	T	T	T	T	T	T	T
Characteristic D	1	---	0.5	1.4	T	T	T	T	T	T	T	T	T	T	T
I_{cn} [kA] = 10	1.6	---	---	0.9	2.4	3	7.3	T	T	T	T	T	T	T	T
	2	---	---	0.6	1.9	2.2	4	6.5	T	T	T	T	T	T	T
	3	---	---	0.6	1.4	1.7	2.8	3.6	7.8	T	T	T	T	T	T
	4	---	---	0.5	1.1	1.4	2.3	2.8	5.5	T	T	T	T	T	T
	6	---	---	---	1	1.1	1.8	2.3	4.1	T	T	T	T	T	T
	8	---	---	---	0.6	0.7	1.1	1.4	2.3	5	9.5	T	T	T	T
	10	---	---	---	0.6	0.7	1.1	1.4	2.3	5	9.5	T	T	T	T
	13	---	---	---	0.6	0.7	1.1	1.4	2.3	4.3	6.7	T	T	T	T
	16	---	---	---	0.6	0.7	1.1	1.4	2.3	4.3	6.7	T	T	T	T
	20	---	---	---	0.6	0.7	1	1.3	2.1	4	6.2	T	T	T	T
	25	---	---	---	0.6	0.7	1	1.3	2.1	4	6.2	T	T	T	T
	32	---	---	---	---	0.7	1.1	1.3	2.2	4.1	6.2	T	T	T	T
	40	---	---	---	---	---	0.9	1.1	1.9	3.5	5.5	8.8	T	T	T
	50	---	---	---	---	---	---	---	1.6	2.7	4.3	6.6	T	T	T
	63	---	---	---	---	---	---	---	1.6	2.7	4.3	6.6	T	T	T

T $\hat{=}$ full selectivity up to I_{cu}/I_{cn} rated short-circuit breaking capacity of the downstream protective device.

¹⁾ In 240/415 V, 50 Hz systems, the selectivity limits are reduced by 10 %.
The selectivity limits for adjustable releases apply to the maximum value,
 I_n = rated current. I_t $\hat{=}$ tripping current.

Selectivity limit values of miniature circuit breakers/fuses in kA

		Selectivity of the 5SL4... for the upstream fuse 3NA... [kA]													
Fuse		3NA													
Operational class		gG													
Size		2													
Rated breaking capacity	I_{cu} [AC kA]	120													
Rated current	I_n [A] ¹⁾	35	50	63	80	100	125	160	200	224	250	300	315	355	400
Circuit breaker type:	1	T	T	T	T	T	T	T	T	T	T	T	T	T	T
5SL4...-	2	T	T	T	T	T	T	T	T	T	T	T	T	T	T
Characteristic B	3	5.1	T	T	T	T	T	T	T	T	T	T	T	T	T
I_{cn} [kA] = 10	4	1.8	4.2	5.8	T	T	T	T	T	T	T	T	T	T	T
	6	1.5	2.8	3.8	8.1	T	T	T	T	T	T	T	T	T	T
	8	1.3	2.3	3	5.6	T	T	T	T	T	T	T	T	T	T
	10	1.1	2	2.5	4.4	T	T	T	T	T	T	T	T	T	T
	13	1.1	1.8	2.2	3.8	7.4	T	T	T	T	T	T	T	T	T
	16	0.9	1.6	2	3.2	5.8	T	T	T	T	T	T	T	T	T
	20	0.9	1.4	1.8	2.9	5.5	8.2	T	T	T	T	T	T	T	T
	25	0.8	1.4	1.7	2.7	4.9	7.3	T	T	T	T	T	T	T	T
	32	---	1.2	1.5	2.3	4.1	6.4	T	T	T	T	T	T	T	T
	40	---	1.2	1.5	2.3	4.2	5.4	T	T	T	T	T	T	T	T
	50	---	---	1.3	2	3.3	5.2	8.6	T	T	T	T	T	T	T
	63	---	---	---	1.8	3.1	4.6	7.1	T	T	T	T	T	T	T
Circuit breaker type:	0.3	T	T	T	T	T	T	T	T	T	T	T	T	T	T
5SL4...-	0.5	T	T	T	T	T	T	T	T	T	T	T	T	T	T
Characteristic C	1	T	T	T	T	T	T	T	T	T	T	T	T	T	T
I_{cn} [kA] = 10	1.6	T	T	T	T	T	T	T	T	T	T	T	T	T	T
	2	2.4	5.7	T	T	T	T	T	T	T	T	T	T	T	T
	3	1.6	3.6	5.2	T	T	T	T	T	T	T	T	T	T	T
	4	1.4	2.9	3.8	7.4	T	T	T	T	T	T	T	T	T	T
	6	1.1	2	2.6	5	T	T	T	T	T	T	T	T	T	T
	8	0.8	1.4	1.7	2.7	6.5	T	T	T	T	T	T	T	T	T
	10	0.8	1.4	1.7	2.7	6.5	T	T	T	T	T	T	T	T	T
	13	0.8	1.4	1.7	2.7	5	7.9	T	T	T	T	T	T	T	T
	16	0.8	1.4	1.7	2.7	5	7.9	T	T	T	T	T	T	T	T
	20	0.7	1.2	1.5	2.3	4.2	6.5	T	T	T	T	T	T	T	T
	25	0.7	1.2	1.5	2.3	4.2	6.5	T	T	T	T	T	T	T	T
	32	---	1.1	1.3	2.1	3.7	6	T	T	T	T	T	T	T	T
	40	---	1	1.3	2.1	3.8	5.9	9.6	T	T	T	T	T	T	T
	50	---	---	1.2	1.9	3.4	4.8	7.1	T	T	T	T	T	T	T
	63	---	---	---	1.9	3.4	4.8	7.1	T	T	T	T	T	T	T
Circuit breaker type:	0.3	T	T	T	T	T	T	T	T	T	T	T	T	T	T
5SL4...-	0.5	T	T	T	T	T	T	T	T	T	T	T	T	T	T
Characteristic D	1	T	T	T	T	T	T	T	T	T	T	T	T	T	T
I_{cn} [kA] = 10	1.6	2.6	7.3	T	T	T	T	T	T	T	T	T	T	T	T
	2	2	4	6.7	T	T	T	T	T	T	T	T	T	T	T
	3	1.5	2.8	3.8	7.8	T	T	T	T	T	T	T	T	T	T
	4	1.2	2.3	3	5.5	T	T	T	T	T	T	T	T	T	T
	6	1	1.8	2.4	4.1	T	T	T	T	T	T	T	T	T	T
	8	0.7	1.1	1.4	2.3	4.9	9.1	T	T	T	T	T	T	T	T
	10	0.7	1.1	1.4	2.3	4.9	9.1	T	T	T	T	T	T	T	T
	13	0.7	1.1	1.4	2.3	4.2	6.6	T	T	T	T	T	T	T	T
	16	0.7	1.1	1.4	2.3	4.2	6.6	T	T	T	T	T	T	T	T
	20	0.6	1	1.3	2.1	3.9	6.1	T	T	T	T	T	T	T	T
	25	0.6	1	1.3	2.1	3.9	6.1	T	T	T	T	T	T	T	T
	32	---	1.1	1.4	2.2	4	6.1	T	T	T	T	T	T	T	T
	40	---	0.9	1.2	1.9	3.4	5.4	8.8	T	T	T	T	T	T	T
	50	---	---	---	1.6	2.6	4.2	6.6	T	T	T	T	T	T	T
	63	---	---	---	1.6	2.6	4.2	6.6	T	T	T	T	T	T	T

T ≙ full selectivity up to I_{cu}/I_{cn} rated short-circuit breaking capacity of the downstream protective device.

¹⁾ In 240/415 V, 50 Hz systems, the selectivity limits are reduced by 10 %.
The selectivity limits for adjustable releases apply to the maximum value,
 I_n = rated current. I_t ≙ tripping current.

Miniature Circuit Breakers

Configuration and dimensioning

Selectivity limit values of miniature circuit breakers/fuses in kA

		Selectivity of the 5SL4... for the upstream fuse 3NA... [kA]									
Fuse		3NA									
Operational class		gG									
Size		3									
Rated breaking capacity	I_{cu} [AC kA]	120									
Rated current	I_n [A] ¹⁾	200	224	250	300	315	355	400	425	500	630
Circuit breaker type:	1	T	T	T	T	T	T	T	T	T	T
5SL4...-	2	T	T	T	T	T	T	T	T	T	T
Characteristic B	3	T	T	T	T	T	T	T	T	T	T
I_{cn} [kA] = 10	4	T	T	T	T	T	T	T	T	T	T
	6	T	T	T	T	T	T	T	T	T	T
	8	T	T	T	T	T	T	T	T	T	T
	10	T	T	T	T	T	T	T	T	T	T
	13	T	T	T	T	T	T	T	T	T	T
	16	T	T	T	T	T	T	T	T	T	T
	20	T	T	T	T	T	T	T	T	T	T
	25	T	T	T	T	T	T	T	T	T	T
	32	T	T	T	T	T	T	T	T	T	T
	40	T	T	T	T	T	T	T	T	T	T
	50	T	T	T	T	T	T	T	T	T	T
	63	T	T	T	T	T	T	T	T	T	T
Circuit breaker type:	0.3	T	T	T	T	T	T	T	T	T	T
5SL4...-	0.5	T	T	T	T	T	T	T	T	T	T
Characteristic C	1	T	T	T	T	T	T	T	T	T	T
I_{cn} [kA] = 10	1.6	T	T	T	T	T	T	T	T	T	T
	2	T	T	T	T	T	T	T	T	T	T
	3	T	T	T	T	T	T	T	T	T	T
	4	T	T	T	T	T	T	T	T	T	T
	6	T	T	T	T	T	T	T	T	T	T
	8	T	T	T	T	T	T	T	T	T	T
	10	T	T	T	T	T	T	T	T	T	T
	13	T	T	T	T	T	T	T	T	T	T
	16	T	T	T	T	T	T	T	T	T	T
	20	T	T	T	T	T	T	T	T	T	T
	25	T	T	T	T	T	T	T	T	T	T
	32	T	T	T	T	T	T	T	T	T	T
	40	T	T	T	T	T	T	T	T	T	T
	50	T	T	T	T	T	T	T	T	T	T
	63	T	T	T	T	T	T	T	T	T	T
Circuit breaker type:	0.3	T	T	T	T	T	T	T	T	T	T
5SL4...-	0.5	T	T	T	T	T	T	T	T	T	T
Characteristic D	1	T	T	T	T	T	T	T	T	T	T
I_{cn} [kA] = 10	1.6	T	T	T	T	T	T	T	T	T	T
	2	T	T	T	T	T	T	T	T	T	T
	3	T	T	T	T	T	T	T	T	T	T
	4	T	T	T	T	T	T	T	T	T	T
	6	T	T	T	T	T	T	T	T	T	T
	8	T	T	T	T	T	T	T	T	T	T
	10	T	T	T	T	T	T	T	T	T	T
	13	T	T	T	T	T	T	T	T	T	T
	16	T	T	T	T	T	T	T	T	T	T
	20	T	T	T	T	T	T	T	T	T	T
	25	T	T	T	T	T	T	T	T	T	T
	32	T	T	T	T	T	T	T	T	T	T
	40	T	T	T	T	T	T	T	T	T	T
	50	T	T	T	T	T	T	T	T	T	T
	63	T	T	T	T	T	T	T	T	T	T

T ≙ full selectivity up to I_{cu}/I_{cn} rated short-circuit breaking capacity of the downstream protective device.

¹⁾ In 240/415 V, 50 Hz systems, the selectivity limits are reduced by 10 %.
The selectivity limits for adjustable releases apply to the maximum value,
 I_n = rated current. I_t ≙ tripping current.

Selectivity limit values of miniature circuit breakers/fuses in kA

		Selectivity of the 5SL4... for the upstream fuse 3NA... [kA]								
Fuse		3NA								
Operational class		gG								
Size		4				4a				
Rated breaking capacity	I_{cu} [AC kA]	120								
Rated current	I_n [A] ¹⁾	630	800	1000	1250	500	630	800	1000	1250
Circuit breaker type:	1	T	T	T	T	T	T	T	T	T
5SL4...-.	2	T	T	T	T	T	T	T	T	T
Characteristic B	3	T	T	T	T	T	T	T	T	T
I_{cn} [kA] = 10	4	T	T	T	T	T	T	T	T	T
	6	T	T	T	T	T	T	T	T	T
	8	T	T	T	T	T	T	T	T	T
	10	T	T	T	T	T	T	T	T	T
	13	T	T	T	T	T	T	T	T	T
	16	T	T	T	T	T	T	T	T	T
	20	T	T	T	T	T	T	T	T	T
	25	T	T	T	T	T	T	T	T	T
	32	T	T	T	T	T	T	T	T	T
	40	T	T	T	T	T	T	T	T	T
	50	T	T	T	T	T	T	T	T	T
	63	T	T	T	T	T	T	T	T	T
Circuit breaker type:	0.3	T	T	T	T	T	T	T	T	T
5SL4...-.	0.5	T	T	T	T	T	T	T	T	T
Characteristic C	1	T	T	T	T	T	T	T	T	T
I_{cn} [kA] = 10	1.6	T	T	T	T	T	T	T	T	T
	2	T	T	T	T	T	T	T	T	T
	3	T	T	T	T	T	T	T	T	T
	4	T	T	T	T	T	T	T	T	T
	6	T	T	T	T	T	T	T	T	T
	8	T	T	T	T	T	T	T	T	T
	10	T	T	T	T	T	T	T	T	T
	13	T	T	T	T	T	T	T	T	T
	16	T	T	T	T	T	T	T	T	T
	20	T	T	T	T	T	T	T	T	T
	25	T	T	T	T	T	T	T	T	T
	32	T	T	T	T	T	T	T	T	T
	40	T	T	T	T	T	T	T	T	T
	50	T	T	T	T	T	T	T	T	T
	63	T	T	T	T	T	T	T	T	T
Circuit breaker type:	0.3	T	T	T	T	T	T	T	T	T
5SL4...-.	0.5	T	T	T	T	T	T	T	T	T
Characteristic D	1	T	T	T	T	T	T	T	T	T
I_{cn} [kA] = 10	1.6	T	T	T	T	T	T	T	T	T
	2	T	T	T	T	T	T	T	T	T
	3	T	T	T	T	T	T	T	T	T
	4	T	T	T	T	T	T	T	T	T
	6	T	T	T	T	T	T	T	T	T
	8	T	T	T	T	T	T	T	T	T
	10	T	T	T	T	T	T	T	T	T
	13	T	T	T	T	T	T	T	T	T
	16	T	T	T	T	T	T	T	T	T
	20	T	T	T	T	T	T	T	T	T
	25	T	T	T	T	T	T	T	T	T
	32	T	T	T	T	T	T	T	T	T
	40	T	T	T	T	T	T	T	T	T
	50	T	T	T	T	T	T	T	T	T
	63	T	T	T	T	T	T	T	T	T

T ≙ full selectivity up to I_{cu}/I_{cn} rated short-circuit breaking capacity of the downstream protective device.

¹⁾ In 240/415 V, 50 Hz systems, the selectivity limits are reduced by 10 %.
The selectivity limits for adjustable releases apply to the maximum value,
 I_n = rated current. I_t ≙ tripping current.

Miniature Circuit Breakers

Configuration and dimensioning

Selectivity limit values of miniature circuit breakers/fuses in kA

		Selectivity of the 5SL6... for the upstream fuse 3NA... [kA]													
Fuse		3NA													
Operational class		gG													
Size		000													
Rated breaking capacity	I_{cu} [AC kA]	120													
Rated current	I_n [A] ¹⁾	6	10	16	20	25	32	35	40	50	63	80	100	125	160
Circuit breaker type:	6	---	---	0.1	0.2	0.4	0.7	1	1.2	1.6	2	3.2	T	T	T
5SL6...-	10	---	---	0.1	0.2	0.4	0.6	0.9	1.1	1.4	1.8	2.9	5.4	T	T
Characteristic B	13	---	---	---	---	0.4	0.6	0.9	1.1	1.4	1.8	2.8	5.7	T	T
I_{cn} [kA] = 10	16	---	---	---	---	0.3	0.5	0.7	0.9	1.2	1.5	2.3	4.2	5	T
	20	---	---	---	---	0.3	0.5	0.7	0.9	1.2	1.5	2.2	4	4.9	T
	25	---	---	---	---	---	0.5	0.7	0.9	1.1	1.4	2.2	3.9	4.8	T
	32	---	---	---	---	---	---	---	0.9	1.1	1.4	1.9	3.2	3.9	T
	40	---	---	---	---	---	---	---	---	1.2	1.5	2.2	3.9	4.7	T
	50	---	---	---	---	---	---	---	---	---	1.3	1.9	3.3	4	T
	63	---	---	---	---	---	---	---	---	---	---	1.8	3.1	3.8	T
Circuit breaker type:	0.5	0.1	0.1	0.7	1.5	T	T	T	T	T	T	T	T	T	T
5SL6...-	1	---	0.1	0.3	0.6	1.4	4.9	T	T	T	T	T	T	T	T
Characteristic C	1.6	---	---	0.2	0.3	0.7	1.3	2.3	3.4	T	T	T	T	T	T
I_{cn} [kA] = 10	2	---	---	0.1	0.3	0.6	1	1.5	2	2.7	3.5	5.8	T	T	T
	3	---	---	0.1	0.3	0.5	0.9	1.3	1.6	2.2	2.9	4.9	T	T	T
	4	---	---	0.1	0.2	0.5	0.9	1.2	1.6	2.1	2.8	4.6	T	T	T
	6	---	---	0.1	0.2	0.5	0.9	1.2	1.6	2.1	2.8	4.6	T	T	T
	8	---	---	0.1	0.2	0.4	0.7	0.9	1.1	1.5	1.9	3	5.8	T	T
	10	---	---	0.1	0.2	0.4	0.6	0.9	1.1	1.4	1.8	2.9	5.4	T	T
	13	---	---	---	---	0.4	0.6	0.9	1.1	1.4	1.8	2.8	5.7	T	T
	16	---	---	---	---	0.3	0.5	0.7	0.9	1.2	1.5	2.3	4.2	5	T
	20	---	---	---	---	0.3	0.5	0.7	0.9	1.2	1.5	2.2	4	4.9	T
	25	---	---	---	---	---	0.5	0.7	0.9	1.1	1.4	2.2	3.9	4.8	T
	32	---	---	---	---	---	---	---	0.9	1.1	1.4	1.9	3.2	3.9	T
	40	---	---	---	---	---	---	---	---	1.2	1.5	2.2	3.9	4.7	T
	50	---	---	---	---	---	---	---	---	---	1.3	1.9	3.3	4	T
	63	---	---	---	---	---	---	---	---	---	---	1.8	3.1	3.8	T

T $\hat{=}$ full selectivity up to I_{cu}/I_{cn} rated short-circuit breaking capacity of the downstream protective device.

¹⁾ In 240/415 V, 50 Hz systems, the selectivity limits are reduced by 10 %.
The selectivity limits for adjustable releases apply to the maximum value,
 I_n = rated current, I_t $\hat{=}$ tripping current.

Selectivity limit values of miniature circuit breakers/fuses in kA

		Selectivity of the 5SL6... for the upstream fuse 3NA... [kA]						
Fuse		3NA						
Operational class		gG						
Size		00						
Rated breaking capacity	I_{cu} [AC kA]	120						
Rated current	I_n [A] ¹⁾	35	50	63	80	100	125	160
Circuit breaker type:								
5SL6...-	6	1	1.6	2	3.2	T	T	T
Characteristic B	10	0.9	1.4	1.8	2.9	5.2	T	T
I_{cn} [kA] = 6	13	0.9	1.4	1.8	2.8	5.5	T	T
	16	0.7	1.2	1.5	2.3	4.1	5.5	T
	20	0.7	1.2	1.5	2.2	4	5.5	T
	25	0.7	1.2	1.4	2.2	3.8	5.3	T
	32	---	1.1	1.4	1.9	3.2	4.4	T
	40	---	1.2	1.5	2.2	3.8	5.5	T
	50	---	---	1.3	1.9	3.2	4.6	T
	63	---	---	---	1.8	3	4.3	T
Circuit breaker type:								
5SL6...-	0.5	T	T	T	T	T	T	T
Characteristic C	1	T	T	T	T	T	T	T
I_{cn} [kA] = 6	1.6	2.3	T	T	T	T	T	T
	2	1.5	2.8	3.5	5.8	T	T	T
	3	1.3	2.2	2.9	4.9	T	T	T
	4	1.2	2.2	2.8	4.6	T	T	T
	6	1.2	2.2	2.8	4.6	T	T	T
	8	0.9	1.5	1.9	3	5.7	T	T
	10	0.9	1.4	1.8	2.9	5.2	T	T
	13	0.9	1.4	1.8	2.8	5.5	T	T
	16	0.7	1.2	1.5	2.3	4.1	5.5	T
	20	0.7	1.2	1.5	2.2	4	5.5	T
	25	0.7	1.2	1.4	2.2	3.8	5.3	T
	32	---	1.1	1.4	1.9	3.2	4.4	T
	40	---	1.2	1.5	2.2	3.8	5.5	T
	50	---	---	1.3	1.9	3.2	4.6	T
	63	---	---	---	1.8	3	4.3	T

T $\hat{=}$ full selectivity up to I_{cu}/I_{cn} rated short-circuit breaking capacity of the downstream protective device.

¹⁾ In 240/415 V, 50 Hz systems, the selectivity limits are reduced by 10 %.
The selectivity limits for adjustable releases apply to the maximum value,
 I_n = rated current. I_t $\hat{=}$ tripping current.

Miniature Circuit Breakers

Configuration and dimensioning

Selectivity limit values of miniature circuit breakers/fuses in kA

		Selectivity of the 5SL6... for the upstream fuse 3NA... [kA]													
Fuse		3NA													
Operational class		gG													
Size		0													
Rated breaking capacity		120													
Rated current		I_n [A] ¹⁾													
		6	10	16	20	25	32	35	40	50	63	80	100	125	160
Circuit breaker type:	6	---	---	0.1	0.2	0.4	0.7	1	1.2	1.6	1.9	3.1	T	T	T
5SL6...-	10	---	---	0.1	0.2	0.4	0.6	0.9	1.1	1.4	1.7	2.8	5	T	T
Characteristic B	13	---	---	---	---	0.4	0.6	0.9	1.1	1.4	1.6	2.8	5.2	T	T
I_{cn} [kA] = 6	16	---	---	---	---	0.3	0.5	0.7	0.9	1.2	1.4	2.2	4	5.5	T
	20	---	---	---	---	0.3	0.5	0.7	0.9	1.1	1.3	2.2	3.8	5.5	T
	25	---	---	---	---	---	0.5	0.7	0.9	1.1	1.3	2.1	3.7	5.3	T
	32	---	---	---	---	---	---	---	0.9	1.1	1.3	1.9	3.1	4.3	T
	40	---	---	---	---	---	---	---	---	1.2	1.4	2.2	3.7	5.4	T
	50	---	---	---	---	---	---	---	---	---	1.2	1.8	3.1	4.5	T
	63	---	---	---	---	---	---	---	---	---	---	1.7	2.9	4.3	T
Circuit breaker type:	0.5	0.1	0.3	1	1.8	T	T	T	T	T	T	T	T	T	T
5SL6...-	1	---	0.1	0.4	0.7	1.4	4.9	T	T	T	T	T	T	T	T
Characteristic C	1.6	---	0.1	0.2	0.3	0.7	1.3	2.3	3.4	T	T	T	T	T	T
I_{cn} [kA] = 6	2	---	0.1	0.2	0.3	0.6	1	1.5	2	2.7	3.2	5.6	T	T	T
	3	---	0.1	0.2	0.3	0.5	0.9	1.3	1.6	2.2	2.6	4.8	T	T	T
	4	---	0.1	0.2	0.3	0.5	0.9	1.2	1.6	2.1	2.5	4.4	T	T	T
	6	---	0.1	0.2	0.3	0.5	0.9	1.2	1.6	2.1	2.5	4.4	T	T	T
	8	---	---	0.1	0.2	0.4	0.7	0.9	1.1	1.5	1.8	2.9	5.4	T	T
	10	---	---	0.1	0.2	0.4	0.6	0.9	1.1	1.4	1.7	2.8	5	T	T
	13	---	---	---	---	0.4	0.6	0.9	1.1	1.4	1.6	2.8	5.2	T	T
	16	---	---	---	---	0.3	0.5	0.7	0.9	1.2	1.4	2.2	4	5.5	T
	20	---	---	---	---	0.3	0.5	0.7	0.9	1.1	1.3	2.2	3.8	5.5	T
	25	---	---	---	---	---	0.5	0.7	0.9	1.1	1.3	2.1	3.7	5.3	T
	32	---	---	---	---	---	---	---	0.9	1.1	1.3	1.9	3.1	4.3	T
	40	---	---	---	---	---	---	---	---	1.2	1.4	2.2	3.7	5.4	T
	50	---	---	---	---	---	---	---	---	---	1.2	1.8	3.1	4.5	T
	63	---	---	---	---	---	---	---	---	---	---	1.7	2.9	4.3	T

T $\hat{=}$ full selectivity up to I_{cu}/I_{cn} rated short-circuit breaking capacity of the downstream protective device.

¹⁾ In 240/415 V, 50 Hz systems, the selectivity limits are reduced by 10 %.
The selectivity limits for adjustable releases apply to the maximum value,
 I_n = rated current, I_t $\hat{=}$ tripping current.

Selectivity limit values of miniature circuit breakers/fuses in kA

		Selectivity of the 5SL6... for the upstream fuse 3NA... [kA]													
Fuse		3NA													
Operational class		gG													
Size		1													
Rated breaking capacity	I_{cu} [AC kA]	120													
Rated current	I_n [A] ¹⁾	16	20	25	35	40	50	63	80	100	125	160	200	224	250
Circuit breaker type:	6	0.1	0.2	0.4	0.9	1	1.6	1.9	3.1	T	T	T	T	T	T
5SL6...-	10	0.1	0.2	0.4	0.8	1	1.4	1.7	2.8	5	T	T	T	T	T
Characteristic B	13	---	---	0.4	0.8	1	1.4	1.6	2.8	5.2	T	T	T	T	T
I_{cn} [kA] = 6	16	---	---	0.3	0.7	0.8	1.2	1.4	2.2	4	5.5	T	T	T	T
	20	---	---	0.3	0.7	0.8	1.1	1.3	2.2	3.8	5.5	T	T	T	T
	25	---	---	---	0.7	0.8	1.1	1.3	2.1	3.7	5.3	T	T	T	T
	32	---	---	---	---	0.8	1.1	1.3	1.9	3.1	4.3	T	T	T	T
	40	---	---	---	---	---	1.2	1.4	2.2	3.7	5.4	T	T	T	T
	50	---	---	---	---	---	---	1.2	1.8	3.1	4.5	T	T	T	T
	63	---	---	---	---	---	---	---	1.7	2.9	4.3	T	T	T	T
Circuit breaker type:	0.5	0.7	1.6	T	T	T	T	T	T	T	T	T	T	T	T
5SL6...-	1	0.3	0.6	1.4	T	T	T	T	T	T	T	T	T	T	T
Characteristic C	1.6	0.2	0.3	0.7	2	2.5	T	T	T	T	T	T	T	T	T
I_{cn} [kA] = 6	2	0.2	0.3	0.6	1.4	1.7	2.7	3.2	5.6	T	T	T	T	T	T
	3	0.1	0.3	0.5	1.2	1.4	2.2	2.6	4.8	T	T	T	T	T	T
	4	0.1	0.2	0.5	1.1	1.3	2.1	2.5	4.4	T	T	T	T	T	T
	6	0.1	0.2	0.5	1.1	1.3	2.1	2.5	4.4	T	T	T	T	T	T
	8	0.1	0.2	0.4	0.9	1	1.5	1.8	2.9	5.4	T	T	T	T	T
	10	0.1	0.2	0.4	0.8	1	1.4	1.7	2.8	5	T	T	T	T	T
	13	---	---	0.4	0.8	1	1.4	1.6	2.8	5.2	T	T	T	T	T
	16	---	---	0.3	0.7	0.8	1.2	1.4	2.2	4	5.5	T	T	T	T
	20	---	---	0.3	0.7	0.8	1.1	1.3	2.2	3.8	5.5	T	T	T	T
	25	---	---	---	0.7	0.8	1.1	1.3	2.1	3.7	5.3	T	T	T	T
	32	---	---	---	---	0.8	1.1	1.3	1.9	3.1	4.3	T	T	T	T
	40	---	---	---	---	---	1.2	1.4	2.2	3.7	5.4	T	T	T	T
	50	---	---	---	---	---	---	1.2	1.8	3.1	4.5	T	T	T	T
	63	---	---	---	---	---	---	---	1.7	2.9	4.3	T	T	T	T

T $\hat{=}$ full selectivity up to I_{cu}/I_{cn} rated short-circuit breaking capacity of the downstream protective device.

¹⁾ In 240/415 V, 50 Hz systems, the selectivity limits are reduced by 10 %.
The selectivity limits for adjustable releases apply to the maximum value,
 I_n = rated current, I_t $\hat{=}$ tripping current.

Miniature Circuit Breakers

Configuration and dimensioning

Selectivity limit values of miniature circuit breakers/fuses in kA

		Selectivity of the 5SL6... for the upstream fuse 3NA... [kA]													
Fuse		3NA													
Operational class		gG													
Size		2													
Rated breaking capacity	I_{cu} [AC kA]	120													
Rated current	I_n [A] ¹⁾	35	50	63	80	100	125	160	200	224	250	300	315	355	400
Circuit breaker type:	6	0.9	1.6	1.9	3.1	5.9	T	T	T	T	T	T	T	T	T
5SL6...-	10	0.9	1.4	1.7	2.8	4.9	T	T	T	T	T	T	T	T	T
Characteristic B	13	0.9	1.4	1.7	2.8	5	T	T	T	T	T	T	T	T	T
I_{cn} [kA] = 6	16	0.7	1.2	1.4	2.2	3.9	5.4	T	T	T	T	T	T	T	T
	20	0.7	1.1	1.4	2.2	3.7	5.4	T	T	T	T	T	T	T	T
	25	0.7	1.1	1.4	2.1	3.6	5.2	T	T	T	T	T	T	T	T
	32	---	1.1	1.3	1.9	3	4.3	T	T	T	T	T	T	T	T
	40	---	1.2	1.4	2.2	3.6	5.3	T	T	T	T	T	T	T	T
	50	---	---	1.2	1.8	3.1	4.5	T	T	T	T	T	T	T	T
	63	---	---	---	1.7	2.9	4.2	T	T	T	T	T	T	T	T
Circuit breaker type:	0.5	T	T	T	T	T	T	T	T	T	T	T	T	T	T
5SL6...-	1	T	T	T	T	T	T	T	T	T	T	T	T	T	T
Characteristic C	1.6	2.2	T	T	T	T	T	T	T	T	T	T	T	T	T
I_{cn} [kA] = 6	2	1.5	2.7	3.3	5.6	T	T	T	T	T	T	T	T	T	T
	3	1.3	2.2	2.7	4.8	T	T	T	T	T	T	T	T	T	T
	4	1.2	2.1	2.6	4.4	T	T	T	T	T	T	T	T	T	T
	6	1.2	2.1	2.6	4.4	T	T	T	T	T	T	T	T	T	T
	8	0.9	1.5	1.8	2.9	5.3	T	T	T	T	T	T	T	T	T
	10	0.9	1.4	1.7	2.8	4.9	T	T	T	T	T	T	T	T	T
	13	0.9	1.4	1.7	2.8	5	T	T	T	T	T	T	T	T	T
	16	0.7	1.2	1.4	2.2	3.9	5.4	T	T	T	T	T	T	T	T
	20	0.7	1.1	1.4	2.2	3.7	5.4	T	T	T	T	T	T	T	T
	25	0.7	1.1	1.4	2.1	3.6	5.2	T	T	T	T	T	T	T	T
	32	---	1.1	1.3	1.9	3	4.3	T	T	T	T	T	T	T	T
	40	---	1.2	1.4	2.2	3.6	5.3	T	T	T	T	T	T	T	T
	50	---	---	1.2	1.8	3.1	4.5	T	T	T	T	T	T	T	T
	63	---	---	---	1.7	2.9	4.2	T	T	T	T	T	T	T	T

T $\hat{=}$ full selectivity up to I_{cu}/I_{cn} rated short-circuit breaking capacity of the downstream protective device.

¹⁾ In 240/415 V, 50 Hz systems, the selectivity limits are reduced by 10 %.
The selectivity limits for adjustable releases apply to the maximum value,
 I_n = rated current, I_t $\hat{=}$ tripping current.

Selectivity limit values of miniature circuit breakers/fuses in kA

		Selectivity of the 5SL6... for the upstream fuse 3NA... [kA]									
Fuse		3NA									
Operational class		gG									
Size		3									
Rated breaking capacity	I_{cu} [AC kA]	120									
Rated current	I_n [A] ¹⁾	200	224	250	300	315	355	400	425	500	630
Circuit breaker type:											
5SL6...-											
Characteristic B											
I_{cn} [kA] = 10											
	6	T	T	T	T	T	T	T	T	T	T
	10	T	T	T	T	T	T	T	T	T	T
	13	T	T	T	T	T	T	T	T	T	T
	16	T	T	T	T	T	T	T	T	T	T
	20	T	T	T	T	T	T	T	T	T	T
	25	T	T	T	T	T	T	T	T	T	T
	32	T	T	T	T	T	T	T	T	T	T
	40	T	T	T	T	T	T	T	T	T	T
	50	T	T	T	T	T	T	T	T	T	T
	63	T	T	T	T	T	T	T	T	T	T
Circuit breaker type:											
5SL6...-											
Characteristic C											
I_{cn} [kA] = 6											
	0.3	T	T	T	T	T	T	T	T	T	T
	1	T	T	T	T	T	T	T	T	T	T
	1.6	T	T	T	T	T	T	T	T	T	T
	2	T	T	T	T	T	T	T	T	T	T
	3	T	T	T	T	T	T	T	T	T	T
	4	T	T	T	T	T	T	T	T	T	T
	6	T	T	T	T	T	T	T	T	T	T
	8	T	T	T	T	T	T	T	T	T	T
	10	T	T	T	T	T	T	T	T	T	T
	13	T	T	T	T	T	T	T	T	T	T
	16	T	T	T	T	T	T	T	T	T	T
	20	T	T	T	T	T	T	T	T	T	T
	25	T	T	T	T	T	T	T	T	T	T
	32	T	T	T	T	T	T	T	T	T	T
	40	T	T	T	T	T	T	T	T	T	T
	50	T	T	T	T	T	T	T	T	T	T
	63	T	T	T	T	T	T	T	T	T	T

T $\hat{=}$ full selectivity up to I_{cu}/I_{cn} rated short-circuit breaking capacity of the downstream protective device.

¹⁾ In 240/415 V, 50 Hz systems, the selectivity limits are reduced by 10 %.
The selectivity limits for adjustable releases apply to the maximum value,
 I_n = rated current, I_i $\hat{=}$ tripping current.

Miniature Circuit Breakers

Configuration and dimensioning

Selectivity limit values of miniature circuit breakers/fuses in kA

		Selectivity of the 5SL6... for the upstream fuse 3NA... [kA]													
Fuse		3NA													
Operational class		gG													
Size		4					4a								
Rated breaking capacity	I_{cu} [AC kA]	120													
Rated current	I_n [A] ¹⁾	630	800	1000	1250	500	630	800	1000	1250					
Circuit breaker type:															
5SL6...-															
Characteristic B	10	T	T	T	T	T	T	T	T	T	T	T	T	T	T
I_{cn} [kA] = 6	13	T	T	T	T	T	T	T	T	T	T	T	T	T	T
	16	T	T	T	T	T	T	T	T	T	T	T	T	T	T
	20	T	T	T	T	T	T	T	T	T	T	T	T	T	T
	25	T	T	T	T	T	T	T	T	T	T	T	T	T	T
	32	T	T	T	T	T	T	T	T	T	T	T	T	T	T
	40	T	T	T	T	T	T	T	T	T	T	T	T	T	T
	50	T	T	T	T	T	T	T	T	T	T	T	T	T	T
	63	T	T	T	T	T	T	T	T	T	T	T	T	T	T
Circuit breaker type:															
5SL6...-															
Characteristic C	0.5	T	T	T	T	T	T	T	T	T	T	T	T	T	T
I_{cn} [kA] = 6	1	T	T	T	T	T	T	T	T	T	T	T	T	T	T
	1.6	T	T	T	T	T	T	T	T	T	T	T	T	T	T
	2	T	T	T	T	T	T	T	T	T	T	T	T	T	T
	3	T	T	T	T	T	T	T	T	T	T	T	T	T	T
	4	T	T	T	T	T	T	T	T	T	T	T	T	T	T
	6	T	T	T	T	T	T	T	T	T	T	T	T	T	T
	8	T	T	T	T	T	T	T	T	T	T	T	T	T	T
	10	T	T	T	T	T	T	T	T	T	T	T	T	T	T
	13	T	T	T	T	T	T	T	T	T	T	T	T	T	T
	16	T	T	T	T	T	T	T	T	T	T	T	T	T	T
	20	T	T	T	T	T	T	T	T	T	T	T	T	T	T
	25	T	T	T	T	T	T	T	T	T	T	T	T	T	T
	32	T	T	T	T	T	T	T	T	T	T	T	T	T	T
	40	T	T	T	T	T	T	T	T	T	T	T	T	T	T
	50	T	T	T	T	T	T	T	T	T	T	T	T	T	T
	63	T	T	T	T	T	T	T	T	T	T	T	T	T	T

T ≙ full selectivity up to I_{cu}/I_{cn} rated short-circuit breaking capacity of the downstream protective device.

¹⁾ In 240/415 V, 50 Hz systems, the selectivity limits are reduced by 10 %.
The selectivity limits for adjustable releases apply to the maximum value,
 I_n = rated current, I_t ≙ tripping current.

Selectivity limit values of miniature circuit breakers/fuses in kA

		Selectivity of the 5SP4... for the upstream fuse 3NA... [kA]													
Fuse		3NA													
Operational class		gG													
Size		000													
Rated breaking capacity	I_{cu} [AC kA]	120													
Rated current	I_n [A] ¹⁾	6	10	16	20	25	32	35	40	50	63	80	100	125	160
Circuit breaker type:															
5SP4...-															
Characteristic B/C	40	---	---	---	---	---	---	---	---	0.8	1	1.5	2.8	3.6	6.9
I_{cn} [kA] = 10	50	---	---	---	---	---	---	---	---	---	0.9	1.5	2.8	3.3	5.3
	63	---	---	---	---	---	---	---	---	---	---	1.1	2	2.5	4.5
	80	---	---	---	---	---	---	---	---	---	---	---	1.6	1.9	3.5
	100	---	---	---	---	---	---	---	---	---	---	---	---	1.8	3.2
	125	---	---	---	---	---	---	---	---	---	---	---	---	---	4.1
Circuit breaker type:															
5SP4...-															
Characteristic D	40	---	---	---	---	---	---	---	---	---	0.9	1.4	2.5	3.1	5.7
I_{cn} [kA] = 10	50	---	---	---	---	---	---	---	---	---	0.9	1.4	2.6	3.3	5.6
	63	---	---	---	---	---	---	---	---	---	---	1	1.6	1.9	4
	80	---	---	---	---	---	---	---	---	---	---	---	---	---	3
	100	---	---	---	---	---	---	---	---	---	---	---	---	---	2.6

¹⁾ In 240/415 V, 50 Hz systems, the selectivity limits are reduced by 10 %.
The selectivity limits for adjustable releases apply to the maximum value,
 I_n = rated current, I_t ≙ tripping current.

Selectivity limit values of miniature circuit breakers/fuses in kA

		Selectivity of the 5SP4... for the upstream fuse 3NA... [kA]						
Fuse		3NA						
Operational class		gG						
Size		00						
Rated breaking capacity	I_{cu} [AC kA]	120						
Rated current	I_n [A] ¹⁾	35	50	63	80	100	125	160
Circuit breaker type: 5SP4...-.	40	---	0.8	1	1.5	2.8	4.2	6.8
	50	---	---	0.9	1.5	2.8	3.7	5.2
Characteristic B/C	63	---	---	---	1.1	2	2.8	4.4
I_{cn} [kA] = 10	80	---	---	---	---	1.6	2.2	3.4
	100	---	---	---	---	---	2	3.1
	125	---	---	---	---	---	---	4
Circuit breaker type: 5SP4...-.	40	---	---	0.9	1.4	2.5	3.5	5.5
	50	---	---	0.9	1.4	2.6	3.6	5.5
Characteristic D	63	---	---	---	1	1.5	2.2	3.9
I_{cn} [kA] = 10	80	---	---	---	---	---	---	2.9
	100	---	---	---	---	---	---	2.6

¹⁾ In 240/415 V, 50 Hz systems, the selectivity limits are reduced by 10 %.
The selectivity limits for adjustable releases apply to the maximum value,
 I_n = rated current. I_t $\hat{=}$ tripping current.

Selectivity limit values of miniature circuit breakers/fuses in kA

		Selectivity of the 5SP4... for the upstream fuse 3NA... [kA]													
Fuse		3NA													
Operational class		gG													
Size		0													
Rated breaking capacity	I_{cu} [AC kA]	120													
Rated current	I_n [A] ¹⁾	6	10	16	20	25	32	35	40	50	63	80	100	125	160
Circuit breaker type: 5SP4...-.	40	---	---	---	---	---	---	---	---	0.8	0.9	1.5	2.6	4.2	7
	50	---	---	---	---	---	---	---	---	---	0.8	1.4	2.7	3.6	5.3
Characteristic B/C	63	---	---	---	---	---	---	---	---	---	---	1.1	1.9	2.8	4.5
I_{cn} [kA] = 10	80	---	---	---	---	---	---	---	---	---	---	---	1.5	2.2	3.5
	100	---	---	---	---	---	---	---	---	---	---	---	---	2	3.2
	125	---	---	---	---	---	---	---	---	---	---	---	---	---	4.1
Circuit breaker type: 5SP4...-.	40	---	---	---	---	---	---	---	---	---	0.9	1.4	2.4	3.5	5.7
	50	---	---	---	---	---	---	---	---	---	---	1.3	2.5	3.6	5.6
Characteristic D	63	---	---	---	---	---	---	---	---	---	---	1	1.5	2.2	4
I_{cn} [kA] = 10	80	---	---	---	---	---	---	---	---	---	---	---	---	---	3
	100	---	---	---	---	---	---	---	---	---	---	---	---	---	2.6

¹⁾ In 240/415 V, 50 Hz systems, the selectivity limits are reduced by 10 %.
The selectivity limits for adjustable releases apply to the maximum value,
 I_n = rated current. I_t $\hat{=}$ tripping current.

Miniature Circuit Breakers

Configuration and dimensioning

Selectivity limit values of miniature circuit breakers/fuses in kA

		Selectivity of the 5SP4... for the upstream fuse 3NA... [kA]													
Fuse		3NA													
Operational class		gG													
Size		1													
Rated breaking capacity	I_{cu} [AC kA]	120													
Rated current	I_n [A] ¹⁾	16	20	25	35	40	50	63	80	100	125	160	200	224	250
Circuit breaker type: 5SP4...-	40	---	---	---	---	---	0.8	0.9	1.5	2.6	4.2	7	T	T	T
	50	---	---	---	---	---	---	0.8	1.4	2.7	3.6	5.3	9.8	T	T
Characteristic B/C	63	---	---	---	---	---	---	---	1.1	1.9	2.8	4.5	9	T	T
I_{cn} [kA] = 10	80	---	---	---	---	---	---	---	---	1.5	2.2	3.5	6.6	7.5	T
	100	---	---	---	---	---	---	---	---	---	2	3.2	5.6	6.7	8.8
	125	---	---	---	---	---	---	---	---	---	---	4.1	7.4	9.1	T
Circuit breaker type: 5SP4...-	40	---	---	---	---	---	---	0.9	1.4	2.4	3.5	5.7	9.5	T	T
	50	---	---	---	---	---	---	---	1.3	2.5	3.6	5.6	9.7	T	T
Characteristic D	63	---	---	---	---	---	---	---	1	1.5	2.2	4	6.9	8.2	T
I_{cn} [kA] = 10	80	---	---	---	---	---	---	---	---	---	---	3	5.6	6.7	8.8
	100	---	---	---	---	---	---	---	---	---	---	2.6	5.3	6.4	8.2

T $\hat{=}$ full selectivity up to I_{cu}/I_{cn} rated short-circuit breaking capacity of the downstream protective device.

- ¹⁾ In 240/415 V, 50 Hz systems, the selectivity limits are reduced by 10 %.
The selectivity limits for adjustable releases apply to the maximum value,
 I_n = rated current. I_t $\hat{=}$ tripping current.

Selectivity limit values of miniature circuit breakers/fuses in kA

		Selectivity of the 5SP4... for the upstream fuse 3NA... [kA]													
Fuse		3NA													
Operational class		gG													
Size		2													
Rated breaking capacity	I_{cu} [AC kA]	120													
Rated current	I_n [A] ¹⁾	35	50	63	80	100	125	160	200	224	250	300	315	355	400
Circuit breaker type: 5SP4...-	40	---	0.8	0.9	1.5	2.6	4.1	6.9	T	T	T	T	T	T	T
	50	---	---	0.9	1.4	2.6	3.6	5.3	9.8	T	T	T	T	T	T
Characteristic B/C	63	---	---	---	1.1	1.8	2.8	4.5	9	T	T	T	T	T	T
I_{cn} [kA] = 10	80	---	---	---	---	1.5	2.1	3.5	6.6	7.5	T	T	T	T	T
	100	---	---	---	---	---	2	3.2	5.6	6.7	8.8	T	T	T	T
	125	---	---	---	---	---	---	4.1	7.4	9.1	T	T	T	T	T
Circuit breaker type: 5SP4...-	40	---	---	0.9	1.4	2.3	3.4	5.7	9.5	T	T	T	T	T	T
	50	---	---	---	1.3	2.4	3.6	5.6	9.7	T	T	T	T	T	T
Characteristic D	63	---	---	---	1	1.5	2.1	4	6.9	8.2	T	T	T	T	T
I_{cn} [kA] = 10	80	---	---	---	---	---	---	3	5.6	6.7	8.8	T	T	T	T
	100	---	---	---	---	---	---	2.6	5.3	6.4	8.2	T	T	T	T

T $\hat{=}$ full selectivity up to I_{cu}/I_{cn} rated short-circuit breaking capacity of the downstream protective device.

- ¹⁾ In 240/415 V, 50 Hz systems, the selectivity limits are reduced by 10 %.
The selectivity limits for adjustable releases apply to the maximum value,
 I_n = rated current. I_t $\hat{=}$ tripping current.

Selectivity limit values of miniature circuit breakers/fuses in kA

		Selectivity of the 5SP4... for the upstream fuse 3NA... [kA]									
Fuse		3NA									
Operational class		gG									
Size		3									
Rated breaking capacity	I_{cu} [AC kA]	120									
Rated current	I_n [A] ¹⁾	200	224	250	300	315	355	400	425	500	630
Circuit breaker type:		T	T	T	T	T	T	T	T	T	T
5SP4...-.	40	9	T	T	T	T	T	T	T	T	T
Characteristic B/C	63	7.6	T	T	T	T	T	T	T	T	T
I_{cn} [kA] = 10	80	6.3	7.3	T	T	T	T	T	T	T	T
	100	5.2	6.5	9	T	T	T	T	T	T	T
	125	6.8	8.8	T	T	T	T	T	T	T	T
Circuit breaker type:		T	T	T	T	T	T	T	T	T	T
5SP4...-.	40	8.8	T	T	T	T	T	T	T	T	T
Characteristic D	50	9	T	T	T	T	T	T	T	T	T
I_{cn} [kA] = 10	63	6.5	7.9	T	T	T	T	T	T	T	T
	80	5.2	6.5	9	T	T	T	T	T	T	T
	100	4.7	6.3	8.6	T	T	T	T	T	T	T

T $\hat{=}$ full selectivity up to I_{cu}/I_{cn} rated short-circuit breaking capacity of the downstream protective device.

- ¹⁾ In 240/415 V, 50 Hz systems, the selectivity limits are reduced by 10 %.
The selectivity limits for adjustable releases apply to the maximum value,
 I_n = rated current. I_t $\hat{=}$ tripping current.

Selectivity limit values of miniature circuit breakers/fuses in kA

		Selectivity of the 5SP4... for the upstream fuse 3NA... [kA]									
Fuse		3NA									
Operational class		gG									
Size		4					4a				
Rated breaking capacity	I_{cu} [AC kA]	120									
Rated current	I_n [A] ¹⁾	630	800	1000	1250	500	630	800	1000	1250	
Circuit breaker type:		T	T	T	T	T	T	T	T	T	
5SP4...-.	40	T	T	T	T	T	T	T	T	T	
Characteristic B/C	50	T	T	T	T	T	T	T	T	T	
I_{cn} [kA] = 10	63	T	T	T	T	T	T	T	T	T	
	80	T	T	T	T	T	T	T	T	T	
	100	T	T	T	T	T	T	T	T	T	
	125	T	T	T	T	T	T	T	T	T	
Circuit breaker type:		T	T	T	T	T	T	T	T	T	
5SP4...-.	40	T	T	T	T	T	T	T	T	T	
Characteristic D	50	T	T	T	T	T	T	T	T	T	
I_{cn} [kA] = 10	63	T	T	T	T	T	T	T	T	T	
	80	T	T	T	T	T	T	T	T	T	
	100	T	T	T	T	T	T	T	T	T	

T $\hat{=}$ full selectivity up to I_{cu}/I_{cn} rated short-circuit breaking capacity of the downstream protective device.

- ¹⁾ In 240/415 V, 50 Hz systems, the selectivity limits are reduced by 10 %.
The selectivity limits for adjustable releases apply to the maximum value,
 I_n = rated current. I_t $\hat{=}$ tripping current.

Miniature Circuit Breakers

Configuration and dimensioning

Selectivity limit values of miniature circuit breakers/fuses in kA

Fuse		Selectivity of the 5SL4... for the upstream fuse 5SB/5SC/5SD... [kA]														
		5SB2				5SB4				5SC2			5SD8			
Releases		gG														
Rated breaking capacity		50														
Rated current		I_n [A] ¹⁾														
		16	20	25	32	35	50	63	80	100	16	20	25	35	50	63
Circuit breaker type: 5SL4...-																
Characteristic B																
I_{cn} [kA] = 10																
1		T	T	T	T	T	T	T	T	T	T	T	T	T	T	
2		0.6	1	3.3	T	T	T	T	T	0.9	1.3	2.1	T	T	T	
3		0.45	0.6	1.2	2.9	T	T	T	T	0.55	0.7	0.9	5.2	T	T	
4		0.35	0.5	0.85	1.4	2.1	3.8	T	T	0.4	0.5	0.65	1.8	3.9	T	
6		0.35	0.5	0.8	1.3	1.9	3.1	6.7	T	0.4	0.5	0.6	1.6	3.1	6.3	
8		---	0.45	0.75	1.2	1.7	2.6	5	6.2	---	0.5	0.6	1.4	2.7	4.7	
10		---	0.45	0.7	1	1.5	2.2	4	4.9	---	0.45	0.55	1.2	2.2	3.8	
13		---	0.4	0.65	1	1.4	2.1	3.5	4.2	8.4	---	0.45	0.5	1.2	3.4	
16		---	0.4	0.6	0.9	1.2	1.9	3.1	3.8	7.2	---	0.4	0.5	1	3	
20		---	---	0.6	0.9	1.2	1.8	2.9	3.5	6.6	---	---	0.5	1	2.8	
25		---	---	---	0.85	1.1	1.6	2.7	3.2	5.7	---	---	---	0.9	2.5	
32		---	---	---	---	---	1.4	2.3	2.8	4.9	---	---	---	1.4	2.2	
40		---	---	---	---	---	1.4	2.3	2.8	4.9	---	---	---	1.4	2.2	
50		---	---	---	---	---	---	1.9	2.3	3.9	---	---	---	---	1.8	
63		---	---	---	---	---	---	---	2.3	3.6	---	---	---	---	---	
Circuit breaker type: 5SL4...-																
Characteristic C																
I_{cn} [kA] = 10																
0.3		T	T	T	T	T	T	T	T	T	T	T	T	T	T	
0.5		T	T	T	T	T	T	T	T	T	T	T	T	T	T	
1		0.8	1.6	8.3	T	T	T	T	T	1.3	2.2	3.7	T	T	T	
1.6		0.5	0.75	1.6	5.1	T	T	T	T	0.65	0.85	1.1	T	T	T	
2		0.4	0.55	1	1.8	2.9	5.9	T	T	0.45	0.6	0.75	2.4	6.1	T	
3		0.35	0.5	0.85	1.4	2.2	3.7	8.5	T	0.4	0.55	0.65	1.9	3.8	8	
4		---	0.5	0.8	1.3	1.9	3.1	6.1	7.9	0.4	0.5	0.6	1.6	3.1	5.8	
6		---	0.45	0.7	1	1.4	2.3	4.2	5.3	0.35	0.45	0.55	1.2	2.3	4	
8		---	---	0.55	0.85	1.1	1.7	3	3.7	8	---	0.4	0.45	0.9	2.8	
10		---	---	0.55	0.85	1.1	1.7	3	3.7	8	---	0.4	0.45	0.9	2.8	
13		---	---	0.55	0.85	1.1	1.6	2.5	3.1	5.8	---	0.4	0.45	0.9	2.4	
16		---	---	0.55	0.85	1.1	1.6	2.5	3.1	5.8	---	0.4	0.45	0.9	2.4	
20		---	---	0.5	0.8	1	1.4	2.3	2.8	5.1	---	---	0.45	0.85	2.1	
25		---	---	---	0.8	1	1.4	2.3	2.8	5.1	---	---	---	0.85	2.1	
32		---	---	---	---	---	1.3	2.1	2.5	4.4	---	---	---	1.3	1.9	
40		---	---	---	---	---	1.3	2.1	2.5	4.4	---	---	---	1.3	1.9	
50		---	---	---	---	---	---	1.8	2.2	3.5	---	---	---	---	1.7	
63		---	---	---	---	---	---	---	2.2	3.5	---	---	---	---	---	
Circuit breaker type: 5SL4...-																
Characteristic D																
I_{cn} [kA] = 10																
0.3		T	T	T	T	T	T	T	T	T	T	T	T	T	T	
0.5		T	T	T	T	T	T	T	T	T	T	T	T	T	T	
1		0.55	0.85	2	7.8	T	T	T	T	0.7	1	1.3	T	T	T	
1.6		0.45	0.6	1.1	2	3.5	9.1	T	T	0.55	0.7	0.85	2.8	T	T	
2		0.4	0.55	0.9	1.6	2.5	4.4	T	T	0.45	0.55	0.7	2.1	4.5	T	
3		---	0.45	0.8	1.3	2	3.2	6.6	8.4	0.4	0.5	0.6	1.6	3.3	6.2	
4		---	0.45	0.7	1.1	1.6	2.6	5	6.4	0.35	0.45	0.55	1.3	2.6	4.7	
6		---	0.4	0.65	1	1.3	2.1	3.7	4.6	T	---	0.4	0.5	1.1	3.6	
8		---	---	0.55	0.85	1.1	1.6	2.6	3.2	6	---	---	0.45	0.9	2.5	
10		---	---	0.55	0.85	1.1	1.6	2.6	3.2	6	---	---	0.45	0.9	2.5	
13		---	---	0.5	0.75	1	1.4	2.3	2.8	5	---	---	0.45	0.8	2.1	
16		---	---	0.5	0.75	1	1.4	2.3	2.8	5	---	---	0.45	0.8	2.1	
20		---	---	0.45	0.75	0.9	1.4	2.2	2.7	4.7	---	---	0.4	0.8	2	
25		---	---	---	0.75	0.9	1.4	2.2	2.7	4.7	---	---	---	0.8	2	
32		---	---	---	---	---	1.2	1.9	2.4	4.1	---	---	---	1.2	1.8	
40		---	---	---	---	---	1.2	1.9	2.4	4.1	---	---	---	1.2	1.8	
50		---	---	---	---	---	---	1.6	2	3.1	---	---	---	---	1.5	
63		---	---	---	---	---	---	---	2	3.1	---	---	---	---	---	

T ≙ full selectivity up to I_{cu}/I_{cn} rated short-circuit breaking capacity of the downstream protective device.

¹⁾ In 240/415 V, 50 Hz systems, the selectivity limits are reduced by 10%.
The selectivity limits for adjustable releases apply to the maximum value,
 I_n = rated current. I_t ≙ tripping current.

Selectivity limit values of miniature circuit breakers/fuses in kA

Fuse	Releases	Rated breaking capacity I_{cu} [A]	Rated current I_n [A] ¹⁾	Selectivity of the 5SL4... for the upstream fuse 5SE2/5SA2... [kA]									5SA2 Delayed 40			
				5SE2 gG									16	20	25	
				16	20	25	32	35	40	50	63	80	100	16	20	25
Circuit breaker type:	5SL4...-	1		T	T	T	T	T	T	T	T	T	T	T	T	T
		2		0.5	1.2	3	T	T	T	T	T	T	T	0.7	1.1	3.7
	Characteristic B	3		0.35	0.65	1.1	3.5	5.6	T	T	T	T	T	0.5	0.65	1.3
	I_{cn} [kA] = 10	4		---	0.5	0.75	1.5	1.8	2.6	4.7	T	T	T	0.4	0.5	0.85
		6		---	0.5	0.7	1.4	1.6	2.2	3.6	6	T	T	0.4	0.5	0.8
		8		---	0.5	0.7	1.3	1.5	2	3	4.6	6.3	T	0.35	0.5	0.75
		10		---	0.45	0.65	1.1	1.3	1.7	2.5	3.7	4.9	9.4	0.35	0.45	0.7
		13		---	0.4	0.6	1.1	1.2	1.6	2.3	3.3	4.2	7.1	---	0.45	0.7
		16		---	0.4	0.55	1	1.1	1.5	2.1	2.9	3.7	6.2	---	0.4	0.65
		20		---	---	0.5	0.9	1.1	1.4	2	2.7	3.5	5.6	---	---	0.6
		25		---	---	---	0.9	1	1.3	1.8	2.5	3.1	4.9	---	---	---
		32		---	---	---	---	---	1.2	1.6	2.2	2.7	4.3	---	---	---
		40		---	---	---	---	---	---	1.6	2.2	2.7	4.3	---	---	---
		50		---	---	---	---	---	---	---	1.8	2.3	3.5	---	---	---
		63		---	---	---	---	---	---	---	---	2.2	2.4	---	---	---
Circuit breaker type:	5SL4...-	0.3		T	T	T	T	T	T	T	T	T	T	T	T	T
		0.5		T	T	T	T	T	T	T	T	T	T	T	T	T
	Characteristic C	1		0.7	1.9	6	T	T	T	T	T	T	T	0.9	1.7	T
	I_{cn} [kA] = 10	1.6		0.45	0.8	1.4	7.5	T	T	T	T	T	T	0.55	0.75	1.7
		2		---	0.55	0.9	2	2.4	3.6	8.5	T	T	T	0.45	0.6	1
		3		---	0.5	0.8	1.6	1.9	2.7	4.4	7.8	T	T	0.4	0.55	0.9
		4		---	0.5	0.75	1.4	1.6	2.2	3.6	5.6	8	T	0.4	0.5	0.85
		6		---	0.45	0.65	1.1	1.3	1.7	2.5	3.9	5.3	T	---	0.45	0.7
		8		---	---	0.5	0.9	1	1.4	1.9	2.7	3.6	6.6	---	---	0.55
		10		---	---	0.5	0.9	1	1.4	1.9	2.7	3.6	6.6	---	---	0.55
		13		---	---	0.5	0.9	1	1.3	1.7	2.4	3	4.9	---	---	0.55
		16		---	---	0.5	0.9	1	1.3	1.7	2.4	3	4.9	---	---	0.55
		20		---	---	0.5	0.85	0.9	1.2	1.6	2.1	2.7	4.3	---	---	0.55
		25		---	---	---	0.85	0.9	1.2	1.6	2.1	2.7	4.3	---	---	---
		32		---	---	---	---	---	1.1	1.4	1.9	2.4	3.8	---	---	---
		40		---	---	---	---	---	---	1.4	1.9	2.4	3.8	---	---	---
		50		---	---	---	---	---	---	---	1.7	2.1	3.2	---	---	---
		63		---	---	---	---	---	---	---	---	2.1	3.2	---	---	---
Circuit breaker type:	5SL4...-	0.3		T	T	T	T	T	T	T	T	T	T	T	T	T
		0.5		T	T	T	T	T	T	T	T	T	T	T	T	T
	Characteristic D	1		0.5	0.9	1.8	T	T	T	T	T	T	T	0.65	0.85	2.1
	I_{cn} [kA] = 10	1.6		0.35	0.65	1	2.3	2.9	4.6	T	T	T	T	0.5	0.65	1.1
		2		---	0.55	0.85	1.7	2.1	3.1	5.4	T	T	T	0.45	0.55	0.9
		3		---	0.45	0.7	1.4	1.7	2.3	3.8	6	8.5	T	0.35	0.5	0.8
		4		---	0.45	0.65	1.2	1.4	1.9	3	4.7	6.3	T	0.35	0.45	0.75
		6		---	0.4	0.6	1	1.2	1.6	2.4	3.5	4.6	8.9	---	0.4	0.65
		8		---	---	0.45	0.85	1	1.3	1.7	2.4	3.1	5	---	---	0.5
		10		---	---	0.45	0.85	1	1.3	1.7	2.4	3.1	5	---	---	0.5
		13		---	---	0.45	0.8	0.9	1.2	1.5	2.1	2.7	4.3	---	---	0.5
		16		---	---	0.45	0.8	0.9	1.2	1.5	2.1	2.7	4.3	---	---	0.5
		20		---	---	---	0.75	0.9	1.1	1.5	2	2.6	4.1	---	---	0.5
		25		---	---	---	0.75	0.9	1.1	1.5	2	2.6	4.1	---	---	---
		32		---	---	---	---	---	1	1.3	1.8	2.3	3.6	---	---	---
		40		---	---	---	---	---	---	1.3	1.8	2.3	3.6	---	---	---
		50		---	---	---	---	---	---	---	1.5	1.9	2.9	---	---	---
		63		---	---	---	---	---	---	---	---	1.9	2.9	---	---	---

T $\hat{=}$ full selectivity up to I_{cu}/I_{cn} rated short-circuit breaking capacity of the downstream protective device.

¹⁾ In 240/415 V, 50 Hz systems, the selectivity limits are reduced by 10 %.
The selectivity limits for adjustable releases apply to the maximum value,
 I_n = rated current. I_t $\hat{=}$ tripping current.

Miniature Circuit Breakers

Configuration and dimensioning

Selectivity of miniature circuit breakers/circuit breakers

Distribution systems can also be set up without fuses. In such cases, a circuit breaker acts as an upstream protective device. In this case, the selectivity limit depends on the level of peak current \hat{I} let through by the miniature circuit breaker and the tripping current of the circuit breaker.

The following tables show the short-circuit current in kA up to which selectivity is guaranteed between miniature circuit breakers and upstream circuit breakers according to IEC/EN 60947-2 at 230/400 V AC, 50 Hz.

Selectivity limit values of miniature circuit breakers/circuit breakers in kA

Downstream miniature circuit breakers			Upstream circuit breakers								
I_n [A] ¹⁾	I_n [A]	I_t [A]	3RV1.1			3RV1.2					
	I_{cu} [kA]	I_{cn} [kA]	10	12	8	10	12.5	16	20	22	25
			120	144	96	120	150	192	240	264	300
			50	50	100	100	100	50	50	50	50
			Selectivity limits [kA]								
5SY4...-5											
Characteristic A	2	10	0.2	0.2	--	--	0.2	0.2	0.6	1.2	1.5
	10	10	--	--	--	--	--	--	0.3	0.5	0.5
	16	10	--	--	--	--	--	--	0.3	0.4	0.5
	32	10	--	--	--	--	--	--	--	--	--
	40	10	--	--	--	--	--	--	--	--	--
5SY6...-6, 5SY4...-6, 5SY7...-6, 5SJ4...-6HG40²⁾											
Characteristic B	6	6/10/15	0.2	0.2	--	--	0.2	0.2	0.3	0.5	0.5
	10	6/10/15	--	0.2	--	--	0.2	0.2	0.3	0.4	0.5
	13	6/10/15	--	--	--	--	--	0.2	0.2	0.4	0.4
	16	6/10/15	--	--	--	--	--	--	0.2	0.4	0.4
	20	6/10/15	--	--	--	--	--	--	--	--	0.4
	25	6/10/15	--	--	--	--	--	--	--	--	--
	32	6/10/15	--	--	--	--	--	--	--	--	--
	40	6/10/15	--	--	--	--	--	--	--	--	--
	50	6/10/15	--	--	--	--	--	--	--	--	--
	63	6/10/15	--	--	--	--	--	--	--	--	--
	80	6/10/15	--	--	--	--	--	--	--	--	--
5SY6...-7, 5SY4...-7, 5SY7...-7, 5SJ4...-7HG..²⁾											
Characteristic C	0.5	10/15	0.2	0.2	0.1	0.1	0.2	0.2	0.5	0.6	0.6
	1	10/15	0.2	0.2	0.1	0.1	0.2	0.2	0.5	0.6	0.6
	1.6	10/15	0.2	0.2	0.1	0.1	0.2	0.2	0.5	0.6	0.6
	2	10/15	0.2	0.2	0.1	0.1	0.2	0.2	0.5	0.6	0.6
	3	10/15	--	0.2	--	--	0.2	0.2	0.3	0.4	0.5
	4	10/15	--	0.2	--	--	0.2	0.2	0.3	0.4	0.5
	6	10/15	--	0.2	--	--	0.2	0.2	0.3	0.4	0.5
	8	10/15	--	0.2	--	--	0.2	0.2	0.2	0.4	0.4
	10	10/15	--	0.2	--	--	0.2	0.2	0.2	0.4	0.4
	13	10/15	--	--	--	--	--	0.2	0.2	0.4	0.4
	16	10/15	--	--	--	--	--	--	0.2	0.4	0.4
	20	10/15	--	--	--	--	--	--	--	--	0.4
	25	10/15	--	--	--	--	--	--	--	--	--
	32	10/15	--	--	--	--	--	--	--	--	--
	40	10/15	--	--	--	--	--	--	--	--	--
	50	10/15	--	--	--	--	--	--	--	--	--
	63	10/15	--	--	--	--	--	--	--	--	--
	80	10/15	--	--	--	--	--	--	--	--	--
5SY4...-8, 5SY7...-8, 5SJ4...-8HG..²⁾											
Characteristic D	2	10/15	--	--	--	--	0.2	0.2	0.4	0.6	0.6
	6	10/15	--	--	--	--	--	--	0.3	0.4	0.4
	10	10/15	--	--	--	--	--	--	0.2	0.4	0.4
	16	10/15	--	--	--	--	--	--	--	--	--
	32	10/15	--	--	--	--	--	--	--	--	--
	40	10/15	--	--	--	--	--	--	--	--	--
	50	10/15	--	--	--	--	--	--	--	--	--
	63	10/15	--	--	--	--	--	--	--	--	--

Values for 5SY8 on request.

¹⁾ In 240/415 V, 50 Hz systems, the selectivity limits are reduced by 10 %. The selectivity limits for adjustable releases apply to the maximum value, I_n = rated current, I_t ≙ tripping current.

²⁾ The values specified for 5SJ4...-HG.. are not according to UL but are the manufacturer's specifications according to EN 60947-2 and apply for voltage U_n = 230 V ~. For available rated currents, see Catalog LV 10.

In the event of a short-circuit, selectivity up to the specified values in kA exists between miniature circuit breakers and circuit breakers according to IEC/EN 60947-2.

Selectivity limit values of miniature circuit breakers/circuit breakers in kA

Downstream miniature circuit breakers			Upstream circuit breakers						
I_n [A] ¹⁾	I_{cn} [kA]	I_n [A] I_t [A] I_{cu} [kA] I_{cn} [kA]	3RV1.3						
			16	20	25	32	40	45	50
			Selectivity limits [kA]						
5SY4...-5									
Characteristic A	2	10	0.2	0.8	1.2	2.5	3	6	6
	10	10	0.2	0.4	0.5	0.6	0.8	1	1.2
	16	10	--	0.3	0.4	0.6	0.8	0.8	1
	32	10	--	--	--	--	0.6	0.8	0.8
	40	10	--	--	--	--	--	--	0.8
5SY6...-6, 5SY4...-6, 5SY7...-6, 5SJ4...-6HG40²⁾									
Characteristic B	6	6/10/15	0.2	0.3	0.5	0.6	0.8	1	1.2
	10	6/10/15	0.2	0.3	0.4	0.6	0.8	1	1.2
	13	6/10/15	0.2	0.3	0.4	0.6	0.8	1	1
	16	6/10/15	--	0.3	0.4	0.6	0.8	1	1
	20	6/10/15	--	--	0.4	0.6	0.8	1	1
	25	6/10/15	--	--	--	0.5	0.6	0.8	0.8
	32	6/10/15	--	--	--	--	0.6	0.8	0.8
	40	6/10/15	--	--	--	--	--	--	0.8
	50	6/10/15	--	--	--	--	--	--	--
	63	6/10/15	--	--	--	--	--	--	--
80	6/10/15	--	--	--	--	--	--	--	
5SY6...-7, 5SY4...-7, 5SY7...-7, 5SJ4...-7HG..²⁾									
Characteristic C	0.5	6/10/15	0.3	0.5	0.6	1	1	1.5	3
	1	6/10/15	0.3	0.5	0.6	1	1	1.5	3
	1.6	6/10/15	0.3	0.5	0.6	1	1	1.5	3
	2	6/10/15	0.3	0.5	0.6	1	1	1.5	3
	3	6/10/15	0.2	0.3	0.4	0.6	0.8	1	1
	4	6/10/15	0.2	0.3	0.4	0.6	0.8	1	1
	6	6/10/15	0.2	0.3	0.4	0.6	0.8	1	1
	8	6/10/15	0.2	0.2	0.4	0.6	0.6	0.8	1
	10	6/10/15	0.2	0.2	0.4	0.6	0.6	0.8	1
	13	6/10/15	0.2	0.2	0.4	0.6	0.6	0.8	1
	16	6/10/15	--	0.2	0.4	0.6	0.6	0.8	1
	20	6/10/15	--	--	0.4	0.6	0.6	0.8	1
	25	6/10/15	--	--	--	0.5	0.6	0.8	0.8
	32	6/10/15	--	--	--	--	0.6	0.8	0.8
	40	6/10/15	--	--	--	--	--	--	0.8
50	6/10/15	--	--	--	--	--	--	--	
63	6/10/15	--	--	--	--	--	--	--	
80	6/10/15	--	--	--	--	--	--	--	
5SY4...-8, 5SY7...-8, 5SJ4...-8HG..²⁾									
Characteristic D	2	10/15	0.3	0.5	0.6	0.8	1.2	1.5	1.5
	6	10/15	0.2	0.3	0.4	0.6	0.8	1	1
	10	10/15	--	0.3	0.4	0.5	0.6	0.8	0.8
	16	10/15	--	--	--	0.5	0.6	0.6	0.8
	32	10/15	--	--	--	--	--	0.6	0.6
	40	10/15	--	--	--	--	--	--	--
	50	10/15	--	--	--	--	--	--	--
63	10/15	--	--	--	--	--	--	--	

T ≙ full selectivity up to rated breaking capacity I_{cn} of the downstream protective device.

1) In 240/415 V, 50 Hz systems, the selectivity limits are reduced by 10 %.
The selectivity limits for adjustable releases apply to the maximum value,
 I_n = rated current. I_t ≙ tripping current.

2) The values specified for 5SJ4...-HG.. are not according to UL but are the manufacturer's specifications according to EN 60947-2 and apply for voltage $U_g = 230$ V ~. For available rated currents, see Catalog LV 10.

Miniature Circuit Breakers

Configuration and dimensioning

In the event of a short-circuit, selectivity up to the specified values in kA exists between miniature circuit breakers and circuit breakers according to IEC/EN 60947-2.

Selectivity limit values of miniature circuit breakers/circuit breakers in kA

Downstream miniature circuit breakers			Upstream circuit breakers									
	I_n [A] ¹⁾	I_{cn} [kA]	3RV1.4									
			16	20	25	32	40	50	63	75	90	100
			I_n [A]	I_t [A]	I_{cu} [kA]	I_{cn} [kA]	Selectivity limits [kA]					
5SY4...-5												
Characteristic A	2	10	0.5	0.8	1.5	2.5	3	T	T	T	T	T
	10	10	0.3	0.4	0.5	0.6	0.8	1.2	1.5	2.5	3	4
	16	10	--	0.3	0.5	0.6	0.6	1	1.5	2	3	3
	32	10	--	--	--	--	0.6	0.8	1.5	2	2.5	3
	40	10	--	--	--	--	--	0.8	1.2	1.5	2	2
5SY6...-6, 5SY4...-6, 5SY7...-6, 5SJ4...-6HG40²⁾												
Characteristic B	6	6/10/15	0.2	0.4	0.5	0.6	0.8	1.2	2	3	T	T
	10	6/10/15	0.2	0.3	0.5	0.6	0.8	1	1.5	2.5	4	4
	13	6/10/15	0.2	0.3	0.5	0.6	0.8	1	1.5	2	3	3
	16	6/10/15	--	0.3	0.5	0.6	0.8	1	1.5	2	3	3
	20	6/10/15	--	--	0.5	0.6	0.8	1	1.5	2	3	3
	25	6/10/15	--	--	--	0.5	0.8	0.8	1.5	2	3	3
	32	6/10/15	--	--	--	--	0.6	0.8	1.5	2	3	3
	40	6/10/15	--	--	--	--	0.6	0.8	1.2	1.5	2.5	2.5
	50	6/10/15	--	--	--	--	--	--	1.2	1.5	2.5	2.5
	63	6/10/15	--	--	--	--	--	--	1.2	1.5	2.5	2.5
5SY6...-7, 5SY4...-7, 5SY7...-7, 5SJ4...-7HG...²⁾												
Characteristic C	0.5	6/10/15	0.4	0.6	0.8	0.8	1	3	T	T	T	T
	1	6/10/15	0.4	0.6	0.8	0.8	1	3	T	T	T	T
	1.6	6/10/15	0.4	0.6	0.8	0.8	1	3	T	T	T	T
	2	6/10/15	0.4	0.6	0.8	0.8	1	3	T	T	T	T
	3	6/10/15	0.2	0.3	0.5	0.6	0.8	1	2	2.5	5	5
	4	6/10/15	0.2	0.3	0.5	0.6	0.8	1	2	2.5	5	5
	6	6/10/15	0.2	0.3	0.5	0.6	0.8	1	2	2.5	5	5
	8	6/10/15	0.2	0.3	0.4	0.6	0.6	1	1.5	2	3	3
	10	6/10/15	0.2	0.3	0.4	0.6	0.6	1	1.5	2	3	3
	13	6/10/15	0.2	0.3	0.4	0.6	0.6	1	1.5	2	3	3
	16	6/10/15	--	0.3	0.4	0.6	0.6	1	1.5	2	3	3
	20	6/10/15	--	--	0.4	0.6	0.6	1	1.5	2	3	3
	25	6/10/15	--	--	--	0.5	0.6	0.8	1.2	1.5	2.5	2.5
	32	6/10/15	--	--	--	--	0.6	0.8	1.2	1.5	2.5	2.5
	40	6/10/15	--	--	--	--	--	0.6	1	1.5	2	2
50	6/10/15	--	--	--	--	--	--	1	1.2	1.5	2	
63	6/10/15	--	--	--	--	--	--	--	--	1.5	1.5	
5SY4...-8, 5SY7...-8, 5SJ4...-8HG...²⁾												
Characteristic D	2	10/15	0.4	0.5	0.6	0.8	1	1.5	3	4	T	T
	6	10/15	0.2	0.3	0.4	0.6	0.6	1	1.5	2.5	3	3
	10	10/15	--	0.3	0.4	0.5	0.6	0.8	1.5	2	3	3
	16	10/15	--	--	--	0.5	0.6	0.8	1.2	1.5	2.5	2.5
	32	10/15	--	--	--	--	--	0.6	1	1.5	2	2
	40	10/15	--	--	--	--	--	--	1	1.2	1.5	1.5
50	10/15	--	--	--	--	--	--	1	1.2	1.5	1.5	
5SP4...-7												
Characteristic C	80	10	--	--	--	--	--	--	--	--	--	1.2
	100	10	--	--	--	--	--	--	--	--	--	--
5SP4...-8												
Characteristic D	80	10	--	--	--	--	--	--	--	--	--	--
	100	10	--	--	--	--	--	--	--	--	--	--

Values for 5SY8 on request.

T $\hat{=}$ full selectivity up to rated breaking capacity I_{cn} of the downstream protective device.

¹⁾ In 240/415 V, 50 Hz systems, the selectivity limits are reduced by 10 %.
The selectivity limits for adjustable releases apply to the maximum value,
 I_n = rated current. I_t $\hat{=}$ tripping current.

²⁾ The values specified for 5SJ4...-HG... are not according to UL but are the manufacturer's specifications according to EN 60947-2 and apply for voltage $U_0 = 230$ V ~. For available rated currents, see Catalog LV 10.

Selectivity limit values of miniature circuit breakers/circuit breakers in kA

Downstream miniature circuit breakers			Upstream circuit breakers													
			3WN1, ETU1, adjustable													
I_n [A]	126 ... 315	160 ... 400	200 ... 500	252 ... 630	320 ... 800	400 ... 1000	500 ... 1250	640 ... 1600	800 ... 2000	1000 ... 2500	1280 ... 3200	1600 ... 4000	2000 ... 5000	2520 ... 6300		
I_{cu} [kA]	65		80	50 ... 80				50 ... 100	65 ... 100		100					
I_t [A]	630 ... 3780	800 ... 4800	1000 ... 5000	1260 ... 7560	1600 ... 9600	2000 ... 12000	2500 ... 15000	3200 ... 19200	4000 ... 24400	5000 ... 30000	6300 ... 38400	8000 ... 48000	10000 ... 60000	12600 ... 75600		
I_n [A] ¹⁾ I_{cn} [kA]	Selectivity limits [kA]															
5SL3, 5SL6																
Characteristic B/C	0.5	6	T	T	T	T	T	T	T	T	T	T	T	T	T	T
	1	6	T	T	T	T	T	T	T	T	T	T	T	T	T	T
	1.6	6	T	T	T	T	T	T	T	T	T	T	T	T	T	T
	2	6	T	T	T	T	T	T	T	T	T	T	T	T	T	T
	3	6	T	T	T	T	T	T	T	T	T	T	T	T	T	T
	4	6	T	T	T	T	T	T	T	T	T	T	T	T	T	T
	6	6	T	T	T	T	T	T	T	T	T	T	T	T	T	T
	8	6	T	T	T	T	T	T	T	T	T	T	T	T	T	T
	10	6	T	T	T	T	T	T	T	T	T	T	T	T	T	T
	13	6	T	T	T	T	T	T	T	T	T	T	T	T	T	T
	16	6	T	T	T	T	T	T	T	T	T	T	T	T	T	T
	20	6	T	T	T	T	T	T	T	T	T	T	T	T	T	T
	25	6	T	T	T	T	T	T	T	T	T	T	T	T	T	T
	32	6	T	T	T	T	T	T	T	T	T	T	T	T	T	T
	40	6	T	T	T	T	T	T	T	T	T	T	T	T	T	T
	50	6	T	T	T	T	T	T	T	T	T	T	T	T	T	T
	63	6	T	T	T	T	T	T	T	T	T	T	T	T	T	T

Downstream miniature circuit breakers			Upstream circuit breakers													
			3WN6, ETU B, adjustable													
I_n [A]	126 ... 315	160 ... 400	200 ... 500	252 ... 630	320 ... 800	400 ... 1000	500 ... 1250	640 ... 1600	800 ... 2000	1000 ... 2500	1280 ... 3200					
I_{cu} [kA]	65			65 ... 80	65		65 ... 80		80							
I_t [A]	4725	6000	7500	9450	12000	15000	18750	24000	30000	37500	48000					
I_n [A] ¹⁾ I_{cn} [kA]	Selectivity limits [kA]															
5SL3, 5SL6																
Characteristic B/C	0.5	6	T	T	T	T	T	T	T	T	T	T	T	T	T	T
	1	6	T	T	T	T	T	T	T	T	T	T	T	T	T	T
	1.6	6	T	T	T	T	T	T	T	T	T	T	T	T	T	T
	2	6	T	T	T	T	T	T	T	T	T	T	T	T	T	T
	3	6	T	T	T	T	T	T	T	T	T	T	T	T	T	T
	4	6	T	T	T	T	T	T	T	T	T	T	T	T	T	T
	6	6	T	T	T	T	T	T	T	T	T	T	T	T	T	T
	8	6	T	T	T	T	T	T	T	T	T	T	T	T	T	T
	10	6	T	T	T	T	T	T	T	T	T	T	T	T	T	T
	13	6	T	T	T	T	T	T	T	T	T	T	T	T	T	T
	16	6	T	T	T	T	T	T	T	T	T	T	T	T	T	T
	20	6	T	T	T	T	T	T	T	T	T	T	T	T	T	T
	25	6	T	T	T	T	T	T	T	T	T	T	T	T	T	T
	32	6	T	T	T	T	T	T	T	T	T	T	T	T	T	T
	40	6	T	T	T	T	T	T	T	T	T	T	T	T	T	T
	50	6	T	T	T	T	T	T	T	T	T	T	T	T	T	T
	63	6	T	T	T	T	T	T	T	T	T	T	T	T	T	T

T $\hat{=}$ full selectivity up to rated breaking capacity I_{cn} of the downstream protective device.

¹⁾ In 240/415 V, 50 Hz systems, the selectivity limits are reduced by 10 %.
The selectivity limits for adjustable releases apply to the maximum value,
 I_n = rated current. I_t $\hat{=}$ tripping current.

Miniature Circuit Breakers

Configuration and dimensioning

Selectivity limit values of miniature circuit breakers/circuit breakers in kA

Downstream miniature circuit breakers			Upstream circuit breakers														
			3WL1-3B, ETU 15B, adjustable						3WL1-4B, ETU 15B, adjustable								
I_n [A]	315 ... 630	400 ... 800	500 ... 1000	625 ... 1250	800 ... 1600	400 ... 800	500 ... 1000	625 ... 1250	800 ... 1600	1000 ... 2000	1250 ... 2500	1600 ... 3200					
I_{cu} [kA]	55 ... 150						55 ... 150							55 ... 100		80 ... 100	
I_f [A]	1260 ... 5040	1600 ... 6400	2000 ... 8000	2500 ... 10000	3200 ... 12800	1600 ... 6400	2000 ... 8000	2500 ... 10000	3200 ... 12800	4000 ... 16000	5000 ... 20000	6400 ... 25600					
I_n [A] ¹⁾ I_{cn} [kA]	Selectivity limits [kA]																
5SL3, 5SL6																	
Characteristic B/C	0.5	6	T	T	T	T	T	T	T	T	T	T	T	T	T		
	1	6	T	T	T	T	T	T	T	T	T	T	T	T	T		
	1.6	6	T	T	T	T	T	T	T	T	T	T	T	T	T		
	2	6	T	T	T	T	T	T	T	T	T	T	T	T	T		
	3	6	T	T	T	T	T	T	T	T	T	T	T	T	T		
	4	6	T	T	T	T	T	T	T	T	T	T	T	T	T		
	6	6	T	T	T	T	T	T	T	T	T	T	T	T	T		
	8	6	T	T	T	T	T	T	T	T	T	T	T	T	T		
	10	6	T	T	T	T	T	T	T	T	T	T	T	T	T		
	13	6	T	T	T	T	T	T	T	T	T	T	T	T	T		
	16	6	T	T	T	T	T	T	T	T	T	T	T	T	T		
	20	6	T	T	T	T	T	T	T	T	T	T	T	T	T		
	25	6	T	T	T	T	T	T	T	T	T	T	T	T	T		
	32	6	T	T	T	T	T	T	T	T	T	T	T	T	T		
	40	6	T	T	T	T	T	T	T	T	T	T	T	T	T		
	50	6	T	T	T	T	T	T	T	T	T	T	T	T	T		
	63	6	T	T	T	T	T	T	T	T	T	T	T	T	T		

Downstream miniature circuit breakers			Upstream circuit breakers														
			3WL1, ETU 25B, 27B, 45B, 76B, adjustable														
I_n [A]	100 ... 250	126 ... 315	160 ... 400	200 ... 500	250 ... 630	320 ... 800	400 ... 1000	500 ... 1250	640 ... 1600	800 ... 2000	1000 ... 2500	1280 ... 3200	1600 ... 4000	2000 ... 5000	2520 ... 6300		
I_{cu} [kA]	55 ... 100																
I_f [A]	5000	6300	8000	10000	12600	16000	20000	25000	32000	40000	50000	50000	50000	50000	50000		
I_n [A] ¹⁾ I_{cn} [kA]	Selectivity limits [kA]																
5SL3, 5SL6																	
Characteristic B/C	0.5	6	T	T	T	T	T	T	T	T	T	T	T	T	T		
	1	6	T	T	T	T	T	T	T	T	T	T	T	T	T		
	1.6	6	T	T	T	T	T	T	T	T	T	T	T	T	T		
	2	6	T	T	T	T	T	T	T	T	T	T	T	T	T		
	3	6	T	T	T	T	T	T	T	T	T	T	T	T	T		
	4	6	T	T	T	T	T	T	T	T	T	T	T	T	T		
	6	6	T	T	T	T	T	T	T	T	T	T	T	T	T		
	8	6	T	T	T	T	T	T	T	T	T	T	T	T	T		
	10	6	T	T	T	T	T	T	T	T	T	T	T	T	T		
	13	6	T	T	T	T	T	T	T	T	T	T	T	T	T		
	16	6	T	T	T	T	T	T	T	T	T	T	T	T	T		
	20	6	T	T	T	T	T	T	T	T	T	T	T	T	T		
	25	6	T	T	T	T	T	T	T	T	T	T	T	T	T		
	32	6	T	T	T	T	T	T	T	T	T	T	T	T	T		
	40	6	T	T	T	T	T	T	T	T	T	T	T	T	T		
	50	6	T	T	T	T	T	T	T	T	T	T	T	T	T		
	63	6	T	T	T	T	T	T	T	T	T	T	T	T	T		

T ≙ full selectivity up to rated breaking capacity I_{cn} of the downstream protective device.

- ¹⁾ In 240/415 V, 50 Hz systems, the selectivity limits are reduced by 10 %.
The selectivity limits for adjustable releases apply to the maximum value,
 I_n = rated current. I_f ≙ tripping current.

Selectivity limit values of miniature circuit breakers/circuit breakers in kA

		Selectivity of the 5SL4... for the upstream fuse 3WL1... [kA]
Circuit breakers		3WL1
Releases		ETU
Rated current	I_n [A] ¹⁾	250 A ... 6300 A
Circuit breaker type:	1	T
5SL4...-.	2	T
Characteristic B	3	T
I_{cn} [kA] = 10	4	T
	6	T
	8	T
	10	T
	13	T
	16	T
	20	T
	25	T
	32	T
	40	T
	50	T
	63	T
Circuit breaker type:	0.3	T
5SL4...-.	0.5	T
Characteristic C/D	1	T
I_{cn} [kA] = 10	1.6	T
	2	T
	3	T
	4	T
	6	T
	8	T
	10	T
	13	T
	16	T
	20	T
	25	T
	32	T
	40	T
	50	T
	63	T

T $\hat{=}$ full selectivity up to I_{cu}/I_{cn} rated short-circuit breaking capacity of the downstream protective device.

¹⁾ In 240/415 V, 50 Hz systems, the selectivity limits are reduced by 10 %.
The selectivity limits for adjustable releases apply to the maximum value,
 I_n = rated current. I_i $\hat{=}$ tripping current.

Miniature Circuit Breakers

Configuration and dimensioning

Selectivity of miniature circuit breakers/molded case circuit breakers

Selectivity limit values of miniature circuit breakers/molded case circuit breakers in kA

Downstream miniature circuit breakers			Upstream molded case circuit breakers										
Characteristic B/C	I_n [A]	I_{cn} [kA]	3VL1, TM, non-adjustable										
			16	20	25	32	40	50	63	80	100	125	160
			Selectivity limits [kA]										
			55/70	300	300	300	600	600	600	1000	1000	1000	1500
			Selectivity limits [kA]										
5SL3, 5SL6													
0.5	6		T	T	T	T	T	T	T	T	T	T	T
1	6		T	T	T	T	T	T	T	T	T	T	T
1.6	6		2.5	2.5	2.5	2.5	T	T	T	T	T	T	T
2	6		1.6	1.6	1.6	1.6	4.2	4.2	4.2	T	T	T	T
3	6		1.3	1.3	1.3	1.3	3.8	3.8	3.8	T	T	T	T
4	6		1.3	1.3	1.3	1.3	3.5	3.5	3.5	T	T	T	T
6	6		1.0	1.0	1.0	1.0	2.7	2.7	2.7	5.5	5.5	5.5	T
8	6		0.9	0.9	0.9	0.9	2.5	2.5	2.5	5.0	5.0	5.0	T
10	6		0.9	0.9	0.9	0.9	2.4	2.4	2.4	4.6	4.6	4.6	T
13	6		0.9	0.9	0.9	0.9	2.4	2.4	2.4	4.5	4.5	4.5	T
16	6		--	0.8	0.8	0.8	1.9	1.9	1.9	3.6	3.6	3.6	5.6
20	6		--	--	0.8	0.8	1.9	1.9	1.9	3.5	3.5	3.5	5.6
25	6		--	--	--	0.8	1.8	1.8	1.8	3.4	3.4	3.4	5.4
32	6		--	--	--	--	1.6	1.6	1.6	2.5	2.5	2.5	4.5
40	6		--	--	--	--	--	1.8	1.8	3.3	3.3	3.3	5.5
50	6		--	--	--	--	--	--	1.5	2.5	2.5	2.5	4.7
63	6		--	--	--	--	--	--	--	2.6	2.6	2.6	4.4

Downstream miniature circuit breakers			Upstream molded case circuit breakers										
Characteristic B/C	I_n [A]	I_{cn} [kA]	3VL2, TM, adjustable						3VL2, ETU, adjustable				
			40 ... 50	50 ... 63	63 ... 80	80 to 100	100 ... 125	125 ... 160	25 ... 63	40 ... 100	64 ... 160		
			55/70/100	300 ... 600	300 ... 600	400 ... 800	500 ... 1000	625 ... 1250	800 ... 1600	80 ... 693	125 ... 1100	200 ... 1760	
			Selectivity limits [kA]										
5SL3, 5SL6													
0.5	6		T	T	T	T	T	T	T	T	T	T	
1	6		T	T	T	T	T	T	T	T	T	T	
1.6	6		T	T	T	T	T	T	T	2.8	5.6	T	
2	6		2.5	2.5	4.1	T	T	T	T	1.9	2.9	T	
3	6		2.0	2.0	3.7	5.1	T	T	T	1.7	2.4	T	
4	6		2.0	2.0	3.4	4.7	T	T	T	1.6	2.4	T	
6	6		1.6	1.6	2.5	3.4	4.9	T	T	1.2	1.6	3.6	
8	6		1.5	1.5	2.5	3.2	4.4	5.9	5.9	1.2	1.6	3.2	
10	6		1.5	1.5	2.3	3.0	4.1	5.4	5.4	1.2	1.5	3.1	
13	6		1.2	1.2	2.3	3.0	4.0	5.8	5.8	1.2	1.5	3.0	
16	6		1.2	1.2	1.9	2.5	3.3	4.2	4.2	1.0	1.3	2.6	
20	6		1.2	1.2	1.8	2.0	3.2	4.0	4.0	1.0	1.3	2.6	
25	6		1.2	1.2	1.8	2.0	3.1	3.9	3.9	1.0	1.3	2.5	
32	6		1.2	1.2	1.6	2.0	2.5	3.2	3.2	1.1	1.3	2.5	
40	6		1.2	1.2	1.8	2.0	3.0	3.8	3.8	1.0	1.3	2.6	
50	6		--	1.1	1.6	2.0	2.5	3.3	3.3	1.0	1.2	2.3	
63	6		--	--	1.5	1.5	2.5	3.0	3.0	--	1.2	2.2	

T $\hat{=}$ full selectivity up to rated breaking capacity I_{cn} of the downstream protective device.

¹⁾ In 240/415 V, 50 Hz systems, the selectivity limits are reduced by 10 %.
The selectivity limits for adjustable releases apply to the maximum value,
 I_n = rated current. I_t $\hat{=}$ tripping current.

Selectivity limit values of miniature circuit breakers/molded case circuit breakers in kA

Downstream miniature circuit breakers			Upstream molded case circuit breakers, adjustable									
			3VL3, TM		3VL3, ETU		3VL4, TM			3VL4, ETU		
I_n [A]	160 ... 200	200 ... 250	80 ... 200	100 ... 250	160 ... 200	200 ... 250	250 ... 315	315 ... 400	126 ... 315	160 ... 400		
I_{cu} [kA]	55/70/100		55/70/100		55/70/100			55/70/100				
I_f [A]	1000 ... 2000	1200 ... 2500	250 ... 2200	315 ... 2750	1000 ... 2000	1200 ... 2500	3150	2000 ... 4000	400 ... 3465	500 ... 4400		
I_n [A] ¹⁾ I_{cn} [kA]	Selectivity limits [kA]											
5SL3, 5SL6												
Characteristic B/C	0.5	6	T	T	T	T	T	T	T	T	T	T
	1	6	T	T	T	T	T	T	T	T	T	T
	1.6	6	T	T	T	T	T	T	T	T	T	T
	2	6	T	T	T	T	T	T	T	T	T	T
	3	6	T	T	T	T	T	T	T	T	T	T
	4	6	T	T	T	T	T	T	T	T	T	T
	6	6	T	T	5.5	T	T	T	T	T	T	T
	8	6	T	T	5.0	T	T	T	T	T	T	T
	10	6	T	T	4.7	T	T	T	T	T	T	T
	13	6	T	T	4.6	T	T	T	T	T	T	T
	16	6	T	T	3.8	5.6	T	T	T	T	T	T
	20	6	T	T	3.7	5.2	T	T	T	T	T	T
	25	6	T	T	3.6	5.5	T	T	T	T	T	T
	32	6	T	T	3.4	4.9	T	T	T	T	T	T
	40	6	T	T	3.7	5.5	T	T	T	T	T	T
	50	6	T	T	3.2	4.6	T	T	T	T	T	T
	63	6	T	T	3.0	4.4	T	T	T	T	T	T

Downstream miniature circuit breakers			Upstream molded case circuit breakers, adjustable											
			3VL5, TM				3VL5, ETU		3VL6, ETU		3VL7, ETU		3VL8, ETU	
I_n [A]	250 ... 315	315 ... 400	400 ... 500	500 ... 630	252 ... 630	320 ... 800	400 ... 1000	500 ... 1250	640 ... 1600					
I_{cu} [kA]	55/70/100		55/70/100		55/70/100		55/70/100		55/70/100					
I_f [A]	1575 ... 3150	2000 ... 4000	2500 ... 5000	3250 ... 6300	800 ... 6300	1000 ... 6400	1250 ... 11000	1600 ... 13750	2000 ... 14400					
I_n [A] ¹⁾ I_{cn} [kA]	Selectivity limits [kA]													
5SL3, 5SL6														
Characteristic B/C	0.5	6	T	T	T	T	T	T	T	T	T	T		
	1	6	T	T	T	T	T	T	T	T	T	T		
	1.6	6	T	T	T	T	T	T	T	T	T	T		
	2	6	T	T	T	T	T	T	T	T	T	T		
	3	6	T	T	T	T	T	T	T	T	T	T		
	4	6	T	T	T	T	T	T	T	T	T	T		
	6	6	T	T	T	T	T	T	T	T	T	T		
	8	6	T	T	T	T	T	T	T	T	T	T		
	10	6	T	T	T	T	T	T	T	T	T	T		
	13	6	T	T	T	T	T	T	T	T	T	T		
	16	6	T	T	T	T	T	T	T	T	T	T		
	20	6	T	T	T	T	T	T	T	T	T	T		
	25	6	T	T	T	T	T	T	T	T	T	T		
	32	6	T	T	T	T	T	T	T	T	T	T		
	40	6	T	T	T	T	T	T	T	T	T	T		
	50	6	T	T	T	T	T	T	T	T	T	T		
	63	6	T	T	T	T	T	T	T	T	T	T		

T ≙ full selectivity up to rated breaking capacity I_{cn} of the downstream protective device.

¹⁾ In 240/415 V, 50 Hz systems, the selectivity limits are reduced by 10 %.
The selectivity limits for adjustable releases apply to the maximum value,
 I_n = rated current. I_f ≙ tripping current.

Miniature Circuit Breakers

Configuration and dimensioning

In the event of a short-circuit, selectivity up to the specified values in kA exists between miniature circuit breakers and molded case circuit breakers according to IEC/EN 60947-2.

Selectivity limit values of miniature circuit breakers/molded case circuit breakers in kA

Downstream miniature circuit breakers		Upstream molded case circuit breakers												
		3VL1, TM, non-adjustable						3VL2, TM, adjustable						
I_n [A]		50	63	80	100	125	160	40 ... 50	50 ... 63	63 ... 80	80 ... 100	100 ... 125	125 ... 160	160 ... 200
I_t [A]		600	600	1000	1000	1250	1500	300 ... 600	300 ... 600	400 ... 800	500 ... 1000	625 ... 1250	800 ... 1600	
I_{cu} [kA]		55/70	55/70	55/70	55/70	55/70	55/70	55/70/100	55/70/100	55/70/100	55/70/100	55/70/100	55/70/100	55/70/100
I_n [A] ¹⁾	I_{cn} [kA]	Selectivity limits [kA]												
5SY4...-5														
Characteristic A	2	10	T	T	T	T	T	T	T	T	T	T	T	T
	10	10	1.6	4.7	6	T	T	T	2.5	4	4	4.5	4.9	T
	16	10	1.4	4.7	6	T	T	T	2.3	3.7	3.7	4.4	5	T
	32	10	1.2	3.6	4.6	T	T	T	1.8	3	3	3.5	3.7	6
	40	10	1	2.5	3.1	6	T	T	1.5	2	2	2.4	2.7	3.2
5SY6...-6, 5SY4...-6, 5SY7...-6, 5SJ4...-6HG40²⁾														
Characteristic B	6	6/10/15	5.5	5.5	T	T	T	2.5	2.5	5.1	7.3	T	T	
	10	6/10/15	3.1	3.1	6.7	6.7	6.7	6/12/4	2.0	3.0	3.9	5.0	8.6	
	13	6/10/15	2.5	2.5	5.0	5.0	5.0	8.0	1.5	1.5	3.1	3.4	4.5	5.8
	16	6/10/15	2.5	2.5	4.4	4.4	4.4	7.2	1.5	1.5	2.0	3.1	4.0	5.1
	20	6/10/15	2.0	2.0	4.3	4.3	4.3	6.6	1.5	1.5	2.0	2.5	3.9	5.0
	25	6/10/15	2.0	2.0	3.9	3.9	3.9	6.1	1.5	1.5	2.0	2.1	3.4	4.6
	32	6/10/15	2.0	2.0	3.7	3.7	3.7	5.0	1.5	1.5	2.0	2.1	3.4	4.8
	40	6/10/15	2.0	2.0	3.7	3.7	3.7	5.0	1.2	1.2	2.0	2.1	3.3	4.3
	50	6/10/15	--	1.5	3.2	3.2	3.2	4.0	--	--	1.5	2.0	2.5	3.6
	5SY6...-7, 5SY4...-7, 5SY7...-7, 5SJ4...-7HG..²⁾													
Characteristic C	0.5	6/10/15	T	T	T	T	T	T	T	T	T	T	T	T
	1	6/10/15	T	T	T	T	T	T	T	T	T	T	T	T
	1.5	6/10/15	T	T	T	T	T	T	T	T	T	T	T	T
	2	6/10/15	T	T	T	T	T	T	T	T	T	T	T	T
	3	6/10/15	3.2	3.2	T	T	T	T	2.5	T	T	T	T	T
	4	6/10/15	3.2	3.2	T	T	T	T	2.5	T	T	T	T	T
	6	6/10/15	3.2	3.2	7	7	7	6/10/13.9	2.5	2.5	5.1	7.3	T	T
	8	6/10/15	2.5	2.5	5.4	5.4	5.4	6/9/2	2.3	3.7	3.8	3.9	5.6	8.6
	10	6/10/15	2.5	2.5	5.4	5.4	5.4	6/9/2	2.0	2.0	3.0	3.4	5.6	8.6
	13	6/10/15	2.5	2.5	4.3	4.3	4.3	7.1	1.5	1.5	2.5	3.4	4.5	5.8
	16	6/10/15	2.0	2.5	4.0	4.0	4.0	7.1	1.5	1.5	2.5	3.1	4.0	5.1
	20	6/10/15	2.0	2.0	3.7	3.7	3.7	6.3	1.5	1.5	2.0	2.5	3.9	5.0
	25	6/10/15	2.0	2.0	3.6	3.6	3.6	5.5	1.5	1.5	2.0	2.5	3.5	4.6
	32	6/10/15	2.0	2.0	3.5	3.5	3.5	5.5	1.5	1.5	2.0	2.5	3.4	4.5
	40	6/10/15	1.5	1.5	3.3	3.3	3.3	5.1	1.2	1.2	2.0	2.5	3.3	4.3
	50	6/10/15	--	1.5	3.1	3.1	3.1	4.0	--	--	1.5	2.5	2.5	3.6
5SY4...-8, 5SY7...-8, 5SJ4...-8HG..²⁾														
Characteristic D	2	10/15	2.4	6	6	6	6	6	4.2	6	6	6	6	6
	6	10/15	1.4	1.4	4.8	5	6	6	2.3	4.1	4.2	4.2	4.3	6
	10	10/15	1.3	1.3	4.5	5	6	6	1.9	3.7	3.7	3.7	4	6
	16	10/15	1.1	1.1	3.2	3.2	3.2	4.0	1.7	3.3	3.7	3.3	3.5	4.7
	32	10/15	--	--	2.3	2.3	2.3	4.0	--	--	--	2.4	2.7	3.7
	40	10/15	--	--	--	2.1	2.1	3.8	--	--	--	--	1.5	3
50	10/15	--	--	--	--	2.0	2.8	--	--	--	--	--	2.6	
5SP4...-7														
Characteristic C	80	10	--	--	--	1.0	1.2	2.0	--	--	--	--	1.2	1.5
	100	10	--	--	--	--	1.2	1.5	--	--	--	--	--	1.5
5SP4...-8														
Characteristic D	80	10	--	--	--	--	--	--	--	--	--	--	--	--
	100	10	--	--	--	--	--	--	--	--	--	--	--	--

Values for 5SY8 on request.

T = full selectivity up to rated breaking capacity I_{cn} of the downstream protective device.

¹⁾ In 240/415 V, 50 Hz systems, the selectivity limits are reduced by 10 %.
The selectivity limits for adjustable releases apply to the maximum value,
 I_n = rated current. I_t = tripping current.

²⁾ The values specified for 5SJ4...-HG.. are not according to UL but are the manufacturer's specifications according to EN 60947-2 and apply for voltage $U_n = 230 V \sim$. For available rated currents, see Catalog LV 10.

In the event of a short-circuit, selectivity up to the specified values in kA exists between miniature circuit breakers and circuit breakers/molded circuit breakers according to IEC/EN 60947-2.

Selectivity limit values of miniature circuit breakers/molded case circuit breakers/circuit breakers in kA

Downstream miniature circuit breakers	Upstream molded case circuit breakers/circuit breakers															
	3VL3, TM		3VL4, TM				3VL5, TM			3VL5, ETU		3VL6, ETU		3VL7, ETU	3VL8, ETU	3WN1
I_n [A]	200	250	200	250	315	400	315	400	500	630	315	400 ... 800	400 ... 1250	800 ... 2500	315 ... 6300	315 ... 3200
I_t [A]	2000	2500	2000	2500	3150	4000	3150	4000	5000	6300	3200	1575 ... 6400	15000	20000	3780 ... 75600	3780 ... 48000
I_{cu} [kA]	55/70/ 100	55/70/ 100	55/70/ 100	55/70/ 100	55/70/ 100	55/70/ 100	55/70/ 100	55/70/ 100	55/70/ 100	55/70/ 100	55/70/ 100	55/70/ 100	55/70/ 100	55/70/ 100	65 ... 100	65/75
I_n [A] ¹⁾ I_{cn} [kA]	Selectivity limits [kA]															
5SY4...-5, 5SY7...-5																
Characteristic A																
2	10	T	T	T	T	T	T	T	T	T	T	--	T	T	T	T
10	10	T	T	T	T	T	T	T	T	T	T	--	T	T	T	T
16	10	T	T	T	T	T	T	T	T	T	T	--	T	T	T	T
32	10	T	T	T	T	T	T	T	T	T	T	--	T	T	T	T
40	10	T	T	T	T	T	T	T	T	T	T	--	T	T	T	T
5SY6...-6, 5SY4...-6, 5SY7...-6, 5SJ4...-6HG40⁴⁾																
Characteristic B																
6	6/10/15	T	T	T	T	T	T	T	T	T	T	--	T	T	T	T
10	6/10/15	T	T	T	T	T	T	T	T	T	T	--	T	T	T	T
13	6/10/15	T	T	T	T	T	T	T	T	T	T	--	T	T	T	T
16	6/10/15	T	T	T	T	T	T	T	T	T	T	--	T	T	T	T
20	6/10/15	T	T	T	T	T	T	T	T	T	T	--	T	T	T	T
25	6/10/15	T	T	T	T	T	T	T	T	T	T	--	T	T	T	T
32	6/10/15	T	T	T	T	T	T	T	T	T	T	--	T	T	T	T
40	6/10/15	6	6	6	T	T	T	T	T	T	T	--	T	T	T	T
50	6/10/15	6	6	6/10 14.1	T	T	T	T	T	T	T/T/13,8 ²⁾ or 14 ³⁾	--	T	T	T	T
5SY6...-7, 5SY4...-7, 5SY7...-7, 5SJ4...-7HG..⁴⁾																
Characteristic C																
0.5	6/10/15	T	T	T	T	T	T	T	T	T	T	--	T	T	T	T
1	6/10/15	T	T	T	T	T	T	T	T	T	T	--	T	T	T	T
1.5	6/10/15	T	T	T	T	T	T	T	T	T	T	--	T	T	T	T
2	6/10/15	T	T	T	T	T	T	T	T	T	T	--	T	T	T	T
3	6/10/15	T	T	T	T	T	T	T	T	T	T	--	T	T	T	T
4	6/10/15	T	T	T	T	T	T	T	T	T	T	--	T	T	T	T
6	6/10/15	T	T	T	T	T	T	T	T	T	T	--	T	T	T	T
8	6/10/15	T	T	T	T	T	T	T	T	T	T	--	T	T	T	T
10	6/10/15	T	T	T	T	T	T	T	T	T	T	--	T	T	T	T
13	6/10/15	T	T	T	T	T	T	T	T	T	T	--	T	T	T	T
16	6/10/15	T	T	T	T	T	T	T	T	T	T	--	T	T	T	T
20	6/10/15	T	T	T	T	T	T	T	T	T	T	--	T	T	T	T
25	6/10/15	T	T	T	T	T	T	T	T	T	T	--	T	T	T	T
32	6/10/15	6/10 11	T	T	T	T	T	T	T	T	T	--	T	T	T	T
40	6/10/15	6/10	T	T	T	T	T	T	T	T	T	--	T	T	T	T
50	6/10/15	6/10	T	T	T	T	T	T	T	T	T/T/14,2 ²⁾ or T ³⁾	--	T	T	T	T
5SY4...-8, 5SY7...-8, 5SJ4...-8HG..⁴⁾																
Characteristic D																
2	10/15	T	T	T	T	T	T	T	T	T	T	T	T	T	T	T
6	10/15	T	T	T	T	T	T	T	T	T	T	T	T	T	T	T
10	10/15	T	T	T	T	T	T	T	T	T	T	T	T	T	T	T
16	10/15	T	T	T	T	T	T	T	T	T	T	T	T	T	T	T
32	10/15	T	T	T	T	T	T	T	T	T	T	T	T	T	T	T
40	10/15	T	T	T	T	T	T	T	T	T	T	T	T	T	T	T
50	10/15	T	T	T	T	T	T	T	T	T	T	T	T	T	T	T
5SP4...-7																
Characteristic C																
80	10	3	3	3	3	3	6	6.3	7.6	T	8.8	8	T	T	T	T
100	10	3	3	3	3	3	5	5	6.8	T	8.3	6	T	T	T	T
5SP4...-8																
Characteristic D																
80	10	3	3	2.5	3	3	5	5.1	6.9	T	7.2	6	T	T	T	T
100	10	--	2.5	--	3	3	5	4.5	6.6	T	7	6	T	T	T	T

Values for 5SY8 on request.

T ≙ full selectivity up to rated breaking capacity I_{cn} of the downstream protective device.

1) In 240/415 V, 50 Hz systems, the selectivity limits are reduced by 10 %. The selectivity limits for adjustable releases apply to the maximum value, I_n = rated current. I_t ≙ tripping current.

2) Valid for ETU 20/22.

3) Valid for ETU 10/12/40/42.

4) The values specified for 5SJ4...-HG.. are not according to UL but are the manufacturer's specifications according to EN 60947-2 and apply for voltage U_e = 230 V ~. For available rated currents, see Catalog LV 10.

Miniature Circuit Breakers

Configuration and dimensioning

Selectivity limit values of miniature circuit breakers/molded case circuit breakers

Miniature circuit breakers Releases		Selectivity of the 5SL4... for the upstream molded case circuit breakers 3VL1... [kA]										
		3VL1										
Rated current		TM										
I_n [A] ¹⁾		16	20	25	32	40	50	63	80	100	125	160
Circuit breaker type:	1	T	T	T	T	T	T	T	T	T	T	T
5SL4...-.	2	T	T	T	T	T	T	T	T	T	T	T
Characteristic B	3	5.9	5.9	5.9	5.9	T	T	T	T	T	T	T
I_{cn} [kA] = 10	4	1.9	1.9	1.9	1.9	T	T	T	T	T	T	T
	6	1.6	1.6	1.6	1.6	6.8	6.8	6.8	T	T	T	T
	8	1.4	1.4	1.4	1.4	4.8	4.8	4.8	T	T	T	T
	10	1.2	1.2	1.2	1.2	3.8	3.8	3.8	T	T	T	T
	13	1.1	1.1	1.1	1.1	3.1	3.1	3.1	6.7	6.7	6.7	T
	16	---	1	1	1	2.7	2.7	2.7	5.4	5.4	5.4	T
	20	---	---	0.9	0.9	2.5	2.5	2.5	5.2	5.2	5.2	8.5
	25	---	---	---	0.9	2.4	2.4	2.4	4.6	4.6	4.6	7.4
	32	---	---	---	---	2	2	2	3.9	3.9	3.9	6.5
	40	---	---	---	---	---	2	2	4	4	4	5.4
	50	---	---	---	---	---	---	1.7	3	3	3	5.4
	63	---	---	---	---	---	---	---	2.8	2.8	2.8	4.8
Circuit breaker type:	0.3	T	T	T	T	T	T	T	T	T	T	T
5SL4...-.	0.5	T	T	T	T	T	T	T	T	T	T	T
Characteristic C	1	T	T	T	T	T	T	T	T	T	T	T
I_{cn} [kA] = 10	1.6	T	T	T	T	T	T	T	T	T	T	T
	2	2.7	2.7	2.7	2.7	T	T	T	T	T	T	T
	3	1.8	1.8	1.8	1.8	8.6	8.6	8.6	T	T	T	T
	4	1.6	1.6	1.6	1.6	6.4	6.4	6.4	T	T	T	T
	6	1.2	1.2	1.2	1.2	4.1	4.1	4.1	T	T	T	T
	8	0.9	0.9	0.9	0.9	2.3	2.3	2.3	6	6	6	T
	10	0.9	0.9	0.9	0.9	2.3	2.3	2.3	6	6	6	T
	13	0.9	0.9	0.9	0.9	2.3	2.3	2.3	4.4	4.4	4.4	8.3
	16	---	0.9	0.9	0.9	2.3	2.3	2.3	4.4	4.4	4.4	8.3
	20	---	---	0.8	0.8	2	2	2	3.9	3.9	3.9	6.6
	25	---	---	---	0.8	2	2	2	3.9	3.9	3.9	6.6
	32	---	---	---	---	1.8	1.8	1.8	3.4	3.4	3.4	6.1
	40	---	---	---	---	---	1.8	1.8	3.5	3.5	3.5	6.1
	50	---	---	---	---	---	---	1.5	3.2	3.2	3.2	4.9
	63	---	---	---	---	---	---	---	3.2	3.2	3.2	4.9
Circuit breaker type:	0.3	T	T	T	T	T	T	T	T	T	T	T
5SL4...-.	0.5	T	T	T	T	T	T	T	T	T	T	T
Characteristic D	1	T	T	T	T	T	T	T	T	T	T	T
I_{cn} [kA] = 10	1.6	3.1	3.1	3.1	3.1	T	T	T	T	T	T	T
	2	2.1	2.1	2.1	2.1	T	T	T	T	T	T	T
	3	1.6	1.6	1.6	1.6	6.3	6.3	6.3	T	T	T	T
	4	1.3	1.3	1.3	1.3	4.5	4.5	4.5	T	T	T	T
	6	1.1	1.1	1.1	1.1	3.5	3.5	3.5	T	T	T	T
	8	0.7	0.7	0.7	0.7	2	2	2	4.5	4.5	4.5	9.8
	10	0.7	0.7	0.7	0.7	2	2	2	4.5	4.5	4.5	9.8
	13	0.7	0.7	0.7	0.7	2	2	2	3.9	3.9	3.9	6.8
	16	---	0.7	0.7	0.7	2	2	2	3.9	3.9	3.9	6.8
	20	---	---	0.7	0.7	1.8	1.8	1.8	3.6	3.6	3.6	6.2
	25	---	---	---	0.7	1.8	1.8	1.8	3.6	3.6	3.6	6.2
	32	---	---	---	---	1.9	1.9	1.9	3.8	3.8	3.8	6.2
	40	---	---	---	---	---	1.6	1.6	3.2	3.2	3.2	5.6
	50	---	---	---	---	---	---	---	2.4	2.4	2.4	4.4
	63	---	---	---	---	---	---	---	2.4	2.4	2.4	4.4

T $\hat{=}$ full selectivity up to I_{cu}/I_{cn} rated short-circuit breaking capacity of the downstream protective device.

¹⁾ In 240/415 V, 50 Hz systems, the selectivity limits are reduced by 10 %.
The selectivity limits for adjustable releases apply to the maximum value,
 I_n = rated current. I_i $\hat{=}$ tripping current.

Selectivity limit values of miniature circuit breakers/molded case circuit breakers

Miniature circuit breakers Releases		Selectivity of the 5SL4... for the upstream molded case circuit breakers 3VL2... [kA]									
		3VL2							ETU		
Rated current	I_n [A] ¹⁾	TM	50	63	80	100	125	160	63	100	160
Circuit breaker type:	1	T	T	T	T	T	T	T	T	T	T
5SL4...-.	2	T	T	T	T	T	T	T	T	T	T
Characteristic B	3	T	T	T	T	T	T	T	4.4	T	T
I_{cn} [kA] = 10	4	4.5	4.5	9.8	T	T	T	T	2.1	3.4	T
	6	2.9	2.9	6.2	9.9	T	T	T	1.7	2.6	8.2
	8	2.4	2.4	4.3	6	T	T	T	1.5	2.2	5.6
	10	2.2	2.2	3.4	4.9	7.6	T	T	1.3	1.9	4.4
	13	2	2	2.9	4.1	5.7	9.2	T	1.3	1.8	4.1
	16	1.6	1.6	2.7	3.3	4.7	6.4	T	1.1	1.5	3.4
	20	1.5	1.5	2.3	3.1	4.4	6.1	T	1.1	1.5	3.1
	25	1.4	1.4	2.2	2.9	4.1	5.7	T	1.1	1.4	2.9
	32	1.3	1.3	1.9	2.6	3.4	4.7	T	1	1.3	2.6
	40	1.2	1.2	1.9	2.6	3.5	4.6	T	1	1.3	2.6
	50	---	1.1	1.7	2.2	2.8	3.7	T	0.9	1.2	2.3
	63	---	---	1.5	2	2.6	3.4	T	---	1.2	2.2
Circuit breaker type:	0.3	T	T	T	T	T	T	T	T	T	T
5SL4...-.	0.5	T	T	T	T	T	T	T	T	T	T
Characteristic C	1	T	T	T	T	T	T	T	T	T	T
I_{cn} [kA] = 10	1.6	T	T	T	T	T	T	T	6.8	T	T
	2	6.5	6.5	T	T	T	T	T	2.7	4.9	T
	3	3.9	3.9	7.2	T	T	T	T	2	3.1	9.8
	4	3	3	5.8	8.4	T	T	T	1.7	2.6	8.4
	6	2.2	2.2	3.7	5.5	T	T	T	1.4	2.1	5.3
	8	1.5	1.5	2.2	2.9	5.2	7.3	T	1.1	1.4	3.1
	10	1.5	1.5	2.2	2.9	5.2	7.3	T	1.1	1.4	3.1
	13	1.5	1.5	2.2	2.9	4	6	T	1.1	1.4	3
	16	1.5	1.5	2.2	2.9	4	6	T	1.1	1.4	3
	20	1.3	1.3	1.9	2.6	3.5	4.8	T	1	1.3	2.6
	25	1.3	1.3	1.9	2.6	3.5	4.8	T	1	1.3	2.6
	32	1.1	1.1	1.7	2.3	3	4.2	T	0.9	1.3	2.5
	40	1.1	1.1	1.7	2.3	3.1	4.3	T	0.9	1.2	2.4
	50	---	1	1.5	2.1	2.9	3.7	T	0.9	1.2	2.3
	63	---	---	1.5	2.1	2.9	3.7	T	---	1.2	2.3
Circuit breaker type:	0.3	T	T	T	T	T	T	T	T	T	T
5SL4...-.	0.5	T	T	T	T	T	T	T	T	T	T
Characteristic D	1	T	T	T	T	T	T	T	8.4	T	T
I_{cn} [kA] = 10	1.6	T	T	T	T	T	T	T	2.8	6.2	T
	2	4.4	4.4	T	T	T	T	T	2.3	3.7	T
	3	2.9	2.9	5.9	9.5	T	T	T	1.8	2.7	8.5
	4	2.5	2.5	4.2	5.9	T	T	T	1.5	2.3	5.9
	6	1.9	1.9	3.3	4.4	6.8	T	T	1.3	1.9	4.3
	8	1.2	1.2	1.9	2.6	3.8	5.5	T	1	1.3	2.6
	10	1.2	1.2	1.9	2.6	3.8	5.5	T	1	1.3	2.6
	13	1.2	1.2	1.9	2.6	3.5	4.8	T	1	1.3	2.6
	16	1.2	1.2	1.9	2.6	3.5	4.8	T	1	1.3	2.6
	20	1.1	1.1	1.7	2.3	3.1	4.4	T	0.9	1.3	2.5
	25	1.1	1.1	1.7	2.3	3.1	4.4	T	0.9	1.3	2.5
	32	1.1	1.1	1.9	2.5	3.4	4.5	T	0.9	1.2	2.5
	40	1	1	1.6	2	2.9	3.8	T	0.9	1.2	2.3
	50	---	---	---	1.7	2.3	2.8	T	---	---	2.1
	63	---	---	---	1.7	2.3	2.8	T	---	---	2.1

T $\hat{=}$ full selectivity up to I_{cu}/I_{cn} rated short-circuit breaking capacity of the downstream protective device.

¹⁾ In 240/415 V, 50 Hz systems, the selectivity limits are reduced by 10 %.
The selectivity limits for adjustable releases apply to the maximum value,
 I_n = rated current. I_t $\hat{=}$ tripping current.

Miniature Circuit Breakers

Configuration and dimensioning

Selectivity limit values of miniature circuit breakers/molded case circuit breakers

Miniature circuit breakers		Selectivity of the 5SL4... for the upstream molded case circuit breakers 3VL3... [kA] or 3VL4... [kA]									
		3VL3				3VL4					
		TM	ETU		TM	ETU					
Rated current	I_n [A] ¹⁾	200	250	200	250	200	250	315	400	315	400
Circuit breaker type:	1	T	T	T	T	T	T	T	T	T	T
5SL4...-.	2	T	T	T	T	T	T	T	T	T	T
Characteristic B	3	T	T	T	T	T	T	T	T	T	T
I_{cn} [kA] = 10	4	T	T	T	T	T	T	T	T	T	T
	6	T	T	T	T	T	T	T	T	T	T
	8	T	T	9.3	T	T	T	T	T	T	T
	10	T	T	7.7	T	T	T	T	T	T	T
	13	T	T	6.7	T	T	T	T	T	T	T
	16	T	T	5.2	8	T	T	T	T	T	T
	20	T	T	4.9	7.9	T	T	T	T	T	T
	25	T	T	4.3	7	T	T	T	T	T	T
	32	T	T	3.8	5.9	T	T	T	T	T	T
	40	T	T	3.7	5.1	T	T	T	T	T	T
	50	T	T	3.1	4.9	T	T	T	T	T	T
	63	9.9	T	3	4.3	T	T	T	T	T	T
Circuit breaker type:	0.3	T	T	T	T	T	T	T	T	T	T
5SL4...-.	0.5	T	T	T	T	T	T	T	T	T	T
Characteristic C	1	T	T	T	T	T	T	T	T	T	T
I_{cn} [kA] = 10	1.6	T	T	T	T	T	T	T	T	T	T
	2	T	T	T	T	T	T	T	T	T	T
	3	T	T	T	T	T	T	T	T	T	T
	4	T	T	T	T	T	T	T	T	T	T
	6	T	T	8.7	T	T	T	T	T	T	T
	8	T	T	5.9	8.9	T	T	T	T	T	T
	10	T	T	5.9	8.9	T	T	T	T	T	T
	13	T	T	4.4	7.3	T	T	T	T	T	T
	16	T	T	4.4	7.3	T	T	T	T	T	T
	20	T	T	3.8	5.9	T	T	T	T	T	T
	25	T	T	3.8	5.9	T	T	T	T	T	T
	32	T	T	3.4	5.4	T	T	T	T	T	T
	40	T	T	3.4	5.2	T	T	T	T	T	T
	50	8.3	T	3.2	4.3	T	T	T	T	9.3	9.2
	63	8.3	T	3.2	4.3	T	T	T	T	9.3	9.2
Circuit breaker type:	0.3	T	T	T	T	T	T	T	T	T	T
5SL4...-.	0.5	T	T	T	T	T	T	T	T	T	T
Characteristic D	1	T	T	T	T	T	T	T	T	T	T
I_{cn} [kA] = 10	1.6	T	T	T	T	T	T	T	T	T	T
	2	T	T	T	T	T	T	T	T	T	T
	3	T	T	T	T	T	T	T	T	T	T
	4	T	T	T	T	T	T	T	T	T	T
	6	T	T	7.4	T	T	T	T	T	T	T
	8	T	T	4.3	7.3	T	T	T	T	T	T
	10	T	T	4.3	7.3	T	T	T	T	T	T
	13	T	T	3.8	6.1	T	T	T	T	T	T
	16	T	T	3.8	6.1	T	T	T	T	T	T
	20	T	T	3.6	5.5	T	T	T	T	T	T
	25	T	T	3.6	5.5	T	T	T	T	T	T
	32	T	T	3.6	5.4	T	T	T	T	T	T
	40	T	T	3.2	4.7	T	T	T	T	T	T
	50	8	T	2.8	4	T	T	T	T	9.2	9.1
	63	8	T	2.8	4	T	T	T	T	9.2	9.1

T $\hat{=}$ full selectivity up to I_{cu}/I_{cn} rated short-circuit breaking capacity of the downstream protective device.

¹⁾ In 240/415 V, 50 Hz systems, the selectivity limits are reduced by 10 %.
The selectivity limits for adjustable releases apply to the maximum value,
 I_n = rated current. I_t $\hat{=}$ tripping current.

Selectivity limit values of miniature circuit breakers/molded case circuit breakers

Miniature circuit breakers		Selectivity of the 5SL4... for the upstream molded case circuit breakers 3VL5/6/7/8... [kA]								
		3VL5					3VL6	3VL7		3VL8
Releases		TM				ETU	ETU	ETU		ETU
Rated current	I_n [A] ¹⁾	315	400	500	630	630	800	1000	1250	1600
Circuit breaker type:	1	T	T	T	T	T	T	T	T	T
5SL4...-.	2	T	T	T	T	T	T	T	T	T
Characteristic B	3	T	T	T	T	T	T	T	T	T
I_{cn} [kA] = 10	4	T	T	T	T	T	T	T	T	T
	6	T	T	T	T	T	T	T	T	T
	8	T	T	T	T	T	T	T	T	T
	10	T	T	T	T	T	T	T	T	T
	13	T	T	T	T	T	T	T	T	T
	16	T	T	T	T	T	T	T	T	T
	20	T	T	T	T	T	T	T	T	T
	25	T	T	T	T	T	T	T	T	T
	32	T	T	T	T	T	T	T	T	T
	40	T	T	T	T	T	T	T	T	T
	50	T	T	T	T	T	T	T	T	T
	63	T	T	T	T	T	T	T	T	T
Circuit breaker type:	0.3	T	T	T	T	T	T	T	T	T
5SL4...-.	0.5	T	T	T	T	T	T	T	T	T
Characteristic C	1	T	T	T	T	T	T	T	T	T
I_{cn} [kA] = 10	1.6	T	T	T	T	T	T	T	T	T
	2	T	T	T	T	T	T	T	T	T
	3	T	T	T	T	T	T	T	T	T
	4	T	T	T	T	T	T	T	T	T
	6	T	T	T	T	T	T	T	T	T
	8	T	T	T	T	T	T	T	T	T
	10	T	T	T	T	T	T	T	T	T
	13	T	T	T	T	T	T	T	T	T
	16	T	T	T	T	T	T	T	T	T
	20	T	T	T	T	T	T	T	T	T
	25	T	T	T	T	T	T	T	T	T
	32	T	T	T	T	T	T	T	T	T
	40	T	T	T	T	T	T	T	T	T
	50	T	T	T	T	T	T	T	T	T
	63	T	T	T	T	T	T	T	T	T
Circuit breaker type:	0.3	T	T	T	T	T	T	T	T	T
5SL4...-.	0.5	T	T	T	T	T	T	T	T	T
Characteristic D	1	T	T	T	T	T	T	T	T	T
I_{cn} [kA] = 10	1.6	T	T	T	T	T	T	T	T	T
	2	T	T	T	T	T	T	T	T	T
	3	T	T	T	T	T	T	T	T	T
	4	T	T	T	T	T	T	T	T	T
	6	T	T	T	T	T	T	T	T	T
	8	T	T	T	T	T	T	T	T	T
	10	T	T	T	T	T	T	T	T	T
	13	T	T	T	T	T	T	T	T	T
	16	T	T	T	T	T	T	T	T	T
	20	T	T	T	T	T	T	T	T	T
	25	T	T	T	T	T	T	T	T	T
	32	T	T	T	T	T	T	T	T	T
	40	T	T	T	T	T	T	T	T	T
	50	T	T	T	T	T	T	T	T	T
	63	T	T	T	T	T	T	T	T	T

T ≙ full selectivity up to I_{cu}/I_{cn} rated short-circuit breaking capacity of the downstream protective device.

¹⁾ In 240/415 V, 50 Hz systems, the selectivity limits are reduced by 10 %.
The selectivity limits for adjustable releases apply to the maximum value,
 I_n = rated current. I_t ≙ tripping current.

Miniature Circuit Breakers

Configuration and dimensioning

Selectivity limit values of miniature circuit breakers/molded case circuit breakers in kA

		Selectivity of the 5SL3... for the upstream molded case circuit breaker 3VA2... [kA]										
		3VA2				160 A				250 A		
		100 A										
Molded case circuit breakers		ETU320, ETU330, ETU340, ETU350, ETU550, ETU560										
Size												
Releases												
Rated current	I_n [A] ¹⁾	25	40	63	100	25	40	63	100	160	160	250
Circuit breaker type:	6	T	T	T	T	T	T	T	T	T	T	T
5SL3...-	10	3.7	T	T	T	4	T	T	T	T	T	T
Characteristic B	13	3.7	T	T	T	4	T	T	T	T	T	T
I_{cn} [kA] = 4.5	16	2.8	T	T	T	3.2	T	T	T	T	T	T
	20	2.7	T	T	T	3.1	T	T	T	T	T	T
	25	---	T	T	T	---	T	T	T	T	T	T
	32	---	3.5	T	T	---	3.6	T	T	T	T	T
	40	---	---	T	T	---	---	T	T	T	T	T
	50	---	---	T	T	---	---	T	T	T	T	T
	63	---	---	---	T	---	---	---	T	T	T	T
Circuit breaker type:	0.3	T	T	T	T	T	T	T	T	T	T	T
5SL3...-	0.5	T	T	T	T	T	T	T	T	T	T	T
Characteristic C	1	T	T	T	T	T	T	T	T	T	T	T
I_{cn} [kA] = 4.5	1.6	T	T	T	T	T	T	T	T	T	T	T
	2	T	T	T	T	T	T	T	T	T	T	T
	3	T	T	T	T	T	T	T	T	T	T	T
	4	T	T	T	T	T	T	T	T	T	T	T
	6	T	T	T	T	T	T	T	T	T	T	T
	8	4	T	T	T	T	T	T	T	T	T	T
	10	3.7	T	T	T	4	T	T	T	T	T	T
	13	3.7	T	T	T	4	T	T	T	T	T	T
	16	2.8	T	T	T	3.2	T	T	T	T	T	T
	20	2.7	T	T	T	3.1	T	T	T	T	T	T
	25	---	T	T	T	---	T	T	T	T	T	T
	32	---	3.5	T	T	---	3.6	T	T	T	T	T
	40	---	---	T	T	---	---	T	T	T	T	T
	50	---	---	T	T	---	---	T	T	T	T	T
	63	---	---	---	T	---	---	---	T	T	T	T

T ≙ full selectivity up to I_{cu}/I_{cn} rated short-circuit breaking capacity of the downstream protective device.

¹⁾ In 240/415 V, 50 Hz systems, the selectivity limits are reduced by 10 %.
The selectivity limits for adjustable releases apply to the maximum value,
 I_n = rated current, I_t ≙ tripping current.

Selectivity limit values of miniature circuit breakers/molded case circuit breakers in kA

Molded case circuit breakers		Selectivity of the 5SL4... for the upstream molded case circuit breaker 3VA2... [kA]											
		3VA2 100 A					160 A					250 A	
		25	40	63	100	25	40	63	100	160	160	250	
Size	I_n [A] ¹⁾												
Rated current													
Circuit breaker type:													
5SL4...-	1	T	T	T	T	T	T	T	T	T	T	T	
Characteristic B	2	T	T	T	T	T	T	T	T	T	T	T	
I_{cn} [kA] = 10	3	T	T	T	T	T	T	T	T	T	T	T	
	4	T	T	T	T	T	T	T	T	T	T	T	
	6	T	T	T	T	T	T	T	T	T	T	T	
	8	T	T	T	T	T	T	T	T	T	T	T	
	10	T	T	T	T	T	T	T	T	T	T	T	
	13	5.5	T	T	T	5.9	T	T	T	T	T	T	
	16	4.4	T	T	T	4.9	T	T	T	T	T	T	
	20	4.2	T	8	8	4.6	T	T	T	T	T	T	
	25	---	T	8	8	---	T	T	T	T	T	T	
	32	---	T	8	8	---	T	T	T	T	T	T	
	40	---	---	8	8	---	---	T	T	T	T	T	
	50	---	---	8	8	---	---	T	T	T	T	T	
	63	---	---	---	8	---	---	---	T	T	T	T	
Circuit breaker type:													
5SL4...-	0.3	T	T	T	T	T	T	T	T	T	T	T	
Characteristic C	0.5	T	T	T	T	T	T	T	T	T	T	T	
I_{cn} [kA] = 10	1	T	T	T	T	T	T	T	T	T	T	T	
	1.6	T	T	T	T	T	T	T	T	T	T	T	
	2	T	T	T	T	T	T	T	T	T	T	T	
	3	T	T	T	T	T	T	T	T	T	T	T	
	4	T	T	T	T	T	T	T	T	T	T	T	
	6	T	T	T	T	T	T	T	T	T	T	T	
	8	5.1	T	T	T	5.6	T	T	T	T	T	T	
	10	5.1	T	T	T	5.6	T	T	T	T	T	T	
	13	3.7	T	T	T	4	T	T	T	T	T	T	
	16	3.7	T	T	T	4	T	T	T	T	T	T	
	20	3	T	8	8	3.5	7.3	T	T	T	T	T	
	25	---	T	8	8	---	7.3	T	T	T	T	T	
	32	---	7.1	8	8	---	6.9	T	T	T	T	T	
	40	---	---	8	8	---	---	T	T	T	T	T	
	50	---	---	8	8	---	---	T	T	T	T	T	
	63	---	---	---	8	---	---	---	T	T	T	T	
Circuit breaker type:													
5SL4...-	0.3	T	T	T	T	T	T	T	T	T	T	T	
Characteristic D	0.5	T	T	T	T	T	T	T	T	T	T	T	
I_{cn} [kA] = 10	1	T	T	T	T	T	T	T	T	T	T	T	
	1.6	T	T	T	T	T	T	T	T	T	T	T	
	2	T	T	T	T	T	T	T	T	T	T	T	
	3	T	T	T	T	T	T	T	T	T	T	T	
	4	T	T	T	T	T	T	T	T	T	T	T	
	6	6.7	T	T	T	7.1	T	T	T	T	T	T	
	8	3.3	T	T	T	3.9	T	T	T	T	T	T	
	10	3.3	T	T	T	3.9	T	T	T	T	T	T	
	13	3.2	T	T	T	3.6	T	T	T	T	T	T	
	16	3.2	T	T	T	3.6	T	T	T	T	T	T	
	20	2.6	T	8	8	3.1	T	T	T	T	T	T	
	25	---	T	8	8	---	T	T	T	T	T	T	
	32	---	T	8	8	---	T	T	T	T	T	T	
	40	---	---	8	8	---	---	T	T	T	T	T	
	50	---	---	8	8	---	---	T	T	T	T	T	
	63	---	---	---	8	---	---	---	T	T	T	T	

T ≙ full selectivity up to I_{cu}/I_{cn} rated short-circuit breaking capacity of the downstream protective device.

¹⁾ In 240/415 V, 50 Hz systems, the selectivity limits are reduced by 10 %.
The selectivity limits for adjustable releases apply to the maximum value,
 I_n = rated current. I_t ≙ tripping current.

Miniature Circuit Breakers

Configuration and dimensioning

Selectivity limit values of miniature circuit breakers/molded case circuit breakers in kA

Molded case circuit breakers		Selectivity of the 5SL6... for the upstream molded case circuit breaker 3VA2... [kA]										
		100 A				160 A				250 A		
		25	40	63	100	25	40	63	100	160	160	250
Rated current	I_n [A] ¹⁾											
Circuit breaker type:	6	4.6	T	T	T	5	T	T	T	T	T	T
5SL6...-	10	3.7	T	T	T	4	T	T	T	T	T	T
Characteristic B	13	3.7	T	T	T	4	T	T	T	T	T	T
I_{cn} [kA] = 6	16	2.8	T	T	T	3.2	T	T	T	T	T	T
	20	2.7	T	T	T	3.1	T	T	T	T	T	T
	25	---	5.3	T	T	---	5.4	T	T	T	T	T
	32	---	3.5	T	T	---	3.6	T	T	T	T	T
	40	---	---	T	T	---	---	T	T	T	T	T
	50	---	---	T	T	---	---	T	T	T	T	T
	63	---	---	---	T	---	---	---	T	T	T	T
Circuit breaker type:	0.5	T	T	T	T	T	T	T	T	T	T	T
5SL6...-	1	T	T	T	T	T	T	T	T	T	T	T
Characteristic C	1.6	T	T	T	T	T	T	T	T	T	T	T
I_{cn} [kA] = 6	2	4.4	T	T	T	4.6	T	T	T	T	T	T
	3	4	T	T	T	4.3	T	T	T	T	T	T
	4	3.9	T	T	T	4.1	T	T	T	T	T	T
	6	3.9	T	T	T	4.1	T	T	T	T	T	T
	8	3.8	T	T	T	4.4	T	T	T	T	T	T
	10	3.7	T	T	T	4	T	T	T	T	T	T
	13	3.7	T	T	T	4	T	T	T	T	T	T
	16	2.8	T	T	T	3.2	T	T	T	T	T	T
	20	2.7	T	T	T	3.1	T	T	T	T	T	T
	25	---	5.3	T	T	---	5.4	T	T	T	T	T
	32	---	3.5	T	T	---	3.6	T	T	T	T	T
	40	---	---	T	T	---	---	T	T	T	T	T
	50	---	---	T	T	---	---	T	T	T	T	T
	63	---	---	---	T	---	---	---	T	T	T	T

T ≙ full selectivity up to I_{cu}/I_{cn} rated short-circuit breaking capacity of the downstream protective device.

¹⁾ In 240/415 V, 50 Hz systems, the selectivity limits are reduced by 10 %.
The selectivity limits for adjustable releases apply to the maximum value,
 I_n = rated current. I_t ≙ tripping current.

Selectivity limit values of miniature circuit breakers/molded case circuit breakers in kA

Molded case circuit breakers		Selectivity of the 5SP4... for the upstream molded case circuit breaker 3VA2... [kA]										
		100 A				160 A				250 A		
		25	40	63	100	25	40	63	100	160	160	250
Rated current	I_n [A] ¹⁾											
Circuit breaker type:	80	---	---	---	T	---	---	---	T	T	T	T
5SP4...-	100	---	---	---	---	---	---	---	---	T	T	T
Characteristic B	125	---	---	---	---	---	---	---	---	T	T	T
I_{cn} [kA] = 10												
Circuit breaker type:	80	---	---	---	T	---	---	---	T	T	T	T
5SP4...-	100	---	---	---	---	---	---	---	---	T	T	T
Characteristic C	125	---	---	---	---	---	---	---	---	T	T	T
I_{cn} [kA] = 10												
Circuit breaker type:	80	---	---	---	---	---	---	---	9	T	T	T
5SP4...-	100	---	---	---	---	---	---	---	---	T	T	T
Characteristic D												
I_{cn} [kA] = 10												

T ≙ full selectivity up to I_{cu}/I_{cn} rated short-circuit breaking capacity of the downstream protective device.

¹⁾ In 240/415 V, 50 Hz systems, the selectivity limits are reduced by 10 %.
The selectivity limits for adjustable releases apply to the maximum value,
 I_n = rated current. I_t ≙ tripping current.

Selectivity limit values of miniature circuit breakers/molded case circuit breakers in kA

Molded case circuit breakers Size Rated current		Selectivity of the 5SY4... for the upstream molded case circuit breakers 3VA2... [kA]										
		3VA2 100 A				160 A				250 A		
		25	40	63	100	25	40	63	100	160	160	250
Circuit breaker type: 5SY4...- Characteristic A I_{cn} [kA] = 10	I_n [A]	25	40	63	100	25	40	63	100	160	160	250
1	T	T	T	T	T	T	T	T	T	T	T	T
1.6	T	T	T	T	T	T	T	T	T	T	T	T
2	T	T	T	T	T	T	T	T	T	T	T	T
3	T	T	T	T	T	T	T	T	T	T	T	T
4	T	T	T	T	T	T	T	T	T	T	T	T
6	T	T	T	T	T	T	T	T	T	T	T	T
8	T	T	T	T	T	T	T	T	T	T	T	T
10	9.4	T	T	T	T	T	T	T	T	T	T	T
13	6.2	T	T	T	T	6.8	T	T	T	T	T	T
16	5.4	T	T	T	T	5.7	T	T	T	T	T	T
20	4.6	T	8	8	8	4.9	T	T	T	T	T	T
25	---	T	8	8	8	---	T	T	T	T	T	T
32	---	T	8	8	8	---	T	T	T	T	T	T
40	---	---	8	8	8	---	---	T	T	T	T	T
50	---	---	8	8	8	---	---	T	T	T	T	T
63	---	---	---	8	8	---	---	---	T	T	T	T
Circuit breaker type: 5SY4...- Characteristic B I_{cn} [kA] = 10		25	40	63	100	25	40	63	100	160	160	250
6	T	T	T	T	T	T	T	T	T	T	T	T
10	5.7	T	T	T	T	6.1	T	T	T	T	T	T
13	4.5	T	T	T	T	4.2	T	T	T	T	T	T
16	3.7	T	T	T	T	3.8	T	T	T	T	T	T
20	3.7	7.7	8	8	8	3.8	7.8	T	T	T	T	T
25	---	7.6	8	8	8	---	7.6	T	T	T	T	T
32	---	7.5	8	8	8	---	6.7	T	T	T	T	T
40	---	---	8	8	8	---	---	T	T	T	T	T
50	---	---	8	8	8	---	---	T	T	T	T	T
63	---	---	---	8	8	---	---	---	T	T	T	T
Circuit breaker type: 5SY4...- Characteristic C I_{cn} [kA] = 10		25	40	63	100	25	40	63	100	160	160	250
0.3	T	T	T	T	T	T	T	T	T	T	T	T
0.5	T	T	T	T	T	T	T	T	T	T	T	T
1	T	T	T	T	T	T	T	T	T	T	T	T
1.6	T	T	T	T	T	T	T	T	T	T	T	T
2	T	T	T	T	T	T	T	T	T	T	T	T
3	T	T	T	T	T	T	T	T	T	T	T	T
4	T	T	T	T	T	T	T	T	T	T	T	T
6	5.4	T	T	T	T	5.7	T	T	T	T	T	T
8	4.9	T	T	T	T	5.2	T	T	T	T	T	T
10	4.7	T	T	T	T	5	T	T	T	T	T	T
13	3.6	T	T	T	T	3.9	T	T	T	T	T	T
16	3.4	T	T	T	T	3.5	T	T	T	T	T	T
20	3	5.4	8	8	8	3.2	5.5	T	T	T	T	T
25	---	5.1	8	8	8	---	5.3	T	T	T	T	T
32	---	4.9	8	8	8	---	5	T	T	T	T	T
40	---	---	8	8	8	---	---	T	T	T	T	T
50	---	---	8	8	8	---	---	T	T	T	T	T
63	---	---	---	8	8	---	---	---	T	T	T	T
Circuit breaker type: 5SY4...- Characteristic D I_{cn} [kA] = 10		25	40	63	100	25	40	63	100	160	160	250
0.3	T	T	T	T	T	T	T	T	T	T	T	T
0.5	T	T	T	T	T	T	T	T	T	T	T	T
1	T	T	T	T	T	T	T	T	T	T	T	T
1.6	T	T	T	T	T	T	T	T	T	T	T	T
2	T	T	T	T	T	T	T	T	T	T	T	T
3	T	T	T	T	T	T	T	T	T	T	T	T
4	8.7	T	T	T	T	9.7	T	T	T	T	T	T
6	5.9	T	T	T	T	7.1	T	T	T	T	T	T
8	4.6	T	T	T	T	4.9	T	T	T	T	T	T
10	4	T	T	T	T	4.5	T	T	T	T	T	T
13	4.2	T	T	T	T	4.3	T	T	T	T	T	T
16	3.7	T	T	T	T	4	T	T	T	T	T	T
20	3	5.2	8	8	8	3.2	5.2	T	T	T	T	T
25	---	4.5	8	8	8	---	4.6	T	T	T	T	T
32	---	4	8	8	8	---	4.2	T	T	T	T	T
40	---	---	8	8	8	---	---	9	T	T	T	T
50	---	---	8	8	8	---	---	8.5	T	T	T	T
63	---	---	---	8	8	---	---	---	T	T	T	T

Miniature Circuit Breakers

Configuration and dimensioning

Selectivity limit values of miniature circuit breakers/molded case circuit breakers in kA

Molded case circuit breakers		Selectivity of the 5SY7... for the upstream molded case circuit breaker 3VA2... [kA]											
		3VA2 100 A					160 A					250 A	
		25	40	63	100	25	40	63	100	160	160	250	
Size	I_n [A] ¹⁾												
Rated current													
Circuit breaker type:	6	T	T	T	T	T	T	T	T	T	T	T	
5SY7...-.	10	5.7	T	T	T	6.1	T	T	T	T	T	T	
Characteristic B	13	4.5	T	T	T	4.2	T	T	T	T	T	T	
I_{cn} [kA] = 15	16	3.7	14	T	T	3.8	14	T	T	T	T	T	
	20	3.7	7.7	8	8	4.1	7.8	T	T	T	T	T	
	25	---	7.6	8	8	---	7.7	T	T	T	T	T	
	32	---	7.5	8	8	---	6.7	T	T	T	T	T	
	40	---	---	8	8	---	---	T	T	T	T	T	
	50	---	---	8	8	---	---	T	T	T	T	T	
	63	---	---	---	8	---	---	---	T	T	T	T	
Circuit breaker type:	0.3	T	T	T	T	T	T	T	T	T	T	T	
5SY7...-.	0.5	T	T	T	T	T	T	T	T	T	T	T	
Characteristic C	1	T	T	T	T	T	T	T	T	T	T	T	
I_{cn} [kA] = 15	1.6	T	T	T	T	T	T	T	T	T	T	T	
	2	T	T	T	T	T	T	T	T	T	T	T	
	3	T	T	T	T	T	T	T	T	T	T	T	
	4	8	T	T	T	T	T	T	T	T	T	T	
	6	5.4	T	T	T	5.7	T	T	T	T	T	T	
	8	4.9	T	T	T	5.2	T	T	T	T	T	T	
	10	4.7	T	T	T	5	T	T	T	T	T	T	
	13	3.6	10	T	T	3.9	10	T	T	T	T	T	
	16	3.4	8	T	T	3.5	8	T	T	T	T	T	
	20	3	5.4	8	8	3.2	5.5	T	T	T	T	T	
	25	---	5.1	8	8	---	5.3	T	T	T	T	T	
	32	---	4.9	8	8	---	5	T	T	T	T	T	
	40	---	---	8	8	---	---	T	T	T	T	T	
	50	---	---	8	8	---	---	T	T	T	T	T	
	63	---	---	---	8	---	---	---	T	T	T	T	
Circuit breaker type:	0.3	T	T	T	T	T	T	T	T	T	T	T	
5SY7...-.	0.5	T	T	T	T	T	T	T	T	T	T	T	
Characteristic D	1	T	T	T	T	T	T	T	T	T	T	T	
I_{cn} [kA] = 15	1.6	T	T	T	T	T	T	T	T	T	T	T	
	2	T	T	T	T	T	T	T	T	T	T	T	
	3	T	T	T	T	T	T	T	T	T	T	T	
	4	8.7	T	T	T	9.7	T	T	T	T	T	T	
	6	5.9	T	T	T	7.1	T	T	T	T	T	T	
	8	4.6	T	T	T	4.9	T	T	T	T	T	T	
	10	4.2	T	T	T	4.5	T	T	T	T	T	T	
	13	4	T	T	T	4.3	T	T	T	T	T	T	
	16	3.7	11	T	T	4	11	T	T	T	T	T	
	20	3	5.2	8	8	3.2	5.2	T	T	T	T	T	
	25	---	4.6	8	8	---	4.8	T	T	T	T	T	
	32	---	4	8	8	---	4.2	T	T	T	T	T	
	40	---	---	8	8	---	---	9	T	T	T	T	
	50	---	---	8	8	---	---	8.5	T	T	T	T	
	63	---	---	---	8	---	---	---	T	T	T	T	

T ≙ full selectivity up to I_{cu}/I_{cn} rated short-circuit breaking capacity of the downstream protective device.

¹⁾ In 240/415 V, 50 Hz systems, the selectivity limits are reduced by 10 %.
The selectivity limits for adjustable releases apply to the maximum value,
 I_n = rated current, I_t ≙ tripping current.

Selectivity of miniature circuit breakers/miniature circuit breakers

Within narrow limits, miniature circuit breakers also offer selectivity to each other in a fuseless distribution board. The following table shows the short-circuit current in kA up to which there is selectivity between series-connected miniature circuit breakers at 230 V AC.

This depends on the let-through peak current \hat{I} of the downstream miniature circuit breaker and on the tripping current of the upstream miniature circuit breaker.

Selectivity limit values of miniature circuit breakers/miniature circuit breakers in kA

Downstream miniature circuit breakers			Upstream miniature circuit breakers									
			5SY4...-7 Characteristic C						5SP4...-7 Characteristic C		5SP4...-8 Characteristic D	
I_n [A]	I_{cu} [kA]	I_t [A]	20	25	32	40	50	63	80	100	80	100
I_n [A] ¹⁾	I_{cn} [kA]	Selectivity limits [kA]										
5SY...-6 (without 5SY60...-6), 5SJ4...-6HG40²⁾												
Characteristic B	6	6/10/15	0.2	0.2	0.3	0.5	0.5	0.6	0.8	1.5	3	5
	10	6/10/15	0.2	0.2	0.3	0.5	0.5	0.6	0.8	1.2	3	4
	13	6/10/15	0.2	0.2	0.3	0.4	0.5	0.5	0.8	1.2	2	3
	16	6/10/15	0.2	0.2	0.3	0.4	0.5	0.5	0.8	1.2	2	3
	20	6/10/15	--	0.2	0.3	0.4	0.5	0.5	0.8	1.2	2	3
	25	6/10/15	--	--	--	0.4	0.4	0.6	0.6	1.2	1.5	3
	32	6/10/15	--	--	--	0.4	0.4	--	0.6	1.2	1.5	3
	40	6/10/15	--	--	--	--	0.4	--	0.6	1.2	1.5	2.5
	50	6/10/15	--	--	--	--	--	--	0.6	1	1.5	2.5
5SY...-7 (without 5SY60...-7), 5SJ4...-7HG...²⁾												
Characteristic C	0.5	6/10/15	0.2	0.3	0.5	0.8	0.8	0.8	1.2	4	T	T
	1	6/10/15	0.2	0.3	0.5	0.8	0.8	0.8	1.2	4	T	T
	1.5	6/10/15	0.2	0.3	0.5	0.8	0.8	0.8	1.2	4	T	T
	2	6/10/15	0.2	0.3	0.5	0.8	0.8	0.8	1.2	4	T	T
	3	6/10/15	0.2	0.2	0.3	0.5	0.5	0.8	0.8	1.5	3	4
	4	6/10/15	0.2	0.2	0.3	0.5	0.5	0.6	0.8	1.5	3	4
	6	6/10/15	0.2	0.2	0.3	0.5	0.5	0.6	0.8	1.5	3	4
	8	6/10/15	0.2	0.2	0.3	0.4	0.4	0.6	0.6	1.2	2.5	3
	10	6/10/15	0.2	0.2	0.3	0.4	0.4	0.6	0.6	1.2	2.5	3
	13	6/10/15	0.2	0.2	0.3	0.4	0.4	0.5	0.6	1.2	2	3
	16	6/10/15	0.2	0.2	0.3	0.4	0.4	0.5	0.6	1.2	2	3
	20	6/10/15	--	0.2	0.3	0.4	0.4	0.5	0.6	1.2	2	3
	25	6/10/15	--	--	--	0.3	0.4	0.5	0.6	1	1.5	2.5
	32	6/10/15	--	--	--	0.3	0.4	--	0.6	1	1.5	2.5
	40	6/10/15	--	--	--	--	--	--	0.8	0.8	1.5	2
	50	6/10/15	--	--	--	--	--	--	0.8	0.8	1.5	2
	63	6/10/15	--	--	--	--	--	--	0.8	0.8	1.2	1.5

T $\hat{=}$ full selectivity up to rated breaking capacity I_{cn} of the downstream protective device.

¹⁾ In 240/415 V, 50 Hz systems, the selectivity limits are reduced by 10 %. The selectivity limits for adjustable releases apply to the maximum value, I_n = rated current. I_t $\hat{=}$ tripping current.

²⁾ The values specified for 5SJ4...-HG... are not according to UL but are the manufacturer's specifications according to EN 60947-2 and apply for voltage U_n = 230 V ~. For available rated currents, see Catalog LV 10.

Miniature Circuit Breakers

Configuration and dimensioning

Selectivity limit values of miniature circuit breakers/miniature circuit breakers

Miniature circuit breakers		Selectivity of the 5SL4... for the upstream miniature circuit breaker 5SP4... [kA]					
		5SP4			D		
Characteristic		C					
Rated making and breaking capacity	I_{cu} [A]	10					
Rated current	I_n [A] ¹⁾	80	100	125	80	100	
Circuit breaker type:	1	T	T	T	T	T	
5SL4...-.	2	T	T	T	T	T	
Characteristic B	3	2.2	T	T	T	T	
I_{cn} [kA] = 10	4	1.2	2.6	2.9	6.6	9.7	
	6	1	2.1	2.3	4.3	6.9	
	8	0.9	1.8	2	3.3	4.6	
	10	0.9	1.6	1.7	2.8	4	
	13	0.8	1.4	1.6	2.6	3.6	
	16	0.7	1.3	1.4	2.3	3	
	20	0.7	1.2	1.3	2.1	2.8	
	25	0.7	1.1	1.2	2	2.7	
	32	0.6	1	1.1	1.8	2.4	
	40	0.6	1	1.1	1.8	2.4	
	50	0.6	1	1	1.6	2.1	
	63	0.6	0.9	1	1.5	2	
Circuit breaker type:	0.3	T	T	T	T	T	
5SL4...-.	0.5	T	T	T	T	T	
Characteristic C	1	T	T	T	T	T	
I_{cn} [kA] = 10	1.6	3.1	T	T	T	T	
	2	1.6	3.9	4.5	T	T	
	3	1.2	2.5	2.8	6	8.9	
	4	1	2.1	2.4	4.4	7	
	6	0.9	1.6	1.8	3	4.5	
	8	0.7	1.2	1.2	2	2.7	
	10	0.7	1.2	1.2	2	2.7	
	13	0.7	1.2	1.2	2	2.7	
	16	0.7	1.2	1.2	2	2.7	
	20	0.6	1	1.1	1.8	2.4	
	25	0.6	1	1.1	1.8	2.4	
	32	0.6	0.9	1	1.6	2.2	
	40	0.6	0.9	1	1.6	2.2	
	50	---	0.9	0.9	1.5	2	
	63	---	0.9	0.9	1.5	2	
Circuit breaker type:	0.3	T	T	T	T	T	
5SL4...-.	0.5	T	T	T	T	T	
Characteristic D	1	3.3	T	T	T	T	
I_{cn} [kA] = 10	1.6	1.7	4.1	4.8	T	T	
	2	1.4	2.9	3.2	7.6	T	
	3	1.1	2.2	2.4	4.5	7.2	
	4	0.9	1.8	2	3.6	5.2	
	6	0.8	1.4	1.6	2.8	3.9	
	8	0.6	1	1.1	1.8	2.4	
	10	0.6	1	1.1	1.8	2.4	
	13	0.6	1	1.1	1.8	2.4	
	16	0.6	1	1.1	1.8	2.4	
	20	0.6	0.9	1	1.6	2.2	
	25	0.6	0.9	1	1.6	2.2	
	32	0.6	0.9	1	1.7	2.3	
	40	---	0.9	---	1.5	2	
	50	---	---	---	---	1.5	
	63	---	---	---	---	1.5	

T $\hat{=}$ full selectivity up to I_{cu}/I_{cn} rated short-circuit breaking capacity of the downstream protective device.

¹⁾ In 240/415 V, 50 Hz systems, the selectivity limits are reduced by 10 %.
The selectivity limits for adjustable releases apply to the maximum value,
 I_n = rated current, I_t $\hat{=}$ tripping current.

Selectivity limit values of miniature circuit breakers/miniature circuit breakers

Miniature circuit breakers		Selectivity of the 5SL4... for the upstream miniature circuit breaker 5SY7... [kA]																	
		5SY7																	
		B																	
Rated making and breaking capacity	I_{cu} [A]	15						20						25					
Rated current	I_n [A] ¹⁾	20	25	32	40	50	63	20	25	32	40	50	63	20	25	32	40	50	63
Circuit breaker type: 5SL4...-	1	---	---	---	---	T	T	---	---	---	T	---	---	---	---	0.6	5.7	---	---
Characteristic B	2	---	---	---	---	0.5	0.7	---	---	---	0.4	---	---	---	---	---	---	---	---
I_{cn} [kA] = 10	3	---	---	---	---	---	0.4	---	---	---	---	---	---	---	---	---	---	---	---
	4	---	---	---	---	---	---	---	---	---	---	---	---	---	---	---	---	---	---
	6	---	---	---	---	---	---	---	---	---	---	---	---	---	---	---	---	---	---
	8	---	---	---	---	---	---	---	---	---	---	---	---	---	---	---	---	---	---
	10	---	---	---	---	---	---	---	---	---	---	---	---	---	---	---	---	---	---
	13	---	---	---	---	---	---	---	---	---	---	---	---	---	---	---	---	---	---
	16	---	---	---	---	---	---	---	---	---	---	---	---	---	---	---	---	---	---
	20	---	---	---	---	---	---	---	---	---	---	---	---	---	---	---	---	---	---
	25	---	---	---	---	---	---	---	---	---	---	---	---	---	---	---	---	---	---
	32	---	---	---	---	---	---	---	---	---	---	---	---	---	---	---	---	---	---
	40	---	---	---	---	---	---	---	---	---	---	---	---	---	---	---	---	---	---
	50	---	---	---	---	---	---	---	---	---	---	---	---	---	---	---	---	---	---
	63	---	---	---	---	---	---	---	---	---	---	---	---	---	---	---	---	---	---
Circuit breaker type: 5SL4...-	0.3	---	---	---	---	T	T	---	---	---	T	---	---	0.9	1.4	6.6	---	---	
Characteristic C	0.5	---	---	---	---	T	T	---	---	---	T	---	---	0.9	1.4	6.6	---	---	
I_{cn} [kA] = 10	1	---	---	---	---	1	1.2	---	---	---	0.6	---	---	---	---	---	---	---	
	1.6	---	---	---	---	0.4	0.5	---	---	---	---	---	---	---	---	---	---	---	
	2	---	---	---	---	---	0.4	---	---	---	---	---	---	---	---	---	---	---	
	3	---	---	---	---	---	---	---	---	---	---	---	---	---	---	---	---	---	
	4	---	---	---	---	---	---	---	---	---	---	---	---	---	---	---	---	---	
	6	---	---	---	---	---	---	---	---	---	---	---	---	---	---	---	---	---	
	8	---	---	---	---	---	---	---	---	---	---	---	---	---	---	---	---	---	
	10	---	---	---	---	---	---	---	---	---	---	---	---	---	---	---	---	---	
	13	---	---	---	---	---	---	---	---	---	---	---	---	---	---	---	---	---	
	16	---	---	---	---	---	---	---	---	---	---	---	---	---	---	---	---	---	
	20	---	---	---	---	---	---	---	---	---	---	---	---	---	---	---	---	---	
	25	---	---	---	---	---	---	---	---	---	---	---	---	---	---	---	---	---	
	32	---	---	---	---	---	---	---	---	---	---	---	---	---	---	---	---	---	
	40	---	---	---	---	---	---	---	---	---	---	---	---	---	---	---	---	---	
	50	---	---	---	---	---	---	---	---	---	---	---	---	---	---	---	---	---	
	63	---	---	---	---	---	---	---	---	---	---	---	---	---	---	---	---	---	
Circuit breaker type: 5SL4...-	0.3	---	---	---	---	T	T	---	---	---	T	---	---	0.6	6.4	7.2	---	---	
Characteristic D	0.5	---	---	---	---	T	T	---	---	---	T	---	---	0.6	6.4	7.2	---	---	
I_{cn} [kA] = 10	1	---	---	---	---	0.5	0.6	---	---	---	---	---	---	---	---	---	---	---	
	1.6	---	---	---	---	0.4	0.5	---	---	---	---	---	---	---	---	---	---	---	
	2	---	---	---	---	---	---	---	---	---	---	---	---	---	---	---	---	---	
	3	---	---	---	---	---	---	---	---	---	---	---	---	---	---	---	---	---	
	4	---	---	---	---	---	---	---	---	---	---	---	---	---	---	---	---	---	
	6	---	---	---	---	---	---	---	---	---	---	---	---	---	---	---	---	---	
	8	---	---	---	---	---	---	---	---	---	---	---	---	---	---	---	---	---	
	10	---	---	---	---	---	---	---	---	---	---	---	---	---	---	---	---	---	
	13	---	---	---	---	---	---	---	---	---	---	---	---	---	---	---	---	---	
	16	---	---	---	---	---	---	---	---	---	---	---	---	---	---	---	---	---	
	20	---	---	---	---	---	---	---	---	---	---	---	---	---	---	---	---	---	
	25	---	---	---	---	---	---	---	---	---	---	---	---	---	---	---	---	---	
	32	---	---	---	---	---	---	---	---	---	---	---	---	---	---	---	---	---	
	40	---	---	---	---	---	---	---	---	---	---	---	---	---	---	---	---	---	
	50	---	---	---	---	---	---	---	---	---	---	---	---	---	---	---	---	---	
	63	---	---	---	---	---	---	---	---	---	---	---	---	---	---	---	---	---	

T $\hat{=}$ full selectivity up to I_{cu}/I_{cn} rated short-circuit breaking capacity of the downstream protective device.

¹⁾ In 240/415 V, 50 Hz systems, the selectivity limits are reduced by 10 %.
The selectivity limits for adjustable releases apply to the maximum value,
 I_n = rated current, I_t $\hat{=}$ tripping current.

Miniature Circuit Breakers

Configuration and dimensioning

Selectivity limit values of miniature circuit breakers/miniature circuit breakers

Miniature circuit breakers Characteristic		Selectivity of the 5SL4... for the upstream miniature circuit breaker 5SY7... [kA]																								
		5SY7																								
		C								25																
Rated making and breaking capacity		I_{cu} [A]	15								20								25							
Rated current		I_n [A] ¹⁾	16	20	25	32	40	50	63	16	20	25	32	40	50	63	16	20	25	32	40	50	63			
Circuit breaker type:	1	---	---	---	---	---	T	T	---	---	---	---	T	---	---	---	6	T	T	T	---	---	---			
5SL4...-	2	---	---	---	---	---	1.3	2.1	---	---	---	---	1.1	---	---	---	---	---	0.5	0.5	---	---	---			
Characteristic B	3	---	---	---	---	---	0.7	0.9	---	---	---	---	0.6	---	---	---	---	---	---	---	---	---	---			
I_{cn} [kA] = 10	4	---	---	---	---	---	0.6	0.7	---	---	---	---	0.5	---	---	---	---	---	---	---	---	---	---			
	6	---	---	---	---	---	0.5	0.6	---	---	---	---	0.4	---	---	---	---	---	---	---	---	---	---			
	8	---	---	---	---	---	0.5	0.6	---	---	---	---	---	---	---	---	---	---	---	---	---	---	---			
	10	---	---	---	---	---	---	0.5	---	---	---	---	---	---	---	---	---	---	---	---	---	---	---			
	13	---	---	---	---	---	0.4	0.5	---	---	---	---	---	---	---	---	---	---	---	---	---	---	---			
	16	---	---	---	---	---	---	0.5	---	---	---	---	---	---	---	---	---	---	---	---	---	---	---			
	20	---	---	---	---	---	---	0.5	---	---	---	---	---	---	---	---	---	---	---	---	---	---	---			
	25	---	---	---	---	---	---	---	---	---	---	---	---	---	---	---	---	---	---	---	---	---	---			
	32	---	---	---	---	---	---	---	---	---	---	---	---	---	---	---	---	---	---	---	---	---	---			
	40	---	---	---	---	---	---	---	---	---	---	---	---	---	---	---	---	---	---	---	---	---	---			
	50	---	---	---	---	---	---	---	---	---	---	---	---	---	---	---	---	---	---	---	---	---	---			
	63	---	---	---	---	---	---	---	---	---	---	---	---	---	---	---	---	---	---	---	---	---	---			
Circuit breaker type:	0.3	---	---	---	---	---	T	T	---	---	---	---	T	---	---	---	6.6	T	T	T	---	---	---			
5SL4...-	0.5	---	---	---	---	---	T	T	---	---	---	---	T	---	---	---	6.6	T	T	T	---	---	---			
Characteristic C	1	---	---	---	---	---	1.7	2.4	---	---	---	---	1.4	---	---	---	---	---	0.9	1	---	---	---			
I_{cn} [kA] = 10	1.6	---	---	---	---	---	0.8	1.1	---	---	---	---	0.7	---	---	---	---	---	0.4	0.4	---	---	---			
	2	---	---	---	---	---	0.7	0.8	---	---	---	---	0.6	---	---	---	---	---	---	---	---	---	---			
	3	---	---	---	---	---	0.5	0.7	---	---	---	---	0.4	---	---	---	---	---	---	---	---	---	---			
	4	---	---	---	---	---	0.5	0.6	---	---	---	---	0.4	---	---	---	---	---	---	---	---	---	---			
	6	---	---	---	---	---	---	0.6	---	---	---	---	---	---	---	---	---	---	---	---	---	---	---			
	8	---	---	---	---	---	---	---	---	---	---	---	---	---	---	---	---	---	---	---	---	---	---			
	10	---	---	---	---	---	---	---	---	---	---	---	---	---	---	---	---	---	---	---	---	---	---			
	13	---	---	---	---	---	---	---	---	---	---	---	---	---	---	---	---	---	---	---	---	---	---			
	16	---	---	---	---	---	---	---	---	---	---	---	---	---	---	---	---	---	---	---	---	---	---			
	20	---	---	---	---	---	---	---	---	---	---	---	---	---	---	---	---	---	---	---	---	---	---			
	25	---	---	---	---	---	---	---	---	---	---	---	---	---	---	---	---	---	---	---	---	---	---			
	32	---	---	---	---	---	---	---	---	---	---	---	---	---	---	---	---	---	---	---	---	---	---			
	40	---	---	---	---	---	---	---	---	---	---	---	---	---	---	---	---	---	---	---	---	---	---			
	50	---	---	---	---	---	---	---	---	---	---	---	---	---	---	---	---	---	---	---	---	---	---			
	63	---	---	---	---	---	---	---	---	---	---	---	---	---	---	---	---	---	---	---	---	---	---			
Circuit breaker type:	0.3	---	---	---	---	---	T	T	---	---	---	---	T	---	---	---	7.4	T	T	T	---	---	---			
5SL4...-	0.5	---	---	---	---	---	T	T	---	---	---	---	T	---	---	---	7.4	T	T	T	---	---	---			
Characteristic D	1	---	---	---	---	---	1	1.3	---	---	---	---	0.8	---	---	---	---	---	0.5	0.5	---	---	---			
I_{cn} [kA] = 10	1.6	---	---	---	---	---	0.8	0.9	---	---	---	---	0.7	---	---	---	---	---	---	---	---	---	---			
	2	---	---	---	---	---	0.6	0.7	---	---	---	---	0.5	---	---	---	---	---	---	---	---	---	---			
	3	---	---	---	---	---	0.5	0.6	---	---	---	---	0.4	---	---	---	---	---	---	---	---	---	---			
	4	---	---	---	---	---	---	0.6	---	---	---	---	---	---	---	---	---	---	---	---	---	---	---			
	6	---	---	---	---	---	0.4	0.5	---	---	---	---	---	---	---	---	---	---	---	---	---	---	---			
	8	---	---	---	---	---	---	---	---	---	---	---	---	---	---	---	---	---	---	---	---	---	---			
	10	---	---	---	---	---	---	---	---	---	---	---	---	---	---	---	---	---	---	---	---	---	---			
	13	---	---	---	---	---	---	---	---	---	---	---	---	---	---	---	---	---	---	---	---	---	---			
	16	---	---	---	---	---	---	---	---	---	---	---	---	---	---	---	---	---	---	---	---	---	---			
	20	---	---	---	---	---	---	---	---	---	---	---	---	---	---	---	---	---	---	---	---	---	---			
	25	---	---	---	---	---	---	---	---	---	---	---	---	---	---	---	---	---	---	---	---	---	---			
	32	---	---	---	---	---	---	---	---	---	---	---	---	---	---	---	---	---	---	---	---	---	---			
	40	---	---	---	---	---	---	---	---	---	---	---	---	---	---	---	---	---	---	---	---	---	---			
	50	---	---	---	---	---	---	---	---	---	---	---	---	---	---	---	---	---	---	---	---	---	---			
	63	---	---	---	---	---	---	---	---	---	---	---	---	---	---	---	---	---	---	---	---	---	---			

T ≙ full selectivity up to I_{cu}/I_{cn} rated short-circuit breaking capacity of the downstream protective device.

¹⁾ In 240/415 V, 50 Hz systems, the selectivity limits are reduced by 10 %.
The selectivity limits for adjustable releases apply to the maximum value,
 I_n = rated current. I_t ≙ tripping current.

Miniature Circuit Breakers

Configuration and dimensioning

Selectivity limit values of miniature circuit breakers/miniature circuit breakers

Miniature circuit breakers		Selectivity of the 5SL6... for the upstream miniature circuit breaker 5SP4... [kA]					
		5SP4			D		
Characteristic		C					
Rated making and breaking capacity	I_{cu} [A]	10					
Rated current	I_n [A] ¹⁾	80	100	125	80	100	
Circuit breaker type:	6	1	1.3	1.4	2	3	
5SL6...-	10	1	1.2	1.3	2	2.7	
Characteristic B	13	1	1.2	1.3	2	2.7	
I_{cn} [kA] = 6	16	1	1	1.1	2	2.3	
	20	1	1	1.1	2	2.3	
	25	1	1	1.1	2	2.2	
	32	1	1	1.1	2	2.1	
	40	1	1.1	1.1	2	2.3	
	50	1	1	1	2	2	
	63	---	0.9	1	1	1.9	
Circuit breaker type:	0.5	T	T	T	T	T	
5SL6...-	1	T	T	T	T	T	
Characteristic C	1.6	1	3.5	4.4	T	T	
I_{cn} [kA] = 6	2	1	2.2	2.4	4	T	
	3	1	1.8	2	2	4.9	
	4	1	1.7	1.9	3	4.7	
	6	1	1.7	1.9	3	4.7	
	8	1	1.2	1.3	2	2.8	
	10	1	1.2	1.3	2	2.7	
	13	1	1.2	1.3	2	2.7	
	16	1	1	1.1	2	2.3	
	20	1	1	1.1	2	2.3	
	25	1	1	1.1	2	2.2	
	32	1	1	1.1	2	2.1	
	40	1	1.1	1.1	2	2.3	
	50	1	1	1	2	2	
	63	---	0.9	1	1	1.9	

T ≙ full selectivity up to I_{cu}/I_{cn} rated short-circuit breaking capacity of the downstream protective device.

¹⁾ In 240/415 V, 50 Hz systems, the selectivity limits are reduced by 10 %.
The selectivity limits for adjustable releases apply to the maximum value,
 I_n = rated current. I_t ≙ tripping current.

Selectivity limit values of miniature circuit breakers/miniature circuit breakers

Miniature circuit breakers		Selectivity of the 5SL6... for the upstream miniature circuit breaker 5SY7... [kA]																				
		5SY7								C								D				
		B																				
Rated making and breaking capacity	I_{cu} [A]	15	20	25					15	20	25					15	20	25				
Rated current	I_n [A] ¹⁾	50	63	40	16	20	25	32	50	63	40	16	20	25	32	50	63	40	16	20	25	32
Circuit breaker type:	6	0.2	0.3	0.2	---	0.1	0.1	0.1	0.4	0.5	0.3	0.1	0.2	0.2	0.2	1.1	1.3	0.9	0.3	0.3	0.4	0.6
5SL6...-	10	0.2	0.3	0.2	---	0.1	0.1	0.1	0.4	0.5	0.3	0.1	0.2	0.2	0.2	1	1.2	0.8	0.3	0.3	0.4	0.6
Characteristic B	13	---	0.3	---	---	---	---	---	0.4	0.5	0.3	---	---	---	---	1	1.2	0.8	0.3	0.3	0.4	0.5
I_{cn} [kA] = 6	16	---	---	---	---	---	---	---	0.4	0.4	0.3	---	---	---	---	0.9	1	0.7	---	0.3	0.4	0.5
	20	---	---	---	---	---	---	---	0.4	0.4	0.3	---	---	---	---	0.9	1	0.7	---	---	0.3	0.5
	25	---	---	---	---	---	---	---	0.4	0.4	0.3	---	---	---	---	0.9	1	0.7	---	---	---	0.5
	32	---	---	---	---	---	---	---	0.4	0.4	0.3	---	---	---	---	0.9	1.1	0.7	---	---	---	---
	40	---	---	---	---	---	---	---	---	---	---	---	---	---	---	0.9	1.1	---	---	---	---	---
	50	---	---	---	---	---	---	---	---	---	---	---	---	---	---	1	---	---	---	---	---	---
	63	---	---	---	---	---	---	---	---	---	---	---	---	---	---	---	---	---	---	---	---	---
Circuit breaker type:	0.5	1.8	2.4	1.3	0.2	0.4	0.5	0.8	T	T	4	0.7	1.1	1.5	1.6	T	T	T	2.7	3.1	T	T
5SL6...-	1	0.8	0.9	0.6	0.1	0.2	0.3	0.4	1.3	2.2	1.1	0.4	0.5	0.7	0.7	T	T	T	0.9	1	1.3	2.9
Characteristic C	1.6	0.4	0.4	0.3	0.1	0.1	0.2	0.2	0.7	0.9	0.6	0.2	0.3	0.4	0.4	2.3	3.3	1.5	0.5	0.5	0.7	1
I_{cn} [kA] = 6	2	0.3	0.4	0.3	0.1	0.1	0.1	0.2	0.6	0.8	0.5	0.2	0.2	0.3	0.3	1.6	2.1	1.2	0.4	0.4	0.6	0.9
	3	0.3	0.3	0.2	---	0.1	0.1	0.2	0.5	0.7	0.4	0.2	0.2	0.3	0.3	1.4	1.8	1.1	0.4	0.4	0.5	0.8
	4	0.3	0.3	0.2	---	0.1	0.1	0.2	0.5	0.7	0.4	0.2	0.2	0.3	0.3	1.3	1.7	1.1	0.4	0.4	0.5	0.8
	6	0.3	0.3	0.2	---	0.1	0.1	0.2	0.5	0.7	0.4	0.2	0.2	0.3	0.3	1.3	1.7	1.1	0.4	0.4	0.5	0.8
	8	0.2	0.3	0.2	---	0.1	0.1	0.1	0.4	0.5	0.3	0.1	0.2	0.2	0.2	1	1.2	0.8	0.3	0.3	0.4	0.6
	10	0.2	0.3	0.2	---	0.1	0.1	0.1	0.4	0.5	0.3	0.1	0.2	0.2	0.2	1	1.2	0.8	0.3	0.3	0.4	0.6
	13	---	0.3	---	---	---	---	---	0.4	0.5	0.3	---	---	---	---	1	1.2	0.8	0.3	0.3	0.4	0.5
	16	---	---	---	---	---	---	---	0.4	0.4	0.3	---	---	---	---	0.9	1	0.7	---	0.3	0.4	0.5
	20	---	---	---	---	---	---	---	0.4	0.4	0.3	---	---	---	---	0.9	1	0.7	---	---	0.3	0.5
	25	---	---	---	---	---	---	---	0.4	0.4	0.3	---	---	---	---	0.9	1	0.7	---	---	---	0.5
	32	---	---	---	---	---	---	---	0.4	0.4	0.3	---	---	---	---	0.9	1.1	0.7	---	---	---	---
	40	---	---	---	---	---	---	---	---	---	---	---	---	---	---	0.9	1.1	---	---	---	---	---
	50	---	---	---	---	---	---	---	---	---	---	---	---	---	---	1	---	---	---	---	---	---
	63	---	---	---	---	---	---	---	---	---	---	---	---	---	---	---	---	---	---	---	---	---

T $\hat{=}$ full selectivity up to I_{cu}/I_{cn} rated short-circuit breaking capacity of the downstream protective device.

¹⁾ In 240/415 V, 50 Hz systems, the selectivity limits are reduced by 10 %.
The selectivity limits for adjustable releases apply to the maximum value,
 I_n = rated current. I_t $\hat{=}$ tripping current.

Miniature Circuit Breakers

Configuration and dimensioning

Back-up protection of miniature circuit breakers/fuses

If the maximum short-circuit current of the miniature circuit breaker at the installation location is unknown, or if the specified rated switching capacity is exceeded, an additional protective device must be connected upstream as back-up protection to prevent overloading of the miniature circuit breaker. This is usually a fuse.

The following table shows the short-circuit currents – in kA – up to which back-up protection is guaranteed when using fuses according to DIN VDE 0636-2 and DIN VDE 0636-3.

Back-up protection limit values of miniature circuit breakers/fuses in kA

Downstream miniature circuit breakers	I_n [A] ¹⁾	Upstream fuse						
		50 A	63 A	80 A	100 A	125 A	160 A	>160 A
5SY6 (without 5SY60)								
	0.3 ... 4	No back-up protection required ¹⁾						
	6	50	50	50	50	50	35	30
	8	50	50	50	50	50	35	15
	10	50	50	50	50	50	35	15
	13	50	50	50	35	35	30	15
	16	50	50	50	35	30	30	15
	20	50	50	50	35	25	25	15
	25	50	50	50	35	30	25	15
	32	50	50	50	35	30	25	15
	40	50	50	50	50	25	15	10
	50	50	50	50	50	25	15	10
	63	50	50	35	25	25	15	10
5SY4, 5SY7, 5SY8, 5SJ4...-HG..²⁾								
	0.3 ... 6	No back-up protection required ¹⁾						
	8	50	50	50	50	45	45	40
	10	50	50	50	50	45	45	40
	13	50	50	50	45	40	35	30
	16	50	50	50	45	40	35	30
	20	50	50	50	40	35	30	30
	25	50	50	50	40	35	30	30
	32	50	50	50	45	40	30	30
	40	50	50	50	45	40	30	20
	50	50	50	50	40	35	25	20
	63	50	50	45	40	35	25	20

Test circuit data:

$U_0 = 250$ V
P.f. = 0.3 ... 0.5

Test cycle:

Acc. to EN 60947-2 (0 - C0)

¹⁾ Up to the respective I_{cu} according to the table "Rated switching capacity" on page 28.

²⁾ The values specified for 5SJ4...-HG.. are not according to UL but are the manufacturer's specifications according to EN 60947-2 and apply for voltage $U_e = 230$ V ~. For available rated currents, see Catalog LV 10.

Back-up protection limit values of miniature circuit breakers/fuses in kA

Fuse		Upstream fuses 3NA..., 5SB4..., 5SE2... [kA]					
		3NA		5SB4		5SE2	
Operational class		gG		gG		gG	
Size		2		DIII		D02	
Rated breaking capacity	I_{cu} [AC kA]	120		50		50	
Rated voltage	U_b [AC V]	500		500		400	
Rated current	I_n [A]	50	63	50	63	50	63
Circuit breaker type:	1	50	50	50	50	50	50
5SL4...-.	2	50	50	50	50	50	50
Characteristic B	3	50	50	50	50	50	50
I_{cn} [kA] = 10	4	50	50	50	50	50	50
	6	50	50	50	50	50	50
	8	50	50	50	50	50	50
	10	50	50	50	50	50	50
	13	50	50	50	50	50	50
	16	50	50	50	50	50	50
	20	50	50	50	50	50	50
	25	50	50	50	50	50	50
	32	50	50	50	50	50	50
	40	--	50	--	50	--	50
Circuit breaker type:	0.3	50	50	50	50	50	50
5SL4...-.	0.5	50	50	50	50	50	50
Characteristic C/D	1	50	50	50	50	50	50
I_{cn} [kA] = 10	1.6	50	50	50	50	50	50
	2	50	50	50	50	50	50
	3	50	50	50	50	50	50
	4	50	50	50	50	50	50
	6	50	50	50	50	50	50
	8	50	50	50	50	50	50
	10	50	50	50	50	50	50
	13	50	50	50	50	50	50
	16	50	50	50	50	50	50
	20	50	50	50	50	50	50
	25	50	50	50	50	50	50
	32	50	50	50	50	50	50
	40	--	50	--	50	--	50

Miniature Circuit Breakers

Configuration and dimensioning

Back-up protection limit values of miniature circuit breakers/fuses in kA

		Upstream fuse 3NA... [kA]			
		3NA			
		gG			
		2			
Rated breaking capacity	I_{cu} [AC kA]	120			
Rated voltage	U_b [AC V]	500			
Rated current	I_n [A]	63	80	100	125
Circuit breaker type:					
5SL6...-	6	30	30	10	10
	10	30	30	10	10
Characteristic B	13	30	30	15	15
I_{cn} [kA] = 6	16	30	30	15	15
	20	30	30	20	15
	25	30	30	25	20
	32	30	30	25	25
Circuit breaker type:					
5SL6...-	0.3	30	30	25	10
	0.5	30	30	25	10
Characteristic C	1	30	30	25	10
I_{cn} [kA] = 6	1.6	30	30	25	10
	2	30	30	25	10
	3	30	30	25	10
	4	30	30	25	10
	6	30	30	20	20
	8	30	30	25	20
	10	30	30	25	20
	13	30	30	25	20
	16	30	30	25	20
	20	30	30	25	20
	25	30	30	25	20
	32	30	30	25	25

Back-up protection of miniature circuit breakers/molded case circuit breakers

If miniature circuit breakers are installed in fuseless distribution boards, molded case circuit breakers according to IEC/EN 60947-2 must be used as back-up protection.

The following tables show the short-circuit currents – in kA – up to which back-up protection is guaranteed when using molded case circuit breakers.

Back-up protection limit values of miniature circuit breakers/molded case circuit breakers in kA

Downstream miniature circuit breakers	Upstream molded case circuit breakers																		
	3VL1 Non-adjustable									3VL2 Adjustable									
I_n [A]	16	20	25	32	40	50	63	80	100	125	160	50	63	80	100	125	160		
I_t [A]	160	200	250	320	400	500	630	800	1000	1250	1600	400	500	630	800	1000	1280		
I_{cu} [kA]	40/70	40/70	40/70	40/70	40/70	40/70	40/70	40/70	40/70	40/70	40/70	55/70/100	55/70/100	55/70/100	55/70/100	55/70/100	55/70/100		
I_n [A] I_{cn} [kA]	Back-up protection up to kA																		
5SY6 (without 5SY60)																			
Characteristic B, C	0.3 ... 6	6	35	35	35	35	35	35	35	35	35	35	35	35	35	35	35	35	35
	8 ... 32	6	25	25	25	25	25	25	25	25	25	25	25	25	25	25	25	25	25
	40 ... 63	6	20	20	20	20	20	20	20	20	20	20	20	20	20	20	20	20	20
5SY4, 5SJ4...-HG..¹⁾																			
Characteristic A, B, C, D	0.3 ... 6	10	40	40	40	40	40	40	40	40	40	40	40	40	40	40	40	40	40
	8 ... 32	10	30	30	30	30	30	30	30	30	30	30	30	30	30	30	30	30	30
	40 ... 63	10	25	25	25	25	25	25	25	25	25	25	25	25	25	25	25	25	25
5SY7																			
Characteristic B, C	0.3 ... 2	15	50	50	50	50	50	50	50	50	50	50	50	50	50	50	50	50	50
	3 ... 10	15	45	45	45	45	45	45	45	45	45	45	45	45	45	45	45	45	45
	13 ... 32	15	40	40	40	40	40	40	40	40	40	40	40	40	40	40	40	40	40
	40 ... 63	15	35	35	35	35	35	35	35	35	35	35	35	35	35	35	35	35	35
Characteristic D	0.3 ... 2	15	50	50	50	50	50	50	50	50	50	50	50	50	50	50	50	50	50
	3 ... 10	15	45	45	45	45	45	45	45	45	45	45	45	45	45	45	45	45	45
	13 ... 32	15	40	40	40	40	40	40	40	40	40	40	40	40	40	40	40	40	40
	40 ... 63	15	35	35	35	35	35	35	35	35	35	35	35	35	35	35	35	35	35
5SY8																			
Characteristic C	0.3 ... 2	25	70	70	70	70	70	70	70	70	70	70	70	70	70	70	70	70	70
	3 ... 6	25	50	50	50	50	50	50	50	50	50	50	50	50	50	50	50	50	50
	8 ... 32	25	45	45	45	45	45	45	45	45	45	45	45	45	45	45	45	45	45
	40 ... 63	25	40	40	40	40	40	40	40	40	40	40	40	40	40	40	40	40	40
Characteristic D	0.3 ... 2	25	70	70	70	70	70	70	70	70	70	70	70	70	70	70	70	70	70
	3 ... 6	25	50	50	50	50	50	50	50	50	50	50	50	50	50	50	50	50	50
	8 ... 32	25	45	45	45	45	45	45	45	45	45	45	45	45	45	45	45	45	45
	40 ... 63	25	40	40	40	40	40	40	40	40	40	40	40	40	40	40	40	40	40
5SP4																			
Characteristic B, C	80 ... 125	10	25	25	25	25	25	25	25	25	25	25	25	25	25	25	25	25	25
Characteristic D	80 to 100	10	20	20	20	20	20	20	20	20	20	20	20	20	20	20	20	20	20

¹⁾ The values specified for 5SJ4...-HG.. are not according to UL but are the manufacturer's specifications according to EN 60947-2 and apply for voltage $U_n = 230\text{ V } \sim$. For available rated currents, see Catalog LV 10.

Miniature Circuit Breakers

Configuration and dimensioning

Downstream miniature circuit breakers		Upstream molded case circuit breakers													
		3VL3		3VL4				3VL5				3VL6	3VL7	3VL8	
I_n [A]		200	250	200	250	315	400	250 ... 315	315 ... 400	400 ... 500	500 ... 630	320 ... 800	400 ... 1250	1600 ... 2000	
I_i [A]		2000	2500	2000	2500	3150	4000	2500 ... 3150	3150 ... 4000	4000 ... 5000	5000 ... 6300	3200 ... 6300	15000	20000	
I_{cn} [kA]		55/70/100	55/70/100	55/70/100	55/70/100	55/70/100	55/70/100	55/70/100	55/70/100	55/70/100	55/70/100	55/70/100	55/70/100	70/100	
I_n [A]	I_{cn} [kA]	Back-up protection up to kA													
5SY6 (without 5SY60)															
Characteristic B, C	0.3 ... 6	6	35	35	35	35	35	35	35	35	35	35	35	35	35
	8 ... 32	6	25	25	25	25	25	25	25	25	25	25	25	25	25
	40 ... 63	6	20	20	20	20	20	20	20	20	20	20	20	20	20
5SY4, 5SJ4...-HG..¹⁾															
Characteristic A, B, C, D	0.3 ... 6	10	40	40	40	40	40	40	40	40	40	40	40	40	40
	8 ... 32	10	30	30	30	30	30	30	30	30	30	30	30	30	
	40 ... 63	10	25	25	25	25	25	25	25	25	25	25	25	25	
5SY7															
Characteristic B, C	0.3 ... 2	15	50	50	50	50	50	50	50	50	50	50	50	50	50
	3 ... 10	15	45	45	45	45	45	45	45	45	45	45	45	45	
	13 ... 32	15	40	40	40	40	40	40	40	40	40	40	40	40	
	40 ... 63	15	35	35	35	35	35	35	35	35	35	35	35	35	
Characteristic D	0.3 ... 2	15	50	50	50	50	50	50	50	50	50	50	50	50	
	3 ... 10	15	45	45	45	45	45	45	45	45	45	45	45		
	13 ... 32	15	40	40	40	40	40	40	40	40	40	40	40		
	40	15	35	35	35	35	35	35	35	35	35	35	35		
	50 ... 63	15	30	30	30	30	30	30	30	30	30	30	30		
5SY8															
Characteristic C	0.3 ... 2	25	70	70	70	70	70	70	70	70	70	70	70	--	--
	3 ... 6	25	50	50	50	50	50	50	50	50	50	50	50	--	--
	8 ... 32	25	45	45	45	45	45	45	45	45	45	45	45	--	--
	40 ... 63	25	40	40	40	40	40	40	40	40	40	40	40	--	--
Characteristic D	0.3 ... 2	25	70	70	70	70	70	70	70	70	70	70	70	--	--
	3 ... 6	25	50	50	50	50	50	50	50	50	50	50	50	--	--
	8 ... 32	25	45	45	45	45	45	45	45	45	45	45	45	--	--
	40	25	40	40	40	40	40	40	40	40	40	40	40	--	--
	50 ... 63	25	35	35	35	35	35	35	35	35	35	35	35	--	--
5SP4															
Characteristic B, C	80 ... 125	10	25	25	25	25	25	25	25	25	25	25	25	--	--
	80 to 100	10	20	20	20	20	20	20	20	20	20	20	20	--	--

¹⁾ The values specified for 5SJ4...-HG.. are not according to UL but are the manufacturer's specifications according to EN 60947-2 and apply for voltage $U_e = 230\text{ V} \sim$. For available rated currents, see Catalog LV 10.

Back-up protection limit values of miniature circuit breakers/molded case circuit breakers in kA

		Upstream molded case circuit breaker 3VA2... [kA]											
		3VA2				160 A				250 A			
Molded case circuit breakers		ETU320, ETU330, ETU340, ETU350, ETU550, ETU560											
Size		100 A				160 A				250 A			
Releases		ETU320, ETU330, ETU340, ETU350, ETU550, ETU560											
Rated current	I_n [A]	25	40	63	100	25	40	63	100	160	160	250	
Circuit breaker type: 5SL4...-	1	25	25	25	25	25	25	25	25	25	25	25	
	2	25	25	25	25	25	25	25	25	25	25	25	
	Characteristic B	3	25	25	25	25	25	25	25	25	25	25	
	I_{cn} [kA] = 10	4	25	25	25	25	25	25	25	25	25	25	25
		6	25	25	25	25	25	25	25	25	25	25	25
		8	20	20	20	20	20	20	20	20	20	20	20
		10	20	20	20	20	20	20	20	20	20	20	20
		13	15	15	15	15	15	15	15	15	15	15	15
		16	15	15	15	15	15	15	15	15	15	15	15
		20	--	25	25	25	--	25	25	25	25	25	25
	25	--	25	25	25	--	25	25	25	25	25	25	
	32	--	--	25	25	--	--	25	25	25	25	25	
	40	--	--	10	10	--	--	10	10	10	10	10	
Circuit breaker type: 5SL4...-	0.3	25	25	25	25	25	25	25	25	25	25	25	
	0.5	25	25	25	25	25	25	25	25	25	25	25	
	Characteristic C/D	1	25	25	25	25	25	25	25	25	25	25	
	I_{cn} [kA] = 10	1.6	25	25	25	25	25	25	25	25	25	25	25
		2	25	25	25	25	25	25	25	25	25	25	25
		3	25	25	25	25	25	25	25	25	25	25	25
		4	25	25	25	25	25	25	25	25	25	25	25
		6	25	25	25	25	25	25	25	25	25	25	25
		8	20	20	20	20	20	20	20	20	20	20	20
		10	10	10	10	10	10	10	10	10	10	10	10
		13	15	15	15	15	15	15	15	15	15	15	15
		16	25	25	25	25	25	25	25	25	25	25	25
		20	--	25	25	25	--	25	25	25	25	25	25
		25	--	25	25	25	--	25	25	25	25	25	25
		32	--	--	25	25	--	--	25	25	25	25	25
		40	--	--	10	10	--	--	10	10	10	10	10

Miniature Circuit Breakers

Configuration and dimensioning

Internal resistance and power loss

Internal resistance R_i and power loss P_v of 5SL3, 5SL6 miniature circuit breakers
(data per pole with I_n)

I_n A	Characteristic B		Characteristic C	
	R_i mΩ	P_v W	R_i mΩ	P_v W
5SL3, 5SL6				
0.3	--	--	10500	0.9
0.5	--	--	3400	0.9
1	--	--	1210	1.2
1.6	--	--	459	1.2
2	--	--	295	1.2
3	--	--	137	1.2
4	--	--	81	1.3
6	23.3	0.8	17.1	0.6
8	--	--	10.9	0.7
10	14.9	1.5	12.1	1.2
13	11.0	1.9	10.6	1.8
16	7.6	1.9	6.6	1.7
20	5.2	2.1	5.1	2.0
25	4.0	2.5	3.7	2.3
32	2.3	2.4	2.4	2.5
40	2.1	3.4	2.1	3.3
50	1.5	3.8	1.4	3.5
63	1.4	5.4	1.1	4.4

Internal resistance R_i and power loss P_v of 5SL4 miniature circuit breakers
(data per pole with I_n)

I_n A	Characteristic B		Characteristic C		Characteristic D	
	R_i mΩ	P_v W	R_i mΩ	P_v W	R_i mΩ	P_v W
5SL4						
0.3	--	--	10151	0.9	10151	0.9
0.5	--	--	3551	0.9	3551	0.9
1	1954	2.0	1172	1.2	1089	1.1
1.6	--	--	510	1.3	466	1.2
2	461	1.8	297	1.2	273	1.1
3	216	1.9	127	1.1	124	1.1
4	98	1.6	76	1.2	68	1.1
6	52	1.9	43	1.6	39	1.4
8	22	1.4	11.9	0.8	11.8	0.8
10	19.3	1.9	9.1	0.9	8.6	0.9
13	12.3	2.1	9.1	1.5	8.2	1.4
16	7.1	1.8	6.0	1.5	4.8	1.2
20	6.1	2.5	5.0	2.0	4.1	1.6
25	4.8	3.0	3.7	2.3	3.7	2.3
32	2.6	2.7	2.6	2.6	2.6	2.7
40	2.2	3.4	2.1	3.3	2.1	3.3
50	1.6	4.0	1.4	3.6	1.4	3.6
63	1.3	5.0	1.3	5.0	1.3	5.0

Internal resistance R_i and power loss P_v of 5SY4, 5SY6, 5SY7, 5SY8, 5SY5 and 5SP4 miniature circuit breakers
(data per pole with I_n)

I_n A	Characteristic A		Characteristic B		Characteristic C		Characteristic D		
	R_i mΩ	P_v W	R_i mΩ	P_v W	R_i mΩ	P_v W	R_i mΩ	P_v W	
5SY4, 5SY6 (without 5SY60), 5SY7, 5SY8, 5SY5									
0.3	--	--	--	--	10270	0.9	10070	1	
0.5	7600	1.9	--	--	3300	0.8	3100	0.8	
1	2080	2.1	--	--	1200	1.2	1075	1.1	
1.6	831	2.1	--	--	450	1.2	408	1.0	
2	546	2.2	381	1.5	298	1.2	295	1.2	
2.5	--	--	--	--	230	1.4	--	--	
3	213	1.9	--	--	138	1.3	132	1.2	
3.5	--	--	--	--	135	1.7	--	--	
4	144	2.3	93	1.5	81	1.3	74	1.2	
5	--	--	--	--	87	2.2	--	--	
6	60	2.2	58	2.1	45	1.6	44	1.6	
8	29.3	1.9	--	--	14	0.9	12	0.8	
10	19.5	2.0	13	1.3	11	1.0	8.5	0.9	
13	11.7	2.0	9.9	1.7	8.3	1.4	8.3	1.4	
15	--	--	--	--	6.5	1.5	--	--	
16	9.6	2.5	6.9	1.8	6.3	1.6	6.2	1.6	
20	6.2	2.5	5.5	2.2	4.3	1.7	4.0	1.6	
25	5.2	3.3	3.8	2.4	3.5	2.2	3.3	2.1	
30	--	--	--	--	2.6	2.3	--	--	
32	3.3	3.4	2.5	2.6	2.6	2.6	2.1	2.1	
35	--	--	--	--	2.1	2.6	--	--	
40	2.4	3.9	2.2	3.6	2.2	3.5	1.9	3.0	
45	--	--	--	--	1.5	3.1	--	--	
50	1.8	4.5	1.7	4.3	1.5	3.8	1.5	3.7	
60	--	--	--	--	1.2	4.4	--	--	
63	1.5	6.0	1.5	6.0	1.2	4.9	1.3	5.0	
80	--	--	1.05	6.7	1.05	6.7	--	--	
5SP4									
80	--	--	1.1	7.0	1.1	6.7	1.1	6.7	
100	--	--	0.8	8.0	0.88	8	0.8	8	
125	--	--	0.7	10.1	0.7	10.8	--	--	

Correction factors for power loss

- Direct current and alternating current up to 60 Hz × 1.0
- Alternating current
 - 200 Hz × 1.1
 - 400 Hz × 1.15
 - 1000 Hz × 1.3

Internal resistance R_i and power loss P_v of 5SY30, 5SY60 miniature circuit breakers, compact range 1+N in 1 MW
(data per pole with I_n)

I_n A	Characteristic B				Characteristic C				
	Phase-pole		N pole		Phase-pole		N pole		
	R_i mΩ	P_v W	R_i mΩ	P_v W	R_i mΩ	P_v W	R_i mΩ	P_v W	
5SY30, 5SY60									
2	--	--	--	--	291	1.2	3.7	0.01	
4	--	--	--	--	126	2.0	4.1	0.07	
6	32	1.1	4.2	0.2	26	0.9	4.3	0.2	
8	--	--	--	--	20	1.3	4.0	0.3	
10	16	1.6	4.2	0.4	13	1.3	4.3	0.4	
13	9.9	1.7	4.2	0.7	9.5	1.6	4.5	0.8	
16	9.1	2.3	4.2	1.1	8.1	2.1	3.4	0.9	
20	5.6	2.2	1.1	0.4	5.7	2.3	1.2	0.5	
25	3.5	2.2	1.1	0.7	3.3	2.1	1.1	0.7	
32	2.7	2.8	1.1	1.2	2.8	2.8	1.2	1.2	
40	2.5	4.0	1.1	1.8	2.4	3.8	1.1	1.8	

Miniature Circuit Breakers

Configuration and dimensioning

Personnel safety with miniature circuit breakers

According to DIN VDE 0100-410, in order to protect against dangerous leakage currents in the TN system, the cross-sections of the conductor, or its distance from the protective device, must be dimensioned such that if a fault with negligible impedance (i.e. short circuit) occurs at any point between a phase conductor and a PE conductor, or a connected exposed conductive part, the device automatically trips within the specified times of 0.4 s/5 s.

This requirement is met through the following condition:

$$Z_s \times I_a \leq U_0$$

Z_s ≙ Impedance of the fault loop of all electrical circuits

I_a ≙ Current that trips within the specified times

U_0 ≙ Voltage to ground

Maximum permissible impedance of fault loop at $U_0 = 230$ V AC for compliance with trip conditions according to DIN VDE 0100-410

I_n A	Characteristic A		Characteristic B		Characteristic C		Characteristic D	
	$t_a \leq 0.4$ s	≤ 5 s	$t_a \leq 0.4$ s	≤ 5 s	$t_a \leq 0.4$ s	≤ 5 s	$t_a \leq 0.4$ s	≤ 5 s
	Ω	Ω	Ω	Ω	Ω	Ω	Ω	Ω
5SL, 5SY, 5SP								
0.3	--	--	--	--	76.6	153	--	--
0.5	--	--	--	--	46	92	--	92
1.0	76.6	76.6	--	--	23	46	15.3	46
1.6	47.9	47.9	--	--	14.4	28.8	9.6	28.8
2	38.3	38.3	--	--	11.5	23	7.6	23
3	25.5	25.5	--	--	7.7	15.4	5.1	15.4
4	19.1	19.1	--	--	5.8	11.6	3.8	11.6
6	12.7	12.7	7.6	7.6	3.8	7.6	2.5	7.6
8	--	--	--	--	2.8	5.7	1.9	5.7
10	7.6	7.6	4.6	4.6	2.3	4.6	1.1	4.6
13	--	--	--	3.57	1.7	3.4	0.9	3.4
16	4.7	4.7	2.9	2.9	1.4	2.8	0.7	2.8
20	3.8	3.8	2.3	2.3	1.1	2.2	0.5	2.2
25	3.0	3.0	1.8	1.8	0.9	1.8	0.4	1.8
32	2.4	2.4	1.4	1.4	0.7	1.4	0.3	1.4
40	1.9	1.9	1.1	1.1	0.6	1.2	0.28	1.2
50	--	--	0.9	0.9	0.5	1.0	0.23	1.0
63	--	--	0.7	0.7	0.4	0.8	0.2	0.8
80	--	--	--	--	0.3	0.6	0.14	0.6
100	--	--	--	--	0.2	0.4	0.1	0.4
125	--	--	--	--	0.16	0.3	0.1	0.3

At $U_0 = 240$ V AC, $Z_s \times 1.04$ applies.

At $U_0 = 127$ V AC, $Z_s \times 0.55$ applies.

Fuse protection of luminaire circuits

Maximum permissible lamp load of a miniature circuit breaker when operating fluorescent lamps L 18 W, L 36 W, L 38 W, L 58 W.

Maximum number of fluorescent lamps

I_n [A]	Lamp	Electronic ballast											
		Full switching at 230 V 1 lamp ¹⁾			Group switching at 230 V 1 lamp ²⁾								
		2 lamps		2 lamps		2 lamps		2 lamps		2 lamps		2 lamps	
5SY4, 5SY6 (without 5SY60), 5SY7, 5SY8, 5SY5													
Characteristic		B	C	D	B	C	D	B	C	D	B	C	D
6	L 18 W	17	37	66	17	35	35	66	66	66	35	35	35
	L 36 W	17	37	37	17	19	19	37	37	37	19	19	19
	L 58 W	17	19	19	12	12	12	19	19	19	12	12	12
8	L 18 W	--	50	88	--	47	47	--	88	88	--	--	47
	L 36 W	--	50	50	--	25	25	--	50	50	--	25	25
	L 58 W	--	25	25	--	16	16	--	25	25	--	16	16
10	L 18 W	36	67	111	36	58	58	111	111	111	58	58	58
	L 36 W	36	62	62	32	32	32	62	62	62	32	32	32
	L 58 W	32	32	32	20	20	20	32	32	32	20	20	20
13	L 18 W	44	81	144	44	76	76	144	144	144	76	76	76
	L 36 W	44	81	81	41	41	41	81	81	81	41	41	41
	L 58 W	41	41	41	26	26	26	41	41	41	26	26	26
16	L 18 W	56	100	177	56	94	94	177	177	177	94	94	94
	L 36 W	56	100	100	51	51	51	100	100	100	51	51	51
	L 58 W	51	51	51	32	32	32	51	51	51	32	32	32
20	L 18 W	70	117	222	70	117	117	222	222	222	117	117	117
	L 36 W	70	117	125	64	64	64	125	125	125	64	64	64
	L 58 W	64	64	64	40	40	40	64	64	64	40	40	40
25	L 18 W	85	157	277	85	147	147	277	277	277	147	147	147
	L 36 W	85	156	156	80	80	80	156	156	156	80	80	80
	L 58 W	80	80	80	51	51	51	80	80	80	51	51	51
32	L 18 W	100	144	355	100	144	188	355	355	355	188	188	188
	L 36 W	100	144	200	100	103	103	200	200	200	103	103	103
	L 58 W	100	103	103	65	65	65	103	103	103	65	65	65
40	L 18 W	126	216	444	126	216	235	444	444	444	235	235	235
	L 36 W	126	216	250	126	129	129	250	250	250	129	129	129
	L 58 W	126	129	129	81	81	81	129	129	129	81	81	81
50	L 18 W	180	247	555	180	247	294	555	555	555	294	294	294
	L 36 W	180	247	312	161	161	161	312	312	312	161	161	161
	L 58 W	161	161	161	102	102	102	161	161	161	102	102	102
63	L 18 W	170	340	567	170	340	370	700	700	700	370	370	370
	L 36 W	170	340	393	170	203	203	393	393	393	203	203	203
	L 58 W	170	203	203	128	128	128	203	203	203	128	128	128

¹⁾ All ECGs are turned on simultaneously.

²⁾ The ECGs are turned on in groups one after the other.

Circuit impedance:

The specified lamp loads apply, taking into account a line impedance of 800 mΩ.

At 400 mΩ, the permissible values are reduced by 10 %.

Reduction factors for miniature circuit breakers for the simultaneous switching on of incandescent lamp loads, referred to the rated current of the miniature circuit breaker and the total operational current of the lamps

	Reduction factor	
	Switching with miniature circuit breaker	Switching with separate switch
5SL, 5SY, 5SP4		
Characteristic A	0.3	0.35
Characteristic B	0.5	0.6
Characteristic C	1	1
Characteristic D	1	1

Miniature Circuit Breakers

Configuration and dimensioning

Current carrying capacity of miniature circuit breakers with corrected and uncorrected HQ, HQI and NAV lamps (number)

		Lamp power [W]							
		35	70	150	250	400	1000	2000	3500
lamp current	[A]	0.5	1	1.8	3	3.5	9.5	10.3	18
Corrected lamp current	[A]	0.3	0.5	1	1.5	2	6	5.5	9.8
Inrush peak	[A]	10	18	36	60	70	120	125	220

		Lamp power [W]							
I_n [A]		35	70	150	250	400	1000	2000	3500
5SY4...-6, 5SY6...-6 (without 5SY60), 5SY7...-6									
Characteristic B	6	2	1	0	0	0	0	0	0
	10	5	3	1	1	0	0	0	0
	13	7	4	2	1	1	0	0	0
	16	8	5	2	1	1	0	0	0
	20	11	6	3	1	1	1	1	0
	25	13	7	3	2	2	1	1	0
	32	16	8	4	2	2	1	1	0
	40	20	11	5	3	3	1	1	1
	50	28	15	7	4	4	2	2	1
	63	26	14	7	4	3	2	2	1
5SY4...-7, 5SY6...-7 (without 5SY60), 5SY7...-7									
Characteristic C	6	6	3	1	1	0	0	0	0
	8	8	4	2	1	1	0	0	0
	10	10	6	3	1	1	0	0	0
	13	13	7	3	2	1	1	1	0
	16	16	9	4	2	2	1	1	0
	20	18	10	5	3	2	1	1	0
	25	25	14	7	4	3	2	1	1
	32	22	12	6	3	3	2	1	1
	40	33	18	9	5	4	2	2	1
	50	38	21	10	6	5	3	3	1
	63	53	29	14	9	7	4	4	2
5SY4...-8, 5SY7...-8									
Characteristic D	6	8	4	2	1	1	0	0	0
	8	11	5	3	2	1	0	0	0
	10	14	7	4	2	2	0	0	0
	13	18	9	5	3	2	1	1	0
	16	22	11	6	3	3	1	1	0
	20	28	14	7	4	4	1	1	0
	25	35	17	9	5	5	2	1	1
	32	44	22	12	7	6	2	2	1
	40	56	28	15	9	8	3	2	1
	50	70	35	19	11	10	4	3	2
	63	88	44	24	14	12	4	4	2
5SP4...-7									
Characteristic C	80	76	42	21	12	11	6	6/5	3
	100	98	54	27	16	14	8/7	8/6	4
	125	116	64	32	19	16	9	9/8	5
5SP4...-8									
Characteristic D	80	143/112	80/56	40/31	24/18	20/16	9/6	10/5	5/3
	100	186/140	103/70	51/39	31/23	26/20	11/7	12/6	7/4

Different data apply for corrected/uncorrected lamps.

Direct current, universal current

The 5SL, 5SY, 5SP4 and 5SJ4...HG.. miniature circuit breakers can also be used in DC systems. The max. voltage per pole must not exceed 72 V DC.

A multiple of this can be achieved through series connection of two or more poles depending on the circuit, e.g. max. 144 V DC through series connection of two poles. However, care must be taken not to exceed the max. voltage of 72 V DC per pole depending on the overall circuit.

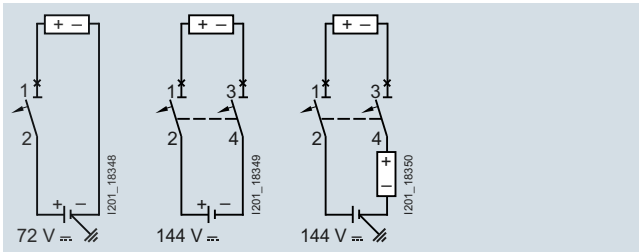

For higher DC voltages, we recommend UC (UC = Universal Current) miniature circuit breakers from the 5SY5 series, which can be used for both AC and DC applications.

The maximum voltage for 5SY5 UC devices is 250VDC per pole. The series connection of individual poles enables 4-pole devices (for example) to be used for up to a maximum of 1000 V DC.

The arcing chamber area of the 5SY5 miniature circuit breakers is equipped with additional permanent magnets to support the positive quenching of the electric arc. This is why the polarity of the breaker is marked. It is essential to pay attention to the conduction direction when connecting the conductor. Suitable precautions should be taken during plant configuration to ensure there can be no polarity reversal in DC operation (e.g. photovoltaic plants).

Miniature Circuit Breakers

Configuration and dimensioning

Line system	Single-ended grounding	Neutral point symmetrically grounded	Insulated / Not grounded
Circuit diagram			
Fault types	a In the event of a fault between the positive and negative pole, the maximum short-circuit current from both poles will be fed with full voltage and be protected by the pole of the miniature circuit breaker which is switched in the positive pole.	a In the event of a fault between the positive and negative pole, the maximum short-circuit current from both poles will be fed with full voltage.	a In the event of a fault between the positive and negative pole, the maximum short-circuit current from both poles will be fed with full voltage and be protected by the pole of the miniature circuit breaker which is switched in the positive and negative pole.
b	In the event of a fault between a non-grounded pole and ground, the maximum short-circuit current will be fed with full voltage and be protected by the pole of the miniature circuit breaker which is switched in the positive pole.	In the event of a fault between the positive pole and ground, the maximum short-circuit current will be fed with a voltage of $0.5 \times U$ and be protected only by the poles of the miniature circuit breaker which is switched in the positive pole.	A fault between a pole and ground has no consequences.
c	A fault between a pole and ground has no consequences.	See fault b, but concerns only the negative pole.	A fault between a pole and ground has no consequences.
Circuit	The poles of the miniature circuit breaker which are required for protection must be connected in series to the non-grounded pole. If the positive pole is grounded, the negative pole must be protected. If an isolating function is required, the grounded pole must also be protected.	The miniature circuit breaker must be equipped at the positive and negative pole for disconnecting the short-circuit current at $0.5 \times U$.	The positive and negative pole must be protected by the corresponding number of poles of the miniature circuit breaker.
U_{max} ≤ 250 V	1-pole disconnection 	2-pole/all-pole disconnection 	2-pole/all-pole disconnection
≤ 500 V			
≤ 1000 V			

Load (e.g. inverter)

Power supply (e.g. solar module, battery)

Overview

UL standards are used in North America as well as in several other countries. This is of particular importance to European exporters of electrical switchgear assemblies and equipment for machines who export to the USA, as their products will only be accepted if they meet the relevant UL standards.

A wide range of low-voltage circuit protection devices from Siemens comply with UL standards and are therefore suitable for implementation worldwide in both IEC/EN and UL applications within the framework of their specified use.

Miniature circuit breakers certified to UL 489 permit use as an all-round solution for protection tasks in distribution boards, control cabinets and control systems to UL 508A as "branch protectors". In particular, they are also approved for the protection of electrical circuits in heating, ventilating and cooling systems (HVAC), as well as for DC applications up to 60 V/125 V.

This covers a wide range of protection tasks, in residential and non-residential buildings, as well as in industry. The tripping characteristics B, C and D to EN/IEC 60898-1 have been adapted so that they fall in the permissible tripping range according to UL 489, as well as for applications at 25 °C and 40 °C.

This means that the devices are approved for use according to both standards. The enclosure dimensions of the devices correspond to DIN format. This means that the device series are suitable for universal use worldwide according to IEC or UL standards.

The key difference between the three device series is their application in different power supply systems.

- 5SJ4...-HG40: 240/120 V AC, 1-pole, "same polarity only"
- 5SJ4...-HG41: 240 V AC, 1-, 2- and 3-pole
- 5SJ4...-HG42: 480Y/277 V AC, 1-, 2- and 3-pole

The terminals are suitable for "field wiring". This means that the devices can be installed not only in factory-built distribution boards and control cabinets, but also on-site in a customer system.

Using this mounting concept, all 5ST3...-HG additional components can be combined with miniature circuit breakers of the 5SJ4...-HG range. The auxiliary switch (AS) signals the contact position. In the event of a fault, the fault signal contact (FC) signals the automatic tripping of the MCB as well as the contact position. Shunt trips (ST) are used for the remote tripping of miniature circuit breakers. Captive metal brackets on the additional components ensure fast mounting on the devices.

Single, two and three-phase busbars in 3 lengths with 6, 12 or 18 pins are available as accessories for all device series for "field wiring". The infeed is via connection terminals, which are available in two versions, for direct infeed at either the busbar or the miniature circuit breakers. Pins that are not required can be covered with touch protection covers.

Miniature Circuit Breakers

5SJ4...-HG miniature circuit breakers acc. to UL 489 and IEC, and accessories

Technical specifications

		5SJ4...-HG40	5SJ4...-HG41	5SJ4...-HG42
Standards		EN 60947-2; UL 489 (UL File E243414); UL 489A (UL File E332105); CSA C22.2 No. 5-02		
Approvals		www.siemens.com/lowvoltage/certificates		
Tripping characteristic		B, C, D	C, D	
Rated voltage				
• Acc. to EN 60947-2	V AC	230/400	230/400	230/400
• Acc. to UL 489 and CSA C22.2 No.5-02	V AC	240/120	240	480/277
	DC V/1P	60	60	60
	DC V/2P	--	125	125
Operational voltage	Min.	V AC/DC per pole	24	
• Acc. to IEC 60898-1	Max.	V DC/pole	60	
	Max.	V AC	250/440	
• Acc. to UL 489	Max.	V DC/pole	72	
Rated breaking capacity				
• I_{cn} acc. to IEC 60898-1	kA AC	10		
• I_{cu} acc. to IEC 60947-2	kA AC	15		
• Acc. to UL 489/UL 489A and CSA C22.2 No. 5-02	kA AC	14/10 ¹⁾	14/10 ¹⁾	10 ¹⁾
Insulation coordination				
• Rated insulation voltage	V AC	250	250/440	
• Pollution degree for overvoltage category		3/III		
Rated frequency	Hz	50/60		
Touch protection acc. to EN 50274		Yes		
Handle end position, sealable		Yes		
Degree of protection acc. to EN 60529		IP40 in the area of the handle		
CFC and silicone-free		Yes		
Mounting		On standard mounting rail		
Terminals	± screw (Pozidriv)	2		
• Combined terminals at both ends		Yes		
• Terminal tightening torque for Cu, 60/75 °C	Nm	3,5		
	lb/in	31		
Conductor cross-sections				
• Solid and stranded, acc. to UL489 and CSA C22.2 No.5-02	AWG	14 ... 4		
• Solid and stranded, according to IEC 60898-1	mm ²	1.5 ... 25		
• Finely stranded, with end sleeve	mm ²	1.5 ... 25		
Mains connection		Any		
Mounting position		Any		
Service life, on average, with rated load		20000 actuations		
EMC environment		Suitable for environment "B" (immunity to interference not applicable)		
• Acc. to EN 60947-2				
Ambient temperature	°C	-25 ... +55, max. 95 % humidity		
Storage temperature	°C	-40 ... +75		
Resistance to climate acc. to IEC 60068-2-30		6 cycles		
Resistance to vibrations acc. to IEC 60068-2-6	m/s ²	50 at 25 ... 150 Hz and 60 at 35 Hz (4 sec)		

¹⁾ For detailed information on rated switching capacity, see page 117.

5SJ4...-HG miniature circuit breakers acc. to UL 489 and IEC, and accessories

Additional components	Auxiliary switches (AS)		Fault signal contacts (FC)		Shunt trips (ST)	
	5ST3010-0HG 5ST3011-0HG 5ST3012-0HG		5ST3020-0HG 5ST3021-0HG 5ST3022-0HG		5ST3030-0HG	5ST3031-0HG
Standards	UL 489, UL-File E321559; CSA 22.2 No. 5-02 IEC/EN 62019, IEC/EN 60947-5-1				IEC/EN 60947-1	
Operational voltage/operational current (load)						
• Acc. to IEC	V AC A AC V DC A DC	400 2 220 1	230 6 (NC: 13 AC, NO: AC14) 110 1	60 24 3 6 (DC13)		110 ... 415 -- 24 ... 60 --
• Acc. to UL	V AC A AC V DC A DC	480 1.5 125 1	277 3 60 3	240 4 6	120 6	110 ... 480 -- 24 ... 60 --
Rated frequency	Hz	50/60				
Short-circuit protection	Miniature circuit breaker or 6 A fuse					
Minimum contact load	50 mA, 24 V					
Tripping operations	--				Max. 2000	
Service life, on average, with rated load	12000 actuations					
Primary operating range	x U_n	--				0.7 ... 1.1
Conductor cross-sections	AWG mm ²	22 ... 14 0.5 ... 2.5		22 ... 14 0.5 ... 2.5		
Terminals	± screw (Pozidriv)	1		1		1
• Terminal tightening torque	Nm lb/in	0.5 4.5				0.8 6.8

Version	Busbars		Busbars can be cut	Terminals		
Type	5ST3663-.HG ¹⁾ 5ST3664-.HG ¹⁾ 5ST3665-.HG ¹⁾		5ST3701-3HG 5ST3703-3HG 5ST3705-3HG 5ST3707-3HG 5ST3710-3HG 5ST3712-3HG 5ST3714-3HG	5ST3666-0HG ¹⁾	5ST3666-2HG ¹⁾	5ST3770-3HG
Standards	UL 489; UL File No. E321559		UL 489; UL File No. E315616	UL 489; UL File No. E321559		UL 489; UL File No. E315616
Operational voltage	V AC V AC	1000/1-pole 1000/1-pole		600/2- to 3-pole 600/2- to 3-pole (60 Hz)		
Rated conditional short-circuit current	kA	10 kA at 600 V	10 kA at 600 V with J 175 A fuse	10 kA at 600 V		10 kA at 600 V with J 175 A fuse
• Dielectric strength	kV/mm	35				
• Surge strength	kV	> 9.5	> 10	> 9.5		> 10
Rated current	A	115 At 40 °C ambient temperature	80 (infeed end) 160 (infeed middle) At 35 °C ambient temperature	115 (Cu 75 °C) 95 (Cu 60 °C) At 40 °C ambient temperature	115 (Cu 75 °C) 110 (Cu 60 °C) At 40 °C ambient temperature	115 (Cu 75 °C) 95 (Cu 60 °C) At 35 °C ambient temperature
Insulation coordination		2 III				
• Pollution degree						
• Overvoltage category						
Busbar cross-section (Cu)	mm ²	16	18	16		18
Infeed		Any				
Conductor cross-sections						
• AWG cables	AWG	--		14 ... 2	14 ... 1	14 ... 2
• Solid and stranded	mm ²	--		2.5 ... 35	2.5 ... 50	2.5 ... 35
Terminals		Hexagon socket 6 mm ± screw (Pozidriv) 2				
• Terminal tightening torque	Nm lb/in	--		5.5 50	4 35	5.5 50
Temperature resistance	°C	125 – UL 94-V0/0.4 mm				
Interrupting rating		10 kA at 600 V AC/DC				

¹⁾ Note:

The busbars and terminals are suitable for applications up to 80 A if installed in distribution boards with min. dimensions of 18 x 18 x 6.25 inches, or up to 115 A if installed in distribution boards with min. dimensions of 30 x 30 x 10 inches.

Miniature Circuit Breakers

5SJ4...-HG miniature circuit breakers acc. to UL 489 and IEC, and accessories

Characteristic curves

Tripping characteristics acc. to IEC/EN 60898-1 and UL 489/CSA 22.2 No. 5-02

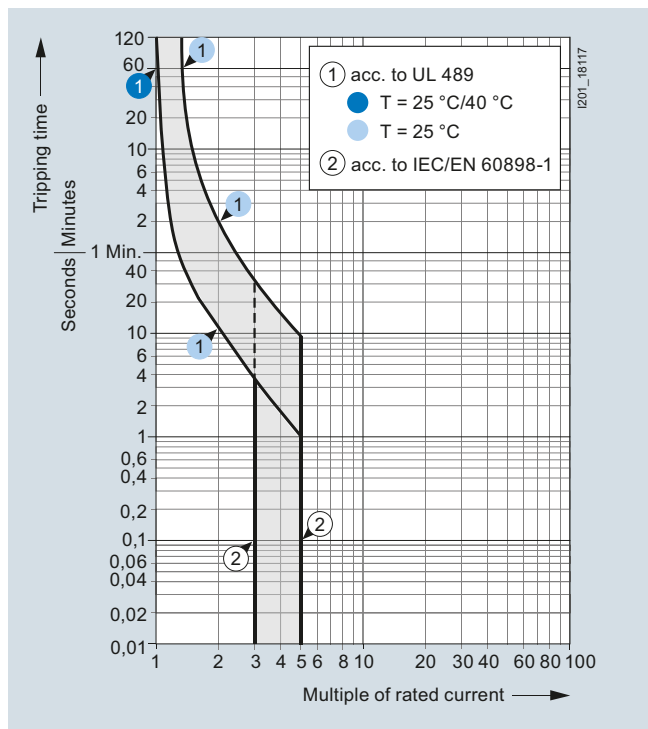

Tripping characteristic B

MCBs with this tripping characteristic are designed for universal use in socket outlet and lighting circuits. Proof of personal safety acc. to DIN VDE 0100-410 is not required.

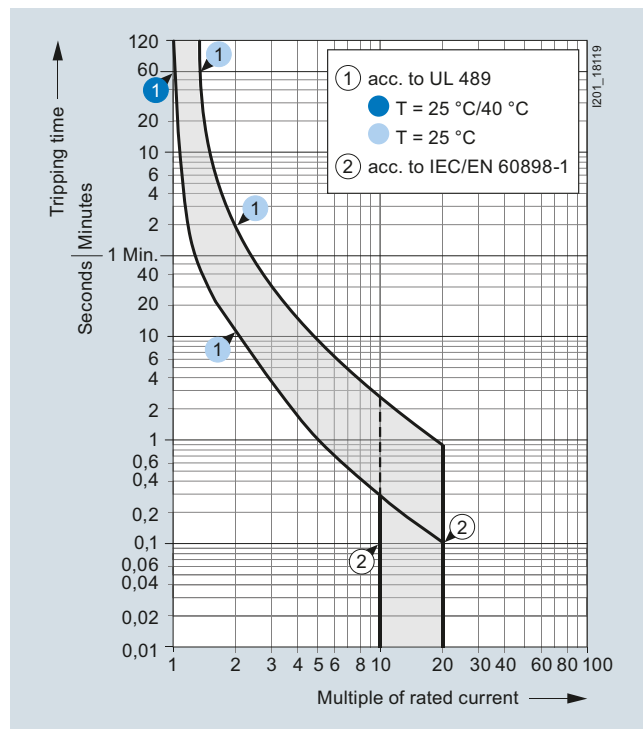

Tripping characteristic D

For electrical circuits with strong pulse-generating equipment, such as transformers or solenoid valves.

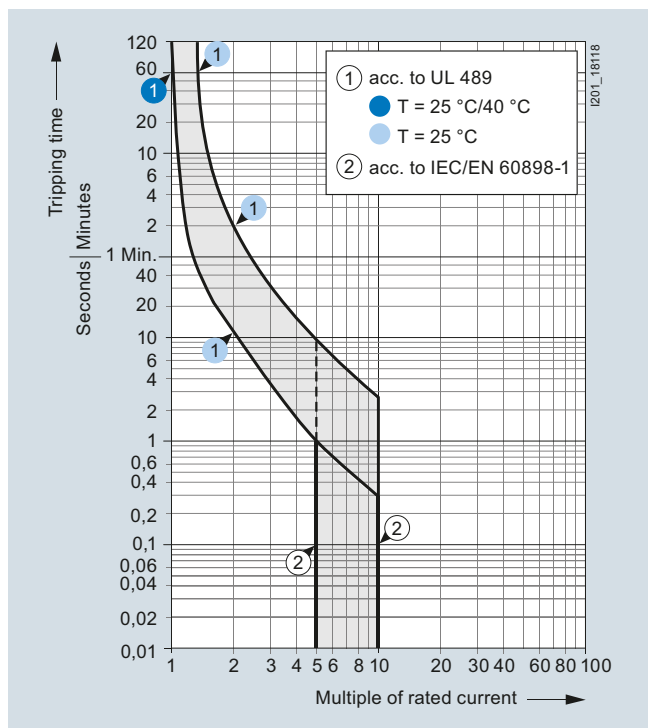

Tripping characteristic C

Primarily used in lamp and motor circuits with higher starting currents.

Correction factors for rated current at different ambient temperatures

Dependence of the permissible continuous load on ambient temperature.

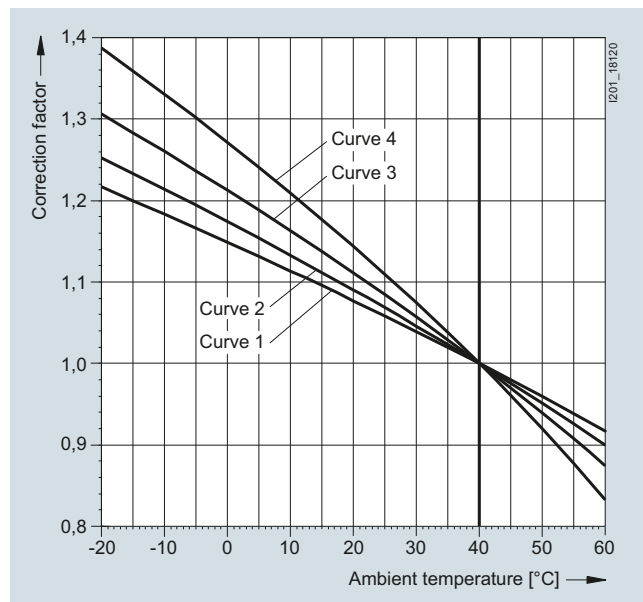

5SJ4...-HG miniature circuit breakers acc. to UL 489 and IEC, and accessories

Correction factor for 5SJ4...-HG miniature circuit breakers
(for curves, see diagram on previous page)

Rated current (A)	0.3	0.5	1	1.6	2	3	4	5	6	8	10	13	15	16	20	25	30	32	35	40	45	50	60	63
Number of poles	Valid curve for correction factor for 5SJ4...-HG miniature circuitbreakers																							
1	4	4	4	4	3	3	2	2	2	2	3	3	3	3	3	3	3	3	3	3	2	2	3	2
2	4	4	3	3	3	3	2	2	2	2	3	3	3	2	2	2	2	2	2	2	1	2	2	1
3	4	4	3	3	3	3	2	2	2	2	3	3	3	2	2	2	2	2	2	2	1	1	1	1

Current carrying capacity at ambient temperatures other than 40 °C

In the event of ambient temperatures other than 40 °C, refer to the following table for the current carrying capacity of the 5SJ4...-HG miniature circuit breakers.

Rated current I_n (A) at 40 °C		Permissible rated current I_n (A), depending on the ambient temperature						
Rated current I_n (A)	Number of poles	15 °C	20 °C	25 °C	30 °C	40 °C	50 °C	55 °C
0.3	1/2/3	0.35	0.34	0.33	0.32	0.30	0.28	0.26
0.5	1/2/3	0.59	0.57	0.55	0.54	0.50	0.46	0.44
1	1	1.2	1.1	1.1	1.1	1.0	0.9	0.9
	2/3	1.1	1.1	1.1	1.1	1.0	0.9	0.9
1.6	1	1.9	1.8	1.8	1.7	1.6	1.5	1.4
	2/3	1.8	1.8	1.7	1.7	1.6	1.5	1.5
2	1/2/3	2.3	2.2	2.2	2.1	2.0	1.9	1.8
3	1/2/3	3.4	3.3	3.3	3.2	3.0	2.8	2.7
4	1/2/3	4.5	4.4	4.3	4.2	4.0	3.8	3.7
5	1/2/3	5.6	5.5	5.3	5.2	5.0	4.8	4.6
6	1/2/3	6.7	6.5	6.4	6.3	6.0	5.7	5.6
8	1/2/3	8.9	8.7	8.6	8.4	8.0	7.6	7.4
10	1/2/3	11.4	11.1	10.8	10.6	10.0	9.4	9.1
13	1/2/3	14.8	14.4	14.1	13.7	13.0	12.2	11.8
15	1/2/3	17.1	16.7	16.3	15.9	15.0	14.1	13.6
16	1	18.2	17.8	17.4	16.9	16.0	15.0	14.5
	2/3	17.8	17.5	17.1	16.7	16.0	15.2	14.8
20	1	22.8	22.2	21.7	21.1	20.0	18.8	18.1
	2/3	22.3	21.8	21.4	20.9	20.0	19.0	18.5
25	1	28.4	27.8	27.1	26.4	25.0	23.5	22.7
	2/3	27.8	27.3	26.7	26.2	25.0	23.8	23.1
30	1	34.1	33.3	32.5	31.7	30.0	28.2	27.2
	2/3	33.4	32.7	32.1	31.4	30.0	28.5	27.8
32	1	36.4	35.6	34.7	33.8	32.0	30.1	29.0
	2/3	35.6	34.9	34.2	33.5	32.0	30.4	29.6
35	1	39.8	38.9	38.0	37.0	35.0	32.9	31.8
	2/3	38.9	38.2	37.4	36.6	35.0	33.3	32.4
40	1	45.5	44.5	43.4	42.3	40.0	37.6	36.3
	2/3	44.5	43.6	42.8	41.9	40.0	38.0	37.0
45	1	50.1	49.1	48.1	47.1	45.0	42.8	41.7
	2/3	49.3	48.5	47.6	46.8	45.0	43.2	42.2
50	1/2	55.6	54.6	53.5	52.3	50.0	47.6	46.3
	3	54.8	53.9	52.9	52.0	50.0	48.0	46.9
60	1	68.3	66.7	65.1	63.4	60.0	56.4	54.4
	2	66.8	65.5	64.1	62.8	60.0	57.1	55.5
	3	65.7	64.6	63.5	62.4	60.0	57.5	56.3
63	1	70.1	68.7	67.3	65.9	63.0	59.9	58.3
	2/3	69.0	67.9	66.7	65.5	63.0	60.4	59.1

Miniature Circuit Breakers

5SJ4...-HG miniature circuit breakers acc. to UL 489 and IEC, and accessories

Let-through I^2t values 5SJ4...-HG

Characteristic B

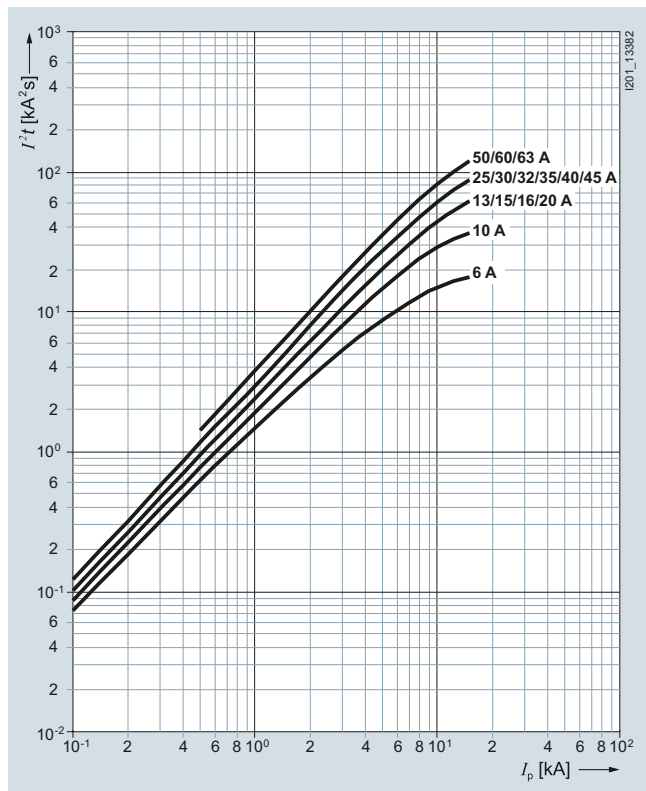

Characteristic D

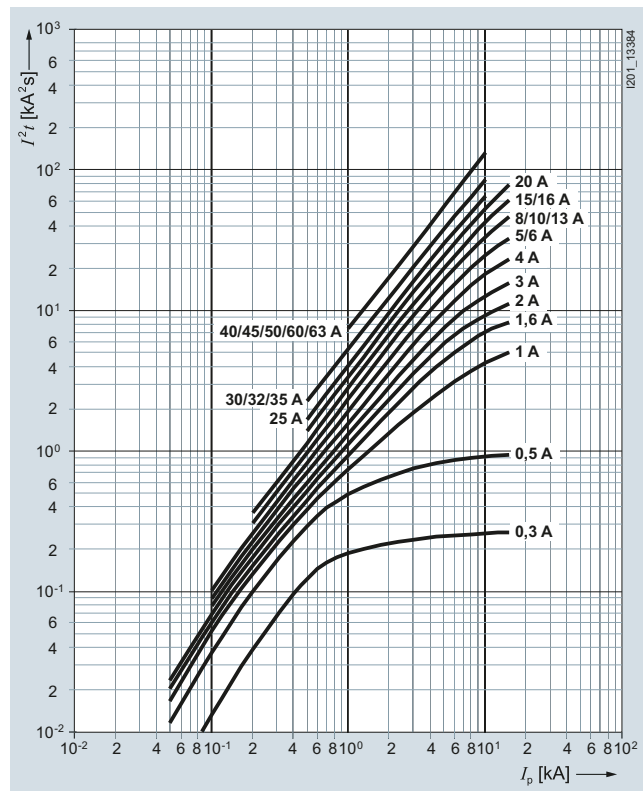

Characteristic C

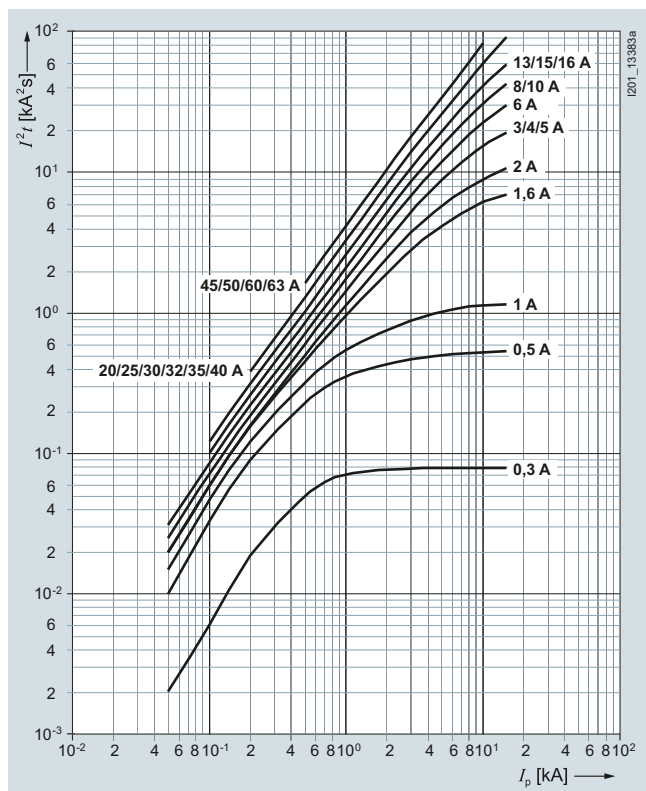

5SJ4...-HG miniature circuit breakers acc. to UL 489 and IEC, and accessories

Dimensional drawings

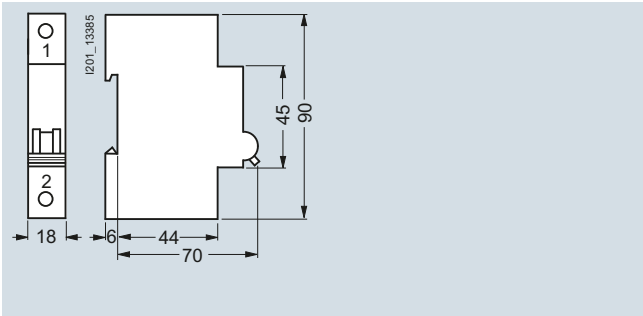

5SJ4...-HG40

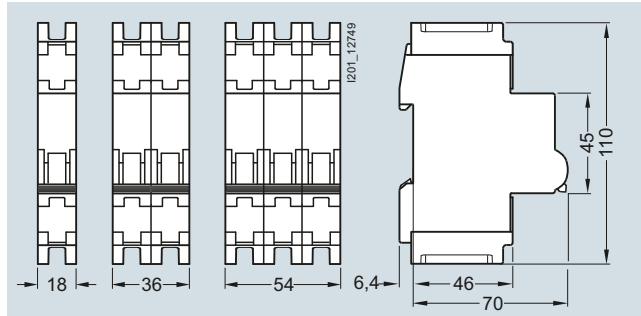

5SJ4...-HG41

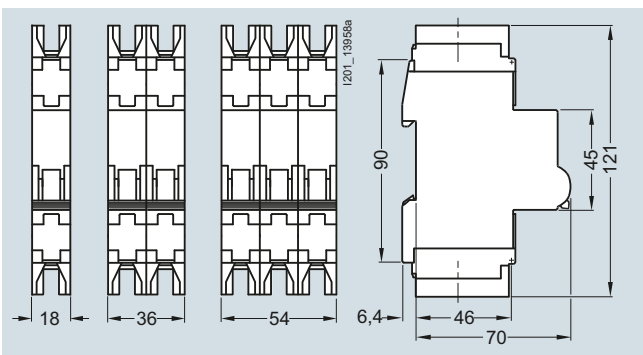

5SJ4...-HG42

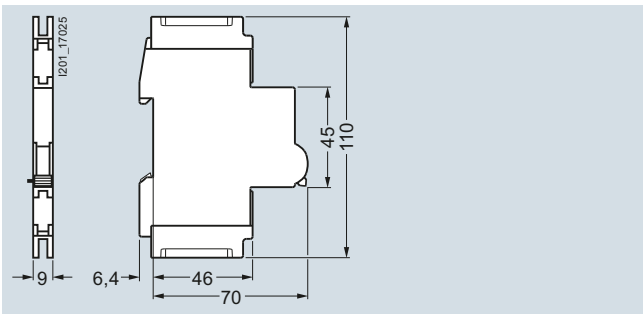

5ST3010-0HG 5ST3011-0HG 5ST3012-0HG
5ST3020-0HG 5ST3021-0HG 5ST3022-0HG

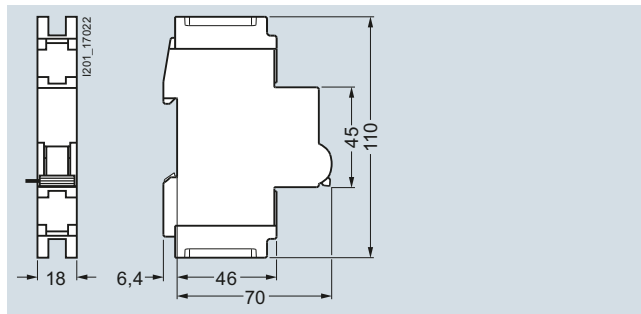

5ST3030-0HG
5ST3031-0HG

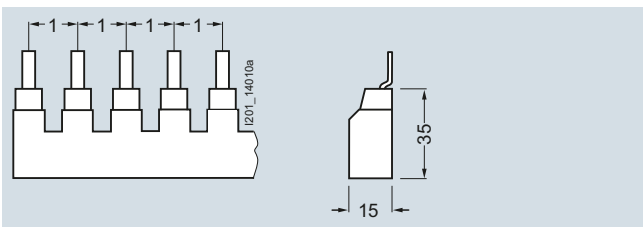

5ST3663-0HG 5ST3664-0HG 5ST3665-0HG
5ST3663-1HG 5ST3664-1HG 5ST3665-1HG
5ST3663-2HG 5ST3664-2HG 5ST3665-2HG

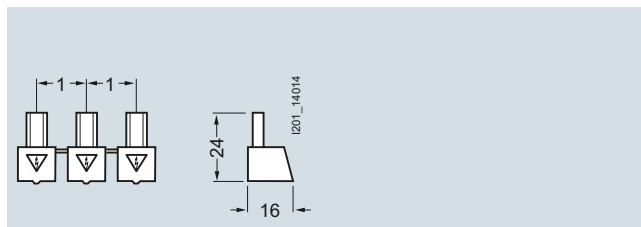

5ST3666-1HG

Note:
Pin spacing in MW
Dimensions of side view in mm, approx.

Note:
Pin spacing in MW
Dimensions of side view in mm, approx.

Miniature Circuit Breakers

5SJ4...-HG miniature circuit breakers acc. to UL 489 and IEC, and accessories

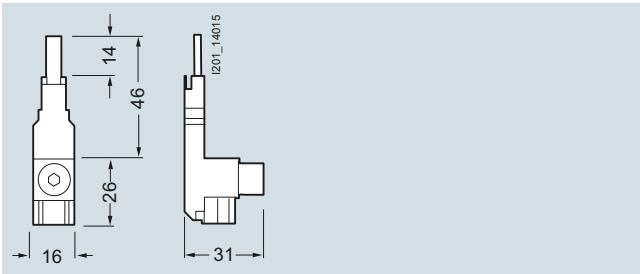

5ST3666-0HG

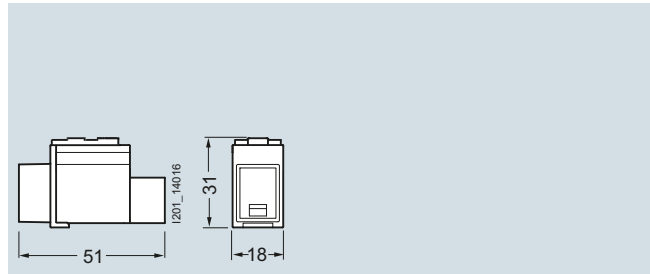

5ST3666-2HG

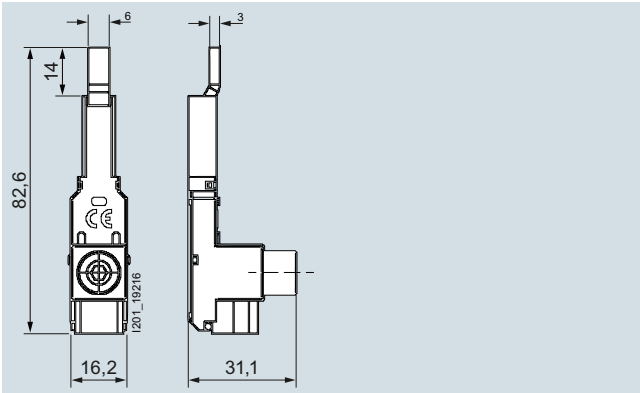

5ST3770-3HG

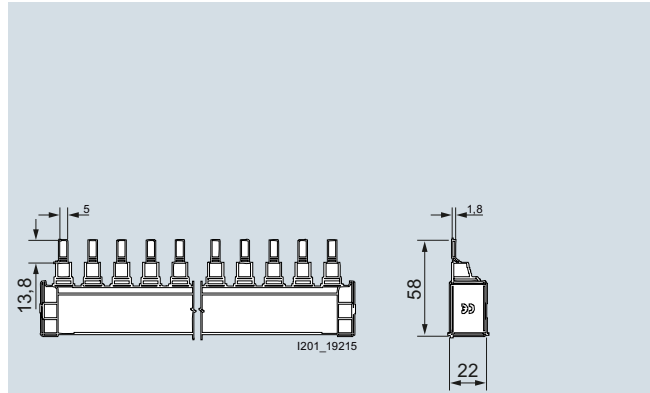

5ST37...-3HG

Circuit diagrams

Graphical symbols

Miniature circuit breakers



5SJ4...-HG
1P

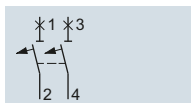

2P

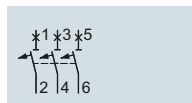

3P

Additional components

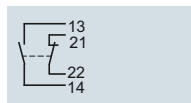

Auxiliary switches (AS)
5ST3010-0HG

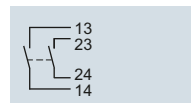

5ST3011-0HG

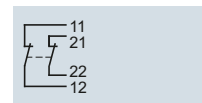

5ST3012-0HG

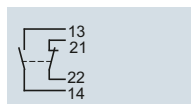

Fault signal contacts (FC)
5ST3020-0HG

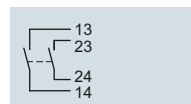

5ST3021-0HG

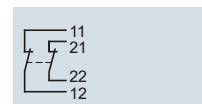

5ST3022-0HG

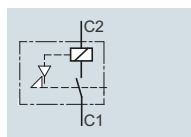

Shunt trips (ST)
5ST3030-0HG
5ST3031-0HG

5SJ4...-HG miniature circuit breakers acc. to UL 489 and IEC, and accessories

More information

Rated switching capacity acc. to UL 489

Designation	Characteristic	Current	Rated switching capacity (operational voltage 240 V AC)	Rated switching capacity (operational voltage 480Y/277 V AC)
		A	kA AC	kA AC
5SJ4...-HG40	B	6 ... 63	14	--
	C	0.3 ... 40	14	--
	C	45 ... 63	10	--
	D	0.3 ... 20	14	--
5SJ4...-HG41	D	25 ... 63	10	--
	C	0.3 ... 40	14	--
	C	45 ... 63	10	--
	D	0.3 ... 20	14	--
5SJ4...-HG42	D	25 ... 63	10	--
	C	0.3 ... 40	14	10
	D	0.3 ... 20	14	10
	D	25 ... 32	10	10

Miniature Circuit Breakers

5SJ4...-HG miniature circuit breakers acc. to UL 489 and IEC, and accessories

Internal resistance and power loss per pole at I_n

Rated current I_n A	Characteristic B		Characteristic C		Characteristic D	
	R_i mΩ	P_v W	R_i mΩ	P_v W	R_i mΩ	P_v W
0.3	--	--	12900	1.2	12600	1.1
0.5	--	--	4900	1.2	4600	1.2
1	--	--	1650	1.7	1480	1.5
1.6	--	--	620	1.6	570	1.5
2	--	--	440	1.8	435	1.8
3	--	--	197	1.8	190	1.7
4	--	--	115	1.8	100	1.6
5	--	--	115	2.9	100	2.5
6	85	3.1	74	2.7	73	2.6
8	--	--	40	2.6	39	2.5
10	16.5	1.7	13.5	1.4	11.9	1.2
13	11.7	2.0	10.2	1.7	10.2	1.7
15	8.5	1.9	7.8	1.8	7.7	1.7
16	8.5	2.2	7.8	2.0	7.7	2.0
20	6.7	2.7	5.5	2.2	5.5	2.2
25	4.3	2.7	4.2	2.6	4.2	2.6
30	3.4	3.1	3.5	3.2	3.0	2.7
32	3.4	3.5	3.5	3.6	3.0	3.1
35	2.8	3.4	2.8	3.4	2.7	3.3
40	2.8	4.5	2.8	4.5	2.5	4.0
45	2.8	5.7	2.7	5.5	2.5	5.1
50	2.1	5.3	2.1	5.0	2.0	5.0
60	1.7	6.1	1.7	6.1	1.7	6.1
63	1.7	6.7	1.7	6.7	1.7	6.7

Mounting concept for mounting 5ST30...-0HG accessories on 5SJ4...-HG miniature circuitbreakers

The diagram shows which additional components can be mounted on the right.

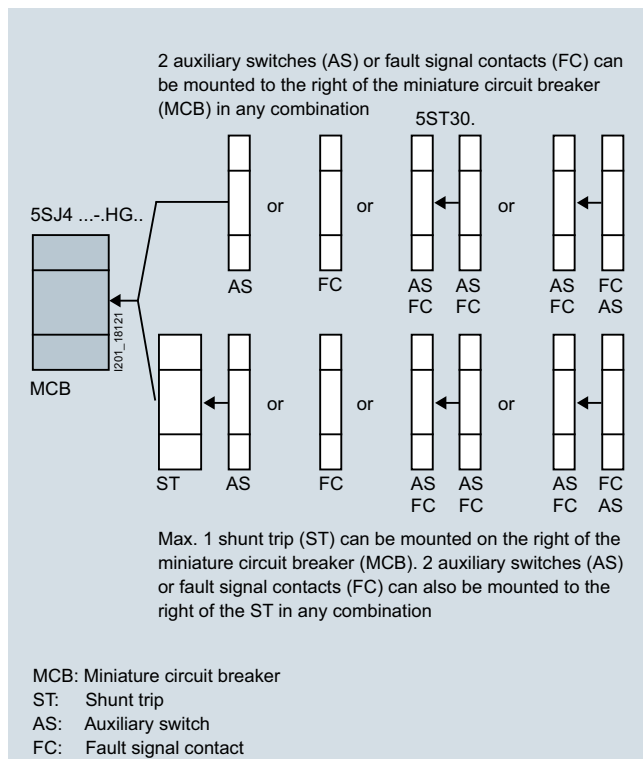

Rated tripping current I_t of the instantaneous tripping operation

Characteristic	Rated current I_n	I_t [A]
B	6 ... 63 A	$4 I_n$
C	5 A	$6.5 I_n$
C	0.5 ... 4 A, 6 ... 13 A, 20 ... 63 A	$7.5 I_n$
C	16 A	$8 I_n$
C	0.3 A, 15 A	$8.5 I_n$
D	0.3 A	$8.5 I_n$
D	8 A	$10 I_n$
D	1 A, 35 A	$11 I_n$
D	32 A	$11.5 I_n$
D	30 A, 63 A	$12 I_n$
D	50 A, 60 A	$12.5 I_n$
D	0.5 A	$13.5 I_n$
D	1.6 A, 2 A, 4 A, 6 A, 10 ... 25 A, 40 A, 45 A	$14 I_n$
D	3 A	$14.5 I_n$
D	5 A	$16 I_n$

Overview

The selective main miniature circuit breaker is used as a circuit breaker on meter panels.

Characteristic E is adapted to the special application requirements for cascade circuits between melting fuses and miniature circuit breakers in distributor circuits.

Used in conjunction with downstream miniature circuit breakers, SHU 5SP3 main miniature circuit breakers ensure effective protection and optimum availability of the plant.

Benefits

- Quick and easy installation on standard mounting rail
- Reliable and high selectivity
- Optimum availability of the consumer load
- The SHU 5SP3 main miniature circuit breaker operates on a voltage-independent basis
- High and safe selectivity between sub-distribution and meter panel ensures the continued supply of the unaffected circuits in the event of a fault, thus improving system availability
- In the event of a fault, the SHU 5SP3 main miniature circuit breaker prevents an existing short-circuit from being reconnected until the cause of the fault has been eliminated
- The SHU 5SP3 selective main miniature circuit breaker ensures fast and safe disconnection and reconnection of loads
- It complies with all the requirements of TAB 2007 and can therefore be used in metering systems

Technical specifications

		5SP37..., 5SP37...-1	5SP37...-2, 5SP37...-2KK0.	5SP38...-2
Standards		DIN VDE 0645	DIN VDE 0641-21	
Rated voltage U_n				
• 1-pole	V AC	230/400		--
• 3 x 1-pole	V AC	400	--	400
Operational voltage				
	Min.	V AC	110	
	Max.	V AC	440	
Rated frequency		Hz	50 ... 60	
Rated current I_n		A	16 ... 100	16 ... 63
Rated insulation voltage U_i		V AC	690	
Rated making and breaking capacity I_{cn}		A	25000	
Insulation coordination				
• Overvoltage category			IV	
• Pollution degree			3	
Impulse withstand voltage U_{imp}		kV	6	
Impact resistance			30 g, at least 3 impacts, impact duration 11 ms	
Resistance to vibrations			2 g, 20 frequency cycles 5 ... 150 ... 15 Hz	
Switching position indication			OFF = green, ON = red	
Main switch characteristics		Acc. to EN 60204-1	Yes	
Handle end position, sealable			Yes	
Cutoff		ON/OFF	--	Locking slide with lock, additional wire seal, cable ties and Antilux
Device depth		mm	92	
Degree of protection			IP20, with connected conductors	
Mains connection			Any	
Mounting position			Any	
Mounting			On standard mounting rail or interface adapter	Direct tool-free mounting on the busbar system
Service life, on average, with rated load		Actuations	20000	
Wire connections			Saddle terminals at both ends	
• Top				Screwless spring terminal for flexible cables, in particular for meter connecting cables acc. to DIN 43870-3
• Bottom				Box terminal, also for infeed to the busbar system, up to 100 A infeed current
Conductor cross-sections				
• Top and bottom, solid and stranded	mm ²	2.5 ... 70	--	
• Top and bottom, finely stranded	mm ²	2.5 ... 50	--	
• Top, finely stranded	mm ²	--	2.5 ... 16	
• Bottom, solid, stranded and finely stranded, with end sleeve	mm ²	--	2.5 ... 50	
Storage temperature		°C	-40 ... +70	
Ambient temperature		°C	-25 ... +55	

Miniature Circuit Breakers

SHU 5SP3 main miniature circuit breakers

			5SP37..-3	5SP38..-3	5SP32..-3	5SP33..-3	5SP34..-3
Standards			DIN VDE 0641-21				
Rated voltage U_n							
• 1-pole	V AC		230	--	--	--	--
• 3 x 1-pole	V AC		--	230	--	--	--
• 2-pole	V AC		--	--	400	--	--
• 3-pole	V AC		--	--	--	400	--
• 4-pole	V AC		--	--	--	--	400
Operational voltage		Min.	V AC	110			
		Max.	V AC	440			
Rated frequency			Hz	50 ... 60			
Rated current I_n			A	16 ... 63			
Rated insulation voltage U_i			V AC	690			
Rated making and breaking capacity I_{cn}			A	25000			
Insulation coordination							
• Overvoltage category			IV				
• Pollution degree			3				
Impulse withstand voltage U_{imp}			kV	6			
Impact resistance			25 g, at least 3 impacts, impact duration 13 ms				
Resistance to vibrations			2 g, 20 frequency cycles 5 ... 150 ... 15 Hz				
Switching position indication			OFF = green, ON = red				
Isolating function		Acc. to DIN VDE 0100-0537		Yes			
Handle end position, sealable		Yes					
Cutoff			ON/OFF	Integrated locking slide, lockable by means of a lock, wire seal and cable ties			
Device depth			mm	91.1			
Degree of protection			IP40, with mounted distribution cover, cutout dimension 46 mm				
Mains connection			Any				
Mounting position			Any				
Mounting			On standard mounting rail 35 mm acc. to EN 60715				
Wire connections			Box terminals				
Conductor cross-sections							
• Top and bottom, solid, stranded and finely stranded			mm ²	2.5 ... 50			
Storage temperature			°C	-40 ... +70			
Ambient temperature			°C	-25 ... +55			

Configuration

Internal resistances and power losses

- Internal resistances per pole in mΩ cold state
- Power loss per pole in W for rated current

Type	Rated current A	R_i mΩ	P_{max} W
5SP37...-2, 5SP37...-2KK0., 5SP38...-2	16	15.3	4.5
	20	11.3	6.0
	25	8.7	6.5
	35	4.5	6.9
	40	3.8	6.4
	50	3.5	8.0
	63	2.3	9.7
5SP3...-3	16	15.3	4.1
	20	11.3	5.4
	25	8.7	5.9
	35	4.5	6.3
	40	3.4	6.1
	50	2.9	7.6
5SP37... 5SP37...-1	16	15.5	5.2
	20	12.5	6.5
	25	7.4	6.5
	32	5.3	7.2
	35	4.0	7.6
	40	4.0	8.0
	50	2.9	9.5
	63	2.0	9.9
	80	1.5	13.5
	100	1.0	14.4

Selectivity

Short-circuit selectivity between the SHU 5SP3 main miniature circuit breakers and downstream 5SL/5SY miniature circuit breakers



Due to its principle of action, the SHU 5SP3 main miniature circuit breaker is always short-circuit-selective up to the rated switching capacity of the downstream 5SL/5SY miniature circuit breaker, e.g. 6000 A or 10000 A.

Selectivity of the SHU 5SP3 for the upstream fuse 3NA gG

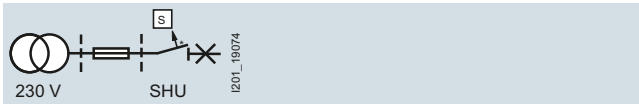

		Selectivity of the SHU 5SP3... main miniature circuit breaker for the upstream fuse 3NA... [kA]												
Fuse		3NA												
Operational class		gG												
Rated voltage U_n [AC V]		230/400												
Downstream main miniature circuit breaker (SHU)		Back-up fuse												
		32	35	40	50	63	80	100	125	160	200	224	250	300
SHU type: 5SP3...	E16	--	0.55	0.75	1.1	1.9	3.3	8	14.6	T	T	T	T	T
Characteristic E	E20	--	0.48	0.6	0.9	1.5	2.5	4.5	7.2	12.8	T	T	T	T
I_{cn} [kA] = 25 kA	E25	--	0.48	0.6	0.9	1.5	2.5	4.5	7.2	12.8	T	T	T	T
	E35	--	--	0.6	0.9	1.5	2.5	4.5	7.2	12.8	T	T	T	T
	E40	--	--	--	0.7	1.3	2	3.6	5.5	8.9	T	T	T	T
	E50	--	--	--	--	1.3	2	3.6	5.5	8.9	T	T	T	T
	E63	--	--	--	--	1.3	2	3.6	5.5	8.9	T	T	T	T

T: Total selectivity up to the rated switching capacity I_{cn} of the downstream SHU 5SP3 main miniature circuit breaker.

Miniature Circuit Breakers

SHU 5SP3 main miniature circuit breakers

Selectivity for the cascade: Fuse 3NA gG – SHU 5SP3 main miniature circuit breaker – 5SL/5SY miniature circuit breaker



In a cascade connection¹⁾ with upstream fuse, SHU 5SP3 main miniature circuit breakers and miniature circuit breakers, the following values result:

		Selectivity for the cascade: Fuse 3NA gG – SHU 5SP3 main miniature circuit breaker – 5SL/5SY miniature circuit breaker [kA]															
Fuse		3NA															
Operational class		gG															
Rated voltage		230/400															
U_n [AC V]																	
SHU		5SP3...															
Characteristic		E															
Downstream miniature circuit breakers	I_n [A]	Back-up fuse															
		63 A				80 A				100 A				125 A			
		SHU															
		E35	E40	E50	E63	E35	E40	E50	E63	E35	E40	E50	E63	E35	E40	E50	E63
Circuit breaker type:	0.3	T	T	T	T	T	T	T	T	T	T	T	T	T	T	T	T
5SY6n...- (n=1...6)	0.5	T	T	T	T	T	T	T	T	T	T	T	T	T	T	T	T
5SL6...-	1	T	T	T	T	T	T	T	T	T	T	T	T	T	T	T	T
Characteristic B/C	1.5	T	T	T	T	T	T	T	T	T	T	T	T	T	T	T	T
I_{cn} [kA] = 6	2	T	T	T	T	T	T	T	T	T	T	T	T	T	T	T	T
	3	T	T	T	T	T	T	T	T	T	T	T	T	T	T	T	T
	4	T	T	T	T	T	T	T	T	T	T	T	T	T	T	T	T
	6	T	T	T	T	T	T	T	T	T	T	T	T	T	T	T	T
	8	T	T	T	5	T	T	T	T	T	T	T	T	T	T	T	T
	10	T	T	T	5	T	T	T	T	T	T	T	T	T	T	T	T
	13	T	T	T	5	T	T	T	T	T	T	T	T	T	T	T	T
	16	5	5	5	4	T	T	T	T	T	T	T	T	T	T	T	T
	20	--	4	4.5	4	--	T	T	T	--	T	T	T	--	T	T	T
	25	--	--	4	3	--	--	T	5.5	--	--	T	T	--	--	T	T
	32	--	--	--	3	--	--	--	5	--	--	--	T	--	--	--	T
	40	--	--	--	--	--	--	--	--	--	--	--	--	--	--	--	--
	50	--	--	--	--	--	--	--	--	--	--	--	--	--	--	--	--
	63	--	--	--	--	--	--	--	--	--	--	--	--	--	--	--	--

T: Total selectivity up to the rated switching capacity I_{cn} of the downstream miniature circuit breaker.

¹⁾ The selectivity limit results from the intersection of the let-through I^2t value of the SHU 5SP3 main miniature circuit breaker and miniature circuit breaker combination with the melting integral of the fuse according to EN 60269 (VDE 0636).

SHU 5SP3 main miniature circuit breakers

		Selectivity for the cascade: Fuse 3NA gG – SHU 5SP3 main miniature circuit breaker – 5SL/5SY miniature circuit breaker [kA]															
Fuse		3NA															
Operational class		gG															
Rated voltage U_n [AC V]		230/400															
SHU		5SP3...															
Characteristic		E															
Downstream miniature circuit breakers	I_n [A]	Back-up fuse															
		63 A				80 A				100 A				125 A			
		SHU															
		E35	E40	E50	E63	E35	E40	E50	E63	E35	E40	E50	E63	E35	E40	E50	E63
Circuit breaker type:	0.3	T	T	T	T	T	T	T	T	T	T	T	T	T	T	T	T
5SY4...-8	0.5	T	T	T	T	T	T	T	T	T	T	T	T	T	T	T	T
5SL4...-8	1	T	T	T	T	T	T	T	T	T	T	T	T	T	T	T	T
Characteristic B/C	1.5	T	T	T	T	T	T	T	T	T	T	T	T	T	T	T	T
I_{cn} [kA] = 10	2	T	T	T	T	T	T	T	T	T	T	T	T	T	T	T	T
	3	T	T	T	T	T	T	T	T	T	T	T	T	T	T	T	T
	4	T	T	T	T	T	T	T	T	T	T	T	T	T	T	T	T
	6	7	7	7	7	T	T	T	7	T	T	T	T	T	T	T	T
	8	7	6	6	5	T	T	T	7	T	T	T	T	T	T	T	T
	10	6	6	6	5	7	7	7	7	T	T	T	T	T	T	T	T
	13	6	6	6	5	7	7	7	6	T	T	T	T	T	T	T	T
	16	5	5	5	4	7	7	7	6	T	T	T	T	T	T	T	T
	20	--	4	4.5	4	--	7	6	6	--	T	T	T	--	T	T	T
	25	--	--	4	3	--	--	6	5.5	--	--	T	T	--	--	T	T
	32	--	--	--	3	--	--	--	5	--	--	--	7	--	--	--	T
	40	--	--	--	--	--	--	--	--	--	--	--	--	--	--	--	--
	50	--	--	--	--	--	--	--	--	--	--	--	--	--	--	--	--
	63	--	--	--	--	--	--	--	--	--	--	--	--	--	--	--	--
Circuit breaker type:	0.3	T	T	T	T	T	T	T	T	T	T	T	T	T	T	T	T
5SY4...-8	0.5	T	T	T	T	T	T	T	T	T	T	T	T	T	T	T	T
5SL4...-8	1	T	T	T	T	T	T	T	T	T	T	T	T	T	T	T	T
Characteristic D	1.5	T	T	T	T	T	T	T	T	T	T	T	T	T	T	T	T
I_{cn} [kA] = 10	2	T	T	T	T	T	T	T	T	T	T	T	T	T	T	T	T
	3	T	T	T	T	T	T	T	T	T	T	T	T	T	T	T	T
	4	7	7	7	7	T	T	T	7	T	T	T	T	T	T	T	T
	6	7	6	6	6	T	T	T	7	T	T	T	T	T	T	T	T
	8	6	6	6	5	7	7	7	7	T	T	T	T	T	T	T	T
	10	6	6	6	5	7	7	7	6	T	T	T	T	T	T	T	T
	13	5.5	6	5.5	4	7	7	7	6	T	T	T	T	T	T	T	T
	16	5	4.5	4.5	4	6	7	7	6	7	T	T	T	T	T	T	T
	20	--	3.5	4	3.5	--	6	6	5.5	--	7	T	T	--	T	T	T
	25	--	--	3.5	3	--	--	5.5	5	--	--	7	7	--	--	T	T
	32	--	--	--	2.5	--	--	--	4.5	--	--	--	6	--	--	--	T
	40	--	--	--	--	--	--	--	--	--	--	--	--	--	--	--	--
	50	--	--	--	--	--	--	--	--	--	--	--	--	--	--	--	--
	63	--	--	--	--	--	--	--	--	--	--	--	--	--	--	--	--

T: Total selectivity up to the rated switching capacity I_{cn} of the downstream miniature circuit breaker.

Miniature Circuit Breakers

SHU 5SP3 main miniature circuit breakers

		Selectivity for the cascade: Fuse 3NA gG – SHU 5SP3 main miniature circuit breaker – 5SL/5SY miniature circuit breaker [kA]															
Fuse		3NA															
Operational class		gG															
Rated voltage U_n [AC V]		230/400															
SHU		5SP3...															
Characteristic		E															
Downstream miniature circuit breakers	I_n [A]	Back-up fuse															
		63 A				80 A				100 A				125 A			
		SHU															
		E35	E40	E50	E63	E35	E40	E50	E63	E35	E40	E50	E63	E35	E40	E50	E63
Circuit breaker type: 5SY7...-. Characteristic B/C I_{cn} [kA] = 15	0.3	T	T	T	T	T	T	T	T	T	T	T	T	T	T	T	T
	0.5	T	T	T	T	T	T	T	T	T	T	T	T	T	T	T	T
	1	T	T	T	T	T	T	T	T	T	T	T	T	T	T	T	T
	1.5	T	T	T	T	T	T	T	T	T	T	T	T	T	T	T	T
	2	T	T	T	T	T	T	T	T	T	T	T	T	T	T	T	T
	3	T	T	T	T	T	T	T	T	T	T	T	T	T	T	T	T
	4	10	10	10	10	T	T	T	T	T	T	T	T	T	T	T	T
	6	7	7	7	7	T	T	T	7	T	T	T	T	T	T	T	T
	8	7	6	6	5	T	T	T	7	T	T	T	T	T	T	T	T
	10	6	6	6	5	7	7	7	7	T	T	T	T	T	T	T	T
	13	6	6	6	5	7	7	7	6	10	10	10	10	T	T	T	T
	16	5	5	5	4	7	7	7	6	10	10	10	10	T	T	T	T
	20	--	4	4.5	4	--	7	6	6	--	10	10	10	--	T	T	T
	25	--	--	4	3	--	--	6	5.5	--	--	10	10	--	--	10	10
	32	--	--	--	3	--	--	--	5	--	--	--	7	--	--	--	10
	40	--	--	--	--	--	--	--	--	--	--	--	--	--	--	--	--
	50	--	--	--	--	--	--	--	--	--	--	--	--	--	--	--	--
63	--	--	--	--	--	--	--	--	--	--	--	--	--	--	--	--	
Circuit breaker type: 5SY7...-8 Characteristic D I_{cn} [kA] = 15	0.3	T	T	T	T	T	T	T	T	T	T	T	T	T	T	T	T
	0.5	T	T	T	T	T	T	T	T	T	T	T	T	T	T	T	T
	1	T	T	T	T	T	T	T	T	T	T	T	T	T	T	T	T
	1.5	T	T	T	T	T	T	T	T	T	T	T	T	T	T	T	T
	2	T	T	T	T	T	T	T	T	T	T	T	T	T	T	T	T
	3	10	10	10	10	T	T	T	T	T	T	T	T	T	T	T	T
	4	7	7	7	7	T	T	T	10	T	T	T	T	T	T	T	T
	6	7	6	6	6	T	T	T	7	T	T	T	T	T	T	T	T
	8	6	6	6	5	10	10	10	7	T	T	T	T	T	T	T	T
	10	6	6	6	5	7	7	7	6	10	10	10	10	T	T	T	T
	13	5	5	5	4.5	7	7	7	6	10	10	10	10	T	T	T	T
	16	4.5	4.5	4.5	4	6	7	6	6	10	10	10	10	10	T	T	T
	20	--	3.5	4	3.5	--	6	6	5.5	--	10	10	10	--	10	10	10
	25	--	--	3.5	3	--	--	5	5	--	--	7	7	--	--	10	10
	32	--	--	--	2.5	--	--	--	4.5	--	--	--	6	--	--	--	10
	40	--	--	--	--	--	--	--	--	--	--	--	--	--	--	--	--
	50	--	--	--	--	--	--	--	--	--	--	--	--	--	--	--	--
63	--	--	--	--	--	--	--	--	--	--	--	--	--	--	--	--	

T: Total selectivity up to the rated switching capacity I_{cn} of the downstream miniature circuit breaker.

Characteristic curves

Characteristic E acc. to DIN VDE 0641-2

5SP3...16-3, 5SP3...20-3, 5SP3...25-3

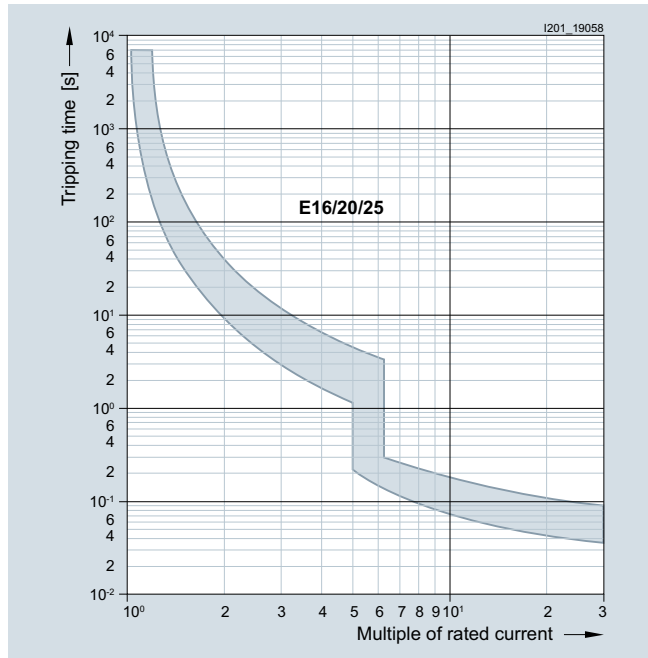

5SP3...35-3, 5SP3...40-3, 5SP3...50-3, 5SP3...63-3

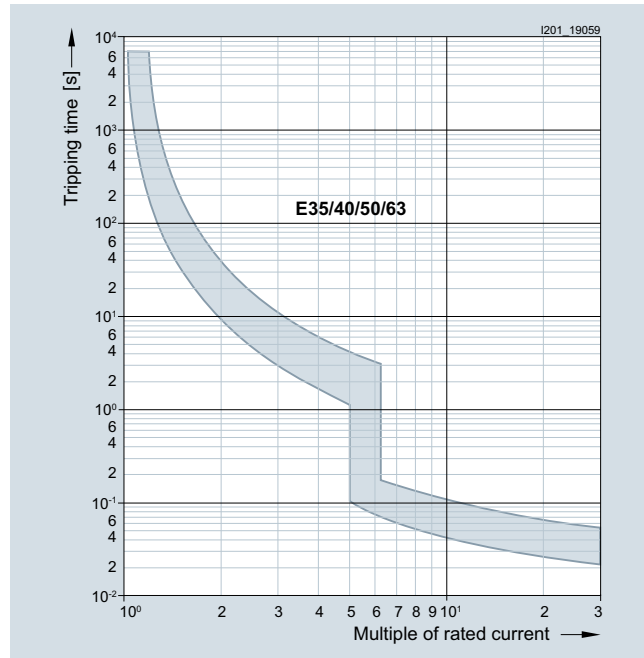

Peak let-through current

5SP37... , 5SP37...-1

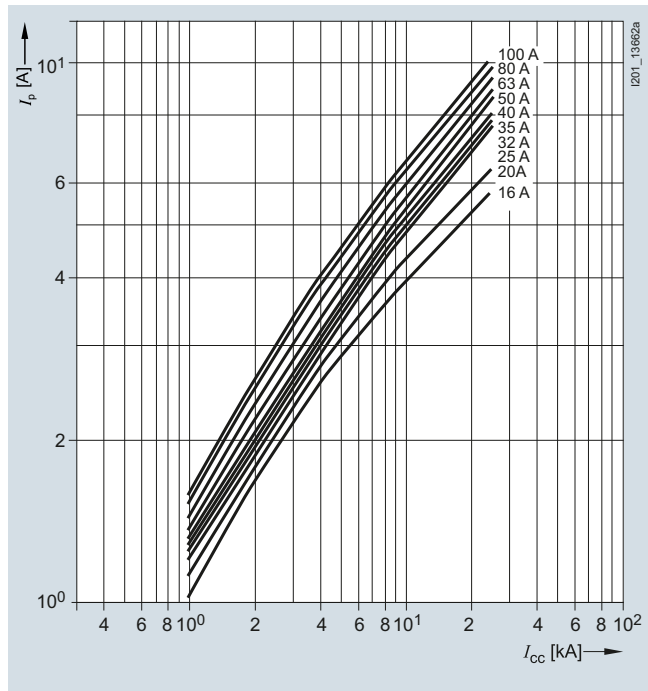

Let-through current I_{max} for SHU breakers

5SP3...-2; 5SP37...-2KK0.; 5SP3...-3; 16 ... 63 A

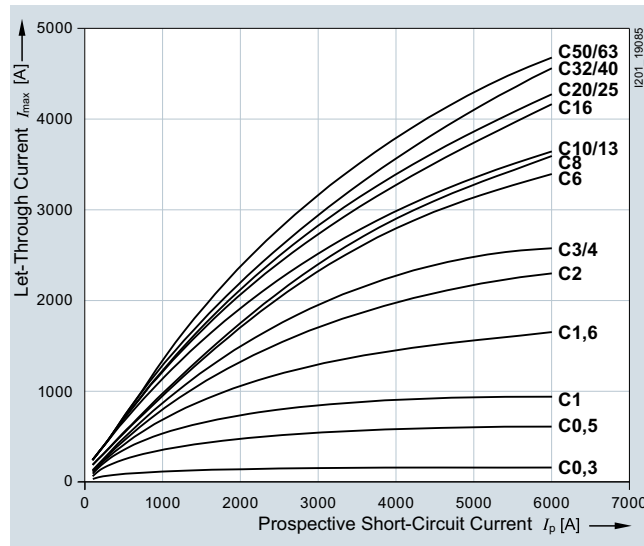

Miniature Circuit Breakers

SHU 5SP3 main miniature circuit breakers

Let-through current

5SP3...-3

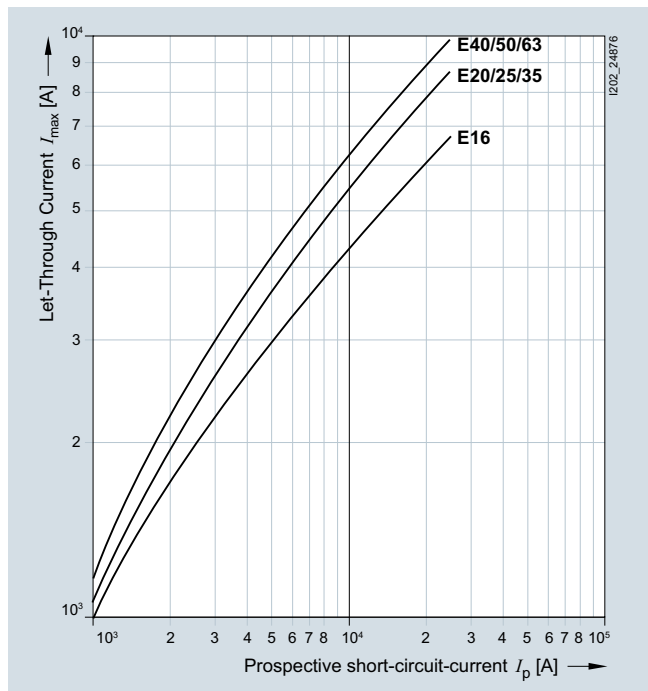

Let-through I^2t values

5SP3...-3

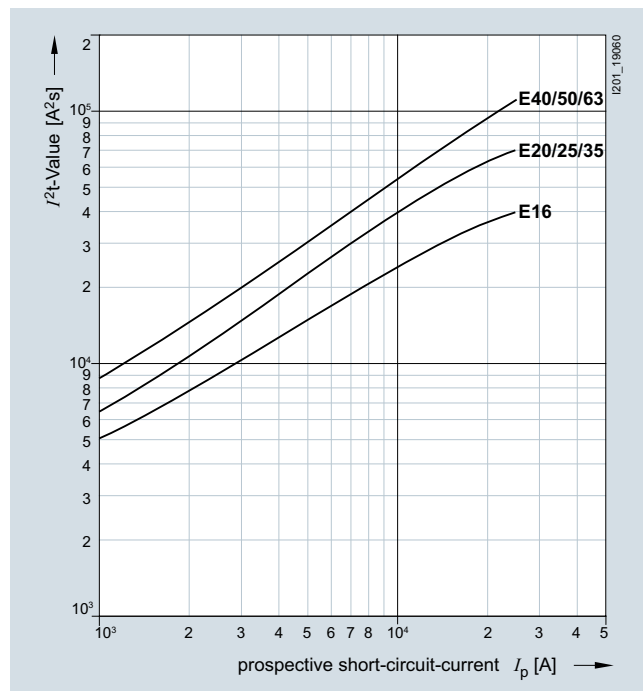

Let-through I^2t values

5SP37... , 5SP37...-1

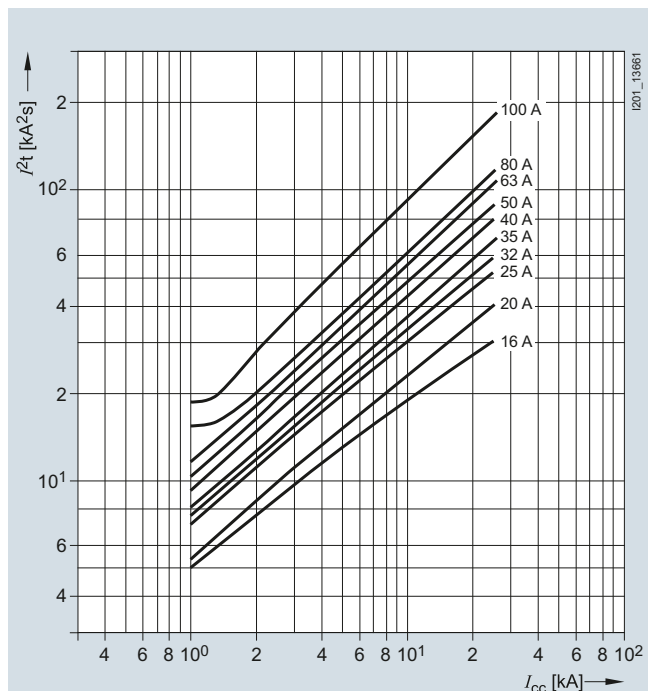

Let-through I^2t values for SHU breakers

5SP3...-2; 5SP37...-2KK0.; 5SP3...-3; 16 ... 63 A

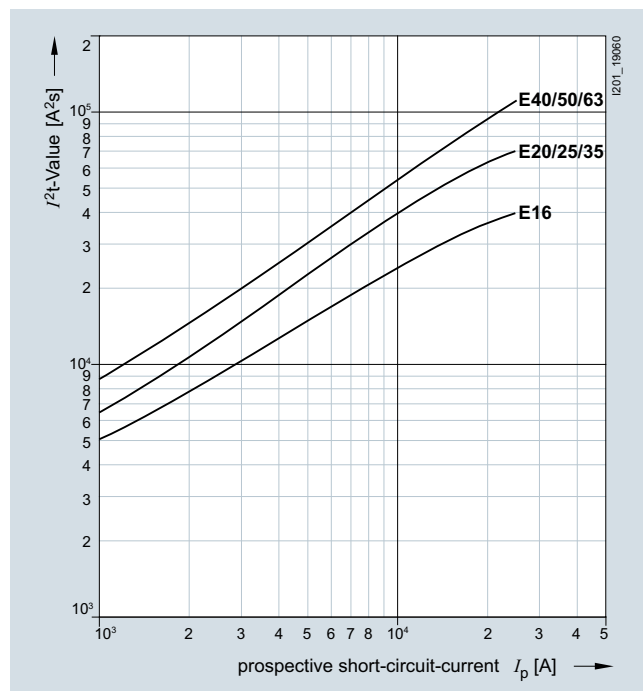

Dimensional drawings

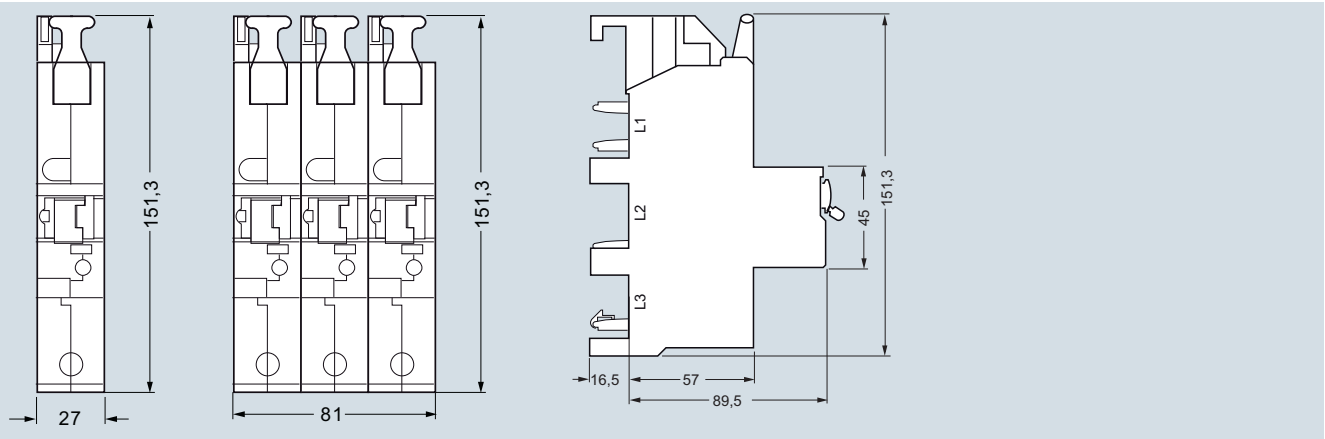

5SP37...-2
5SP37...-2KKO.
1P

5SP38...-2
3 x 1P

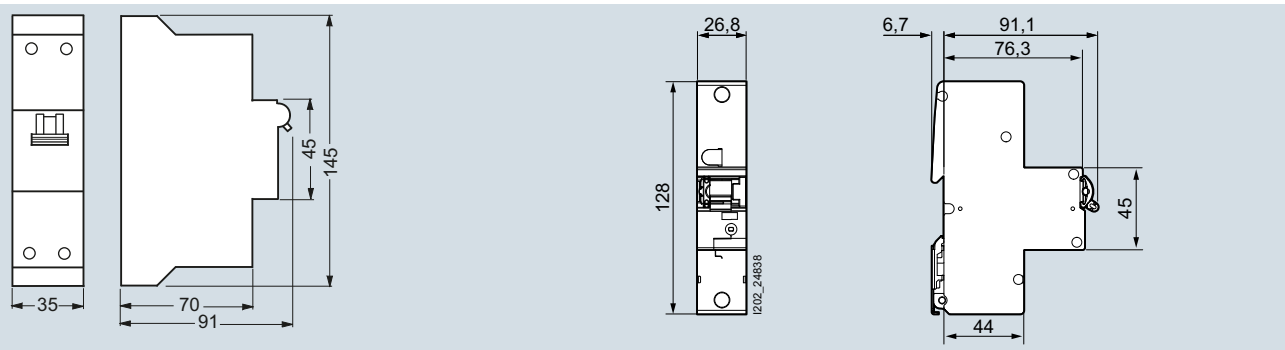

5SP37...
5SP37...-1

5SP37...-3
1P

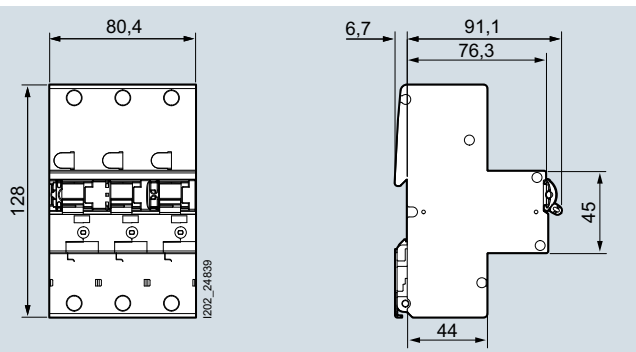

5SP38...-3
3 x 1P

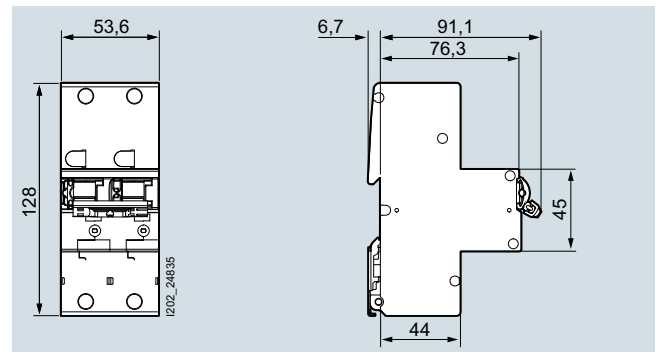

5SP32...-3
2P

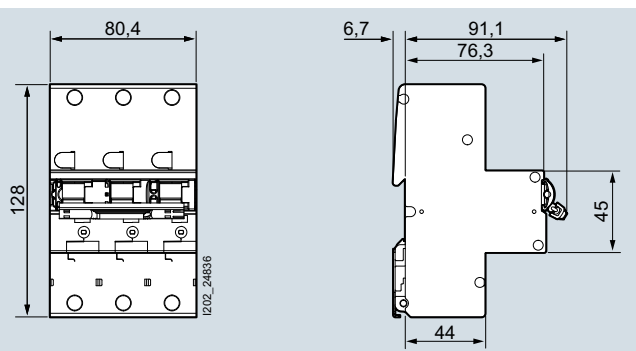

5SP33...-3
3P

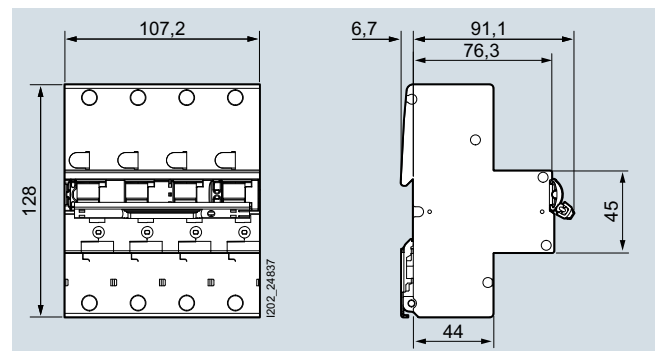

5SP34...-3
4P

Miniature Circuit Breakers

SHU 5SP3 main miniature circuit breakers

Circuit diagrams

Graphical symbols



5SP37...
5SP37...-1
5SP37...-2
5SP37...-3
5SP37...-2KK0.
1P



5SP38...-2
5SP38...-3

3 x 1P



5SP32...-3

2P



5SP33...-3

3P

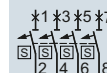

5SP34...-3



4P

Overview

Circuit breaker terminals are used for short-circuit protection or for protection against overload and short circuits in auxiliary and control circuits downstream of control transformers. All terminals are designed for 2 wires. The terminal block labeling accessories are used for inscription.

These devices are listed as "Supplementary Protectors" according to UL 1077 (UL Recognized Components) and CSA 235 (CSA Component Accepted).

Technical specifications

		5SK9011-1KK2., 5SK9011-2KK2.	5SK9011-4KK2., 5SK9011-6KK2., 5SK9011-8KK2.
Standards		DIN VDE 0660-101, IEC/EN 60947-2, UL 1077	
Rated operational voltage	Max.	AC DC	250 V at 50/60 Hz 60 V
Operational voltage	Min.	V AC/DC	24
Power losses			
Main contacts	Max.	W	1.3
Auxiliary contacts	Max.	mW	4.2 (at 1 A)
Through-type connection	Max.	mW	230 (at 16 A)
Rated impulse withstand voltage		kV	4
Pollution degree	Acc. to EN 60664-1		3
Rated current of through-type connection		A	16
Rated operational current of the auxiliary switch		A	1
Mechanical service life		Actuations	16000
Electrical service life on average, with rated load		Actuations	8000
Polarity with direct current			Any
Mounting position			Any
Resistance to vibrations			10 g at ≤ 70 Hz
Enclosure			With thermoplastic insulating body Screw connection at both ends for 2 conductors each Enclosed at both ends
Touch protection	Acc. to EN 50274-1		Yes
Mounting width		mm	12.5 22.5
Terminal tightening torque , recommended		Nm	0.8
Conductor cross-sections			
• Solid		mm ²	1 or 2 × (0,75 ... 1,5)
• Finely stranded, with end sleeve		mm ²	1 or 2 × (1 ... 2,5)
•  AWG 14-12			Yes --
•  AWG 14			Yes --
Stripped length		mm	10

Miniature Circuit Breakers

Circuit breaker terminals

Characteristic curves

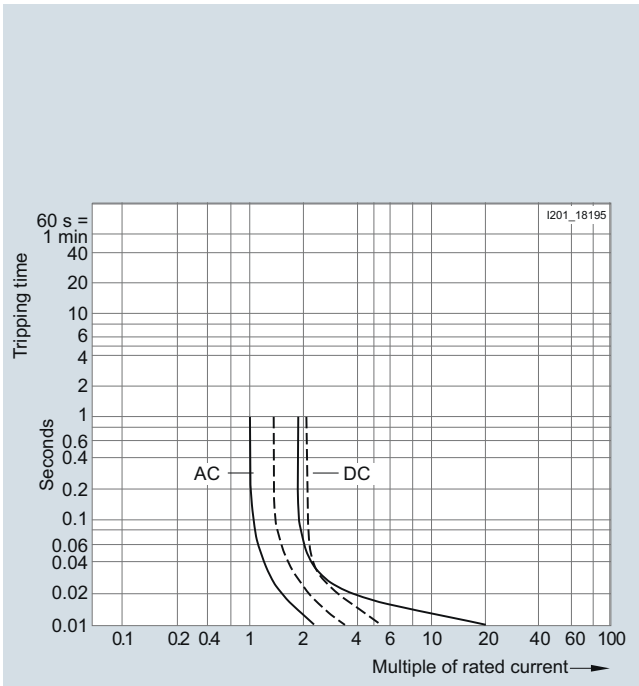

Tripping characteristics of short-circuit releases

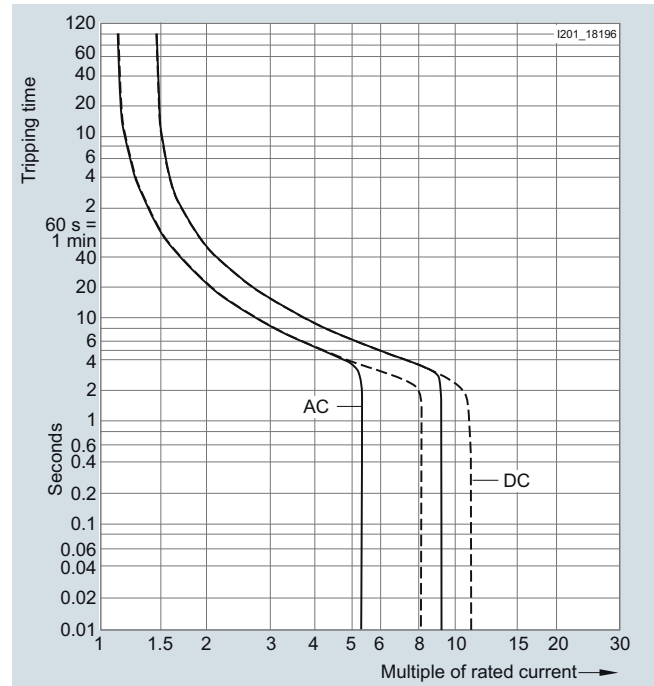

Tripping characteristics of combined overload and short-circuit releases

Dimensional drawings

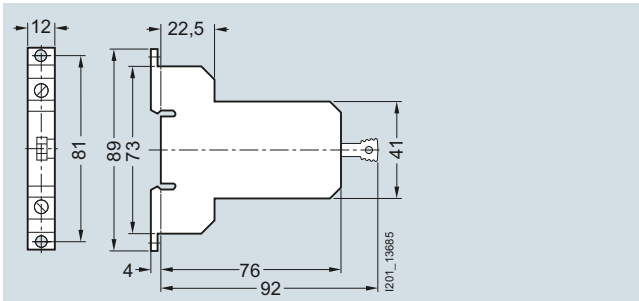

5SK9011-1KK2.
5SK9011-2KK2.

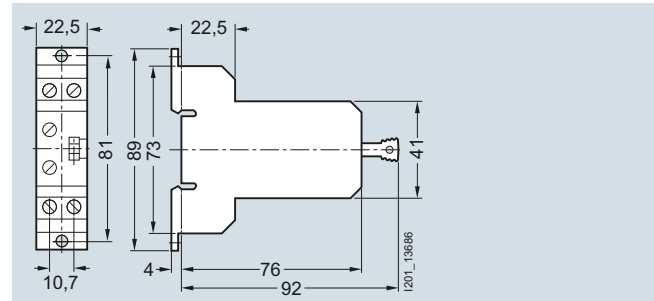

5SK9011-4KK2.
5SK9011-6KK2.
5SK9011-8KK2.

Circuit diagrams

Graphical symbols

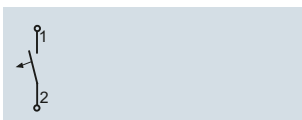

5SK9011-1KK2.

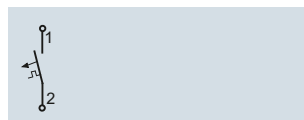

5SK9011-2KK2.

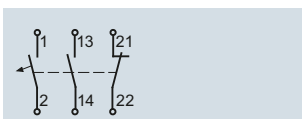

5SK9011-6KK2.

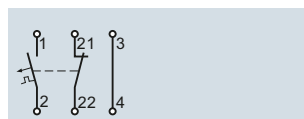

5SK9011-4KK2.

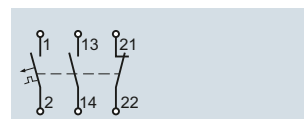

5SK9011-8KK2.

Siemens AG
Energy Management
Low Voltage & Products
Postfach 10 09 53
93009 REGENSBURG
GERMANY

Subject to change without prior notice
PDF (3ZW1012-5SL61-0AC1)
PH 0216 130 En
Produced in Germany
© Siemens AG 2016

The information provided in this brochure contains merely general descriptions or characteristics of performance which in case of actual use do not always apply as described or which may change as a result of further development of the products. An obligation to provide the respective characteristics shall only exist if expressly agreed in the terms of contract. Availability and technical specifications are subject to change without notice.

All product designations may be trademarks or product names of Siemens AG or supplier companies whose use by third parties for their own purposes could violate the rights of the owners.