

General Specifications

Electrical Capacity (Resistive Load)

Power Level: 10A @ 125/250V AC
6A @ 125/250V AC (UL/CSA)
5A (3A) @ 125/250V AC (VDE)

Other Ratings

Contact Resistance: 10 milliohms maximum
Insulation Resistance: 500 megohms minimum @ 500V DC
Dielectric Strength: 2,000V AC minimum between contacts for 1 minute minimum;
4,000V AC minimum between contacts & case for 1 minute minimum
Mechanical Life: 30,000 operations minimum
Electrical Life: 10,000 operations minimum
Nominal Operating Force: Single Pole 3.92N & Double Pole 5.39N
Angle of Throw: 30°

Materials & Finishes

Rocker: Polyphenylene ether (UL94V-0)
Housing/Case: Polyamide (UL94V-0)
Movable Contactor: Copper with silver plating
Movable Contacts: Silver
Stationary Contacts: Silver
End Terminals: Brass with silver plating
Common Terminals: Copper with silver plating
Lamp Terminals: Phosphor bronze with tin plating (illuminated models only)

Environmental Data

Operating Temp Range: -25°C through +70°C (-13°F through +158°F) for nonilluminated models;
-25°C through +50°C (-13°F through +122°F) for illuminated models
Humidity: 90 ~ 95% humidity for 96 hours @ 40°C (104°F)
Vibration: 10 ~ 55Hz with peak-to-peak amplitude of 1.5mm traversing the frequency range & returning in 15 minutes; 3 right angled directions for 2 hours
Shock: 50G (490m/s²) acceleration (tested in 6 right angled directions, with 5 shocks in each direction)
Sealing: Dust resistant inner seal

Installation

Soldering: Manual Soldering: See Profile A in Supplement section.
Cleaning: These devices are not process sealed. Hand cleaning locally using alcohol based solution.

Standards & Certifications

Flammability Standards: UL94V-0 for rocker & housing/case
UL: File No. E44145
All JWS models recognized at 6A @ 125/250V AC
CSA: File No. 023535_0_000
All JWS models certified at 6A @ 125/250V AC
VDE: License No. 119153
All JWS models approved at 5A (3A) @ 125/250V AC

Distinctive Characteristics

Rocker caps and housing available in a variety of colors.

Protective barrier available to prevent accidental actuation.

Constructed for dust resistance with interior cover of polyamide between actuator and contact area.

Easy, crisp actuation.

Small size well suited for telecommunication, measuring, automation, and consumer applications.

Terminals are molded in to lock out flux, dust, and other contaminants.

Outer case of heat resistant resin meets UL94V-0 flammability standard.

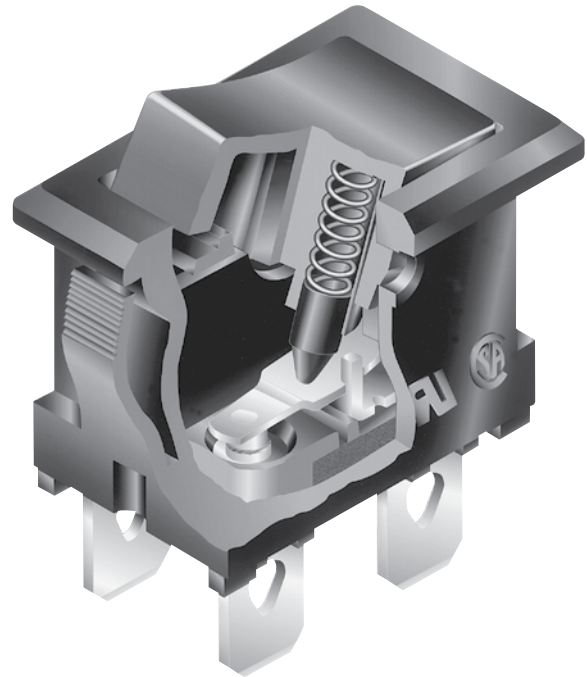

Actual Size

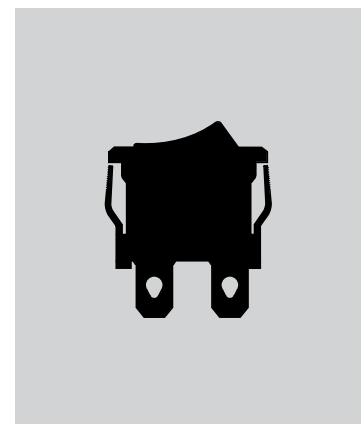

Supplement	Accessories	Indicators	Touch	Tilt	Tactiles	Slides	Rotaries	Keylocks	Programmable	Illuminated PB	Pushbuttons	Rockers	Toggle
------------	-------------	------------	-------	------	----------	--------	----------	----------	--------------	----------------	-------------	---------	--------

TYPICAL SWITCH ORDERING EXAMPLE

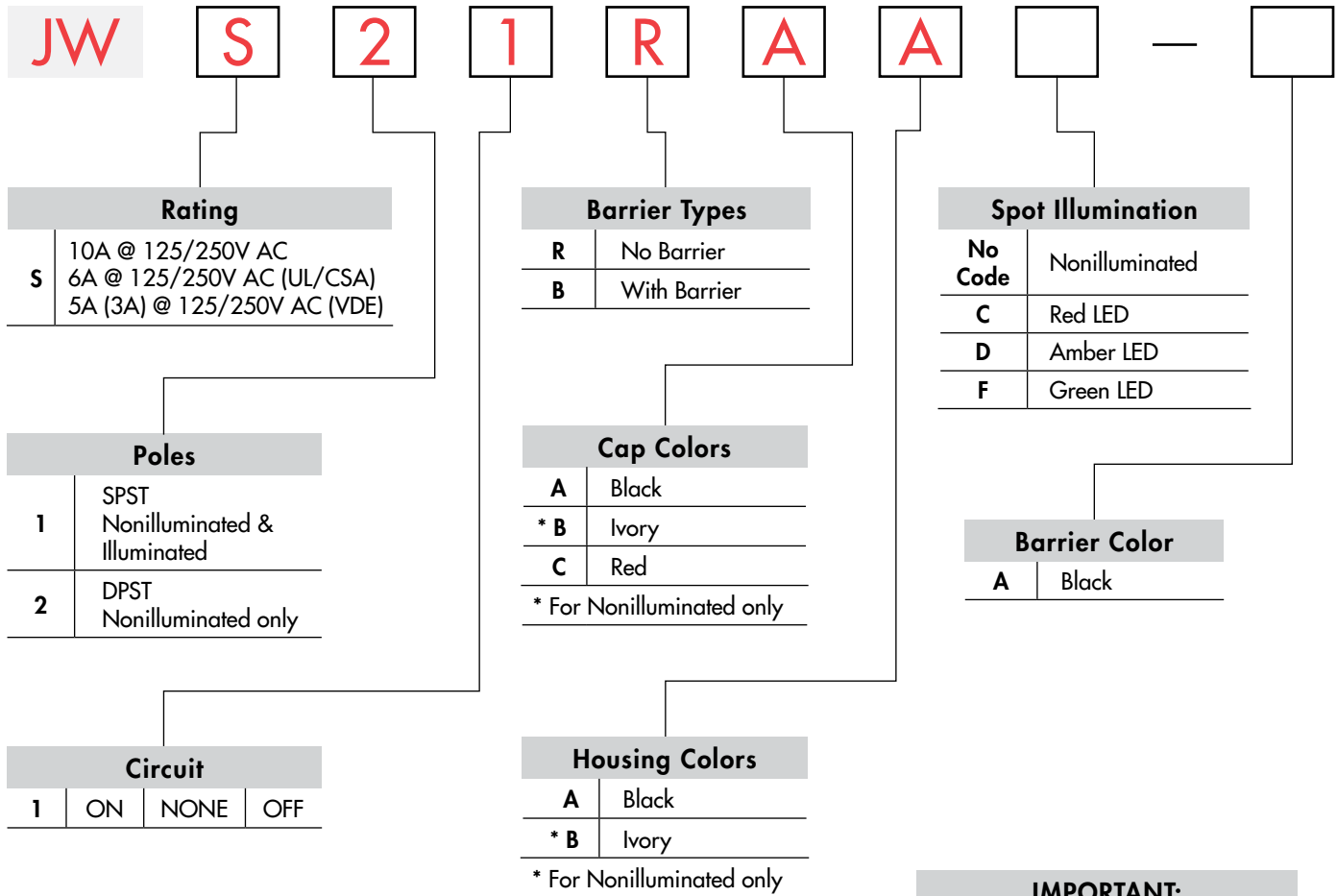

Note: Wire harness & cable assemblies offered only in Americas

IMPORTANT:

 cULus & VDE markings are standard on all models. Models & specific ratings are noted on General Specifications page.

DESCRIPTION FOR TYPICAL ORDERING EXAMPLE

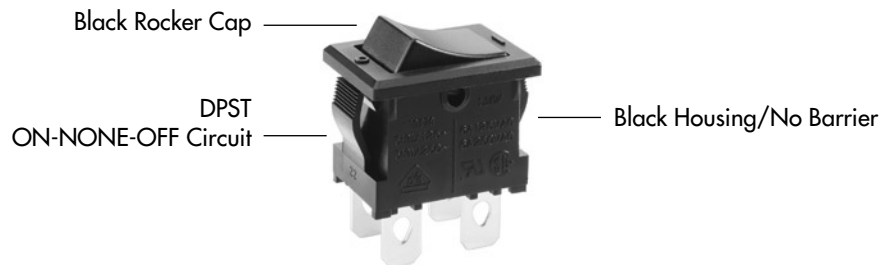
JWS21RAA





Toggles
 Rockers **B**
 Pushbuttons
 Illuminated PB
 Programmable
 Keylocks
 Rotaries
 Slides
 Tactiles
 Tilt
 Touch
 Indicators
 Accessories
 Supplement

RATING

S	Power Level	10A @ 125/250V AC	6A @ 125/250V AC (UL/CSA)	5A (3A) @ 125/250V AC (VDE)
----------	--------------------	-------------------	---------------------------	-----------------------------

POLES & CIRCUITS

Pole	Model	Rocker Position			Connected Terminals			Throw & Schematics
		Down	Center	Up	Down	Center	Up	
SP	JWS11	ON	NONE	OFF	2-3	OPEN	OPEN	SPST 
DP	JWS21	ON	NONE	OFF	1-3 4-6	OPEN	OPEN	DPST 

BARRIER TYPES & COLORS

R No Barrier

No-barrier type has a flat flange which is an integral part of the switch.



B With Barrier

Barrier Material: Polyamide
Finish: Matte

Barrier AT219 is factory assembled. Dimensions for barrier are shown in the Accessories section.



Barrier Color Available: **A** Black

CAP COLORS



Cap Material: Polyphenylene Oxide

Finish: Matte

Rocker cap is an integral part of the switch and not available separately.
* Ivory for nonilluminated models only.

Cap Colors Available:

A Black

B * Ivory

C Red

HOUSING

Material: Polyamide
Finish: Matte

Colors Available:

A Black

B Ivory (for nonilluminated models only)

TERMINALS

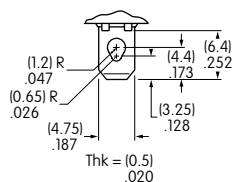

Switch

Solder Lug / .187" (4.75mm) Quick Connect

Switch assembly with connectors is not UL, CSA, C-UL, or VDE approved.

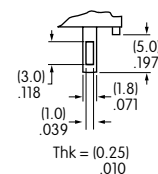

Lamp
(spot illuminated models only)

LED COLORS & SPECIFICATIONS FOR SPOT ILLUMINATED MODELS

LEDs are supplied as an integral part of illuminated devices and are not available separately. LED polarity markings are on the bottom of the switch.

The electrical specifications shown here are determined at a basic temperature of 25°C.

If the source voltage exceeds the rated voltage, a ballast resistor is required. The resistor value can be calculated by using the formula in the Supplement section.



		C	D	F
	Color	Red	Amber	Green
Forward Peak Current	I_{FM}	25mA	20mA	20mA
Continuous Forward Current	I_F	20mA	15mA	15mA
Forward Voltage	V_F	2.0V	1.9V	1.95V
Reverse Peak Voltage	V_{RM}	4V	5V	5V
Current Reduction Rate Above 25°C	ΔI_F	0.42mA/°C	0.27mA/°C	0.27mA/°C
Ambient Temperature Range		-25°C ~ +50°C		

PANEL CUTOUT & PANEL THICKNESS RANGES

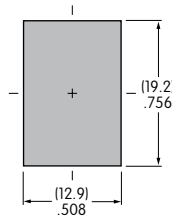

Panel Thickness Ranges:

Without Barrier:
.030" ~ .079" (0.75mm ~ 2.0mm)

With Barrier:
.024" ~ .059" (0.6mm ~ 1.5mm)

TYPICAL SWITCH DIMENSIONS

Nonilluminated • No Barrier

Single Pole

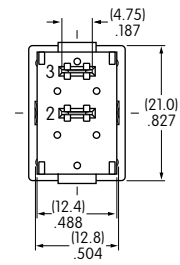
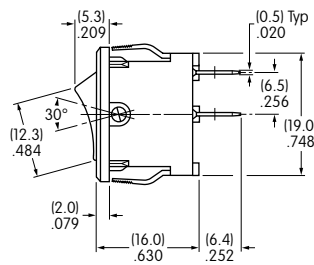
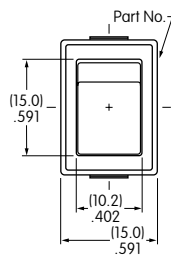

JWS11RCA

Nonilluminated • No Barrier

Double Pole

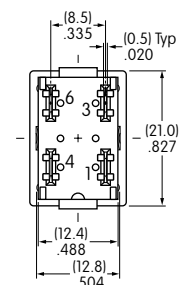
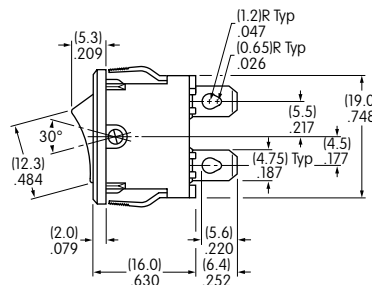
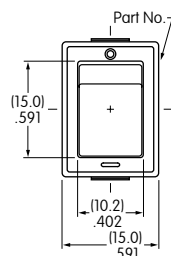

JWS21RAA

DPST models have IEC symbols for On-Off on the flange.

TYPICAL SWITCH DIMENSIONS

Single Pole

Nonilluminated • With Barrier

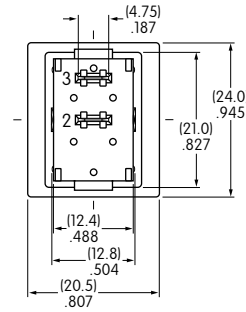
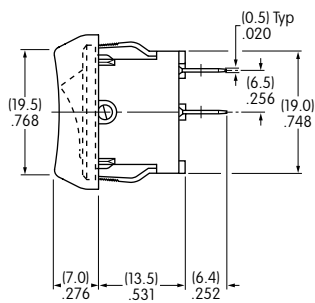
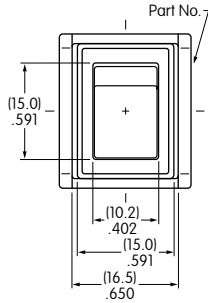

JWS11BBA-A

Double Pole

Nonilluminated • With Barrier

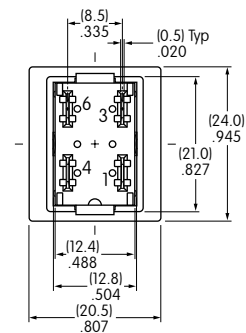
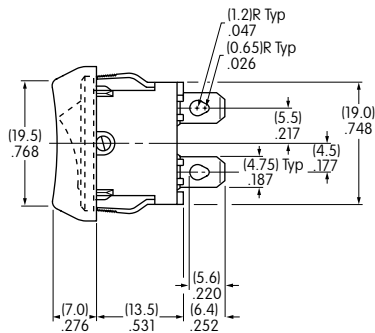
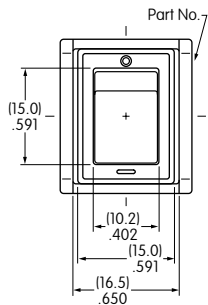

JWS21BAA-A

DPST models have IEC symbols for On-Off on the flange.

Single Pole

Spot Illuminated • No Barrier

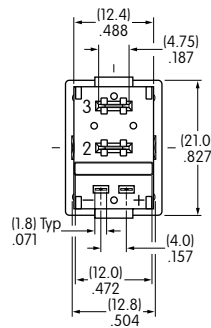
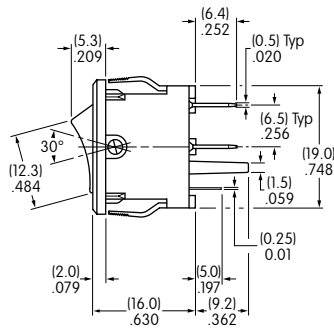
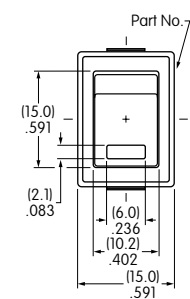

JWS11RCAF

Single Pole

Spot Illuminated • With Barrier

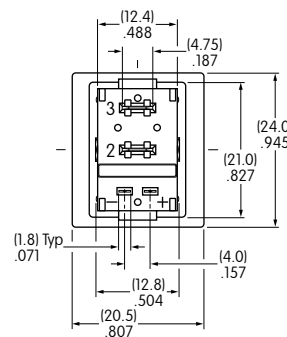
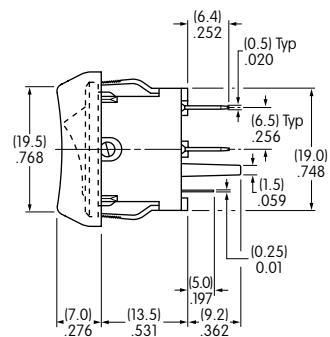
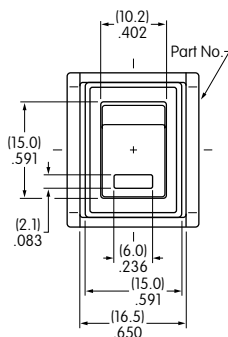

JWS11BAAF-A

Toggles

B Rockers

Pushbuttons

Illuminated PB

Programmable

Keylocks

Rotaries

Slides

Tactiles

Tilt

Touch

Indicators

Accessories

Supplement