

## Low drop power Schottky rectifier

### Main product characteristics

$I_{F(AV)}$	2 x 15 A
$V_{RRM}$	30 V
$T_j$ (max)	150° C
$V_F$ (max)	0.42 V

### Features and benefits

- Very small conduction losses
- Negligible switching losses
- Extremely fast switching
- Low forward voltage drop for higher efficiency
- Low thermal resistance
- Avalanche capability specified

### Description

Dual Schottky rectifier suited for switch mode power supply and high frequency DC to DC converters.

Packaged in TO-220AB, D<sup>2</sup>PAK and I<sup>2</sup>PAK, this device is intended for use in low voltage high frequency inverters, free-wheeling and polarity protection applications.

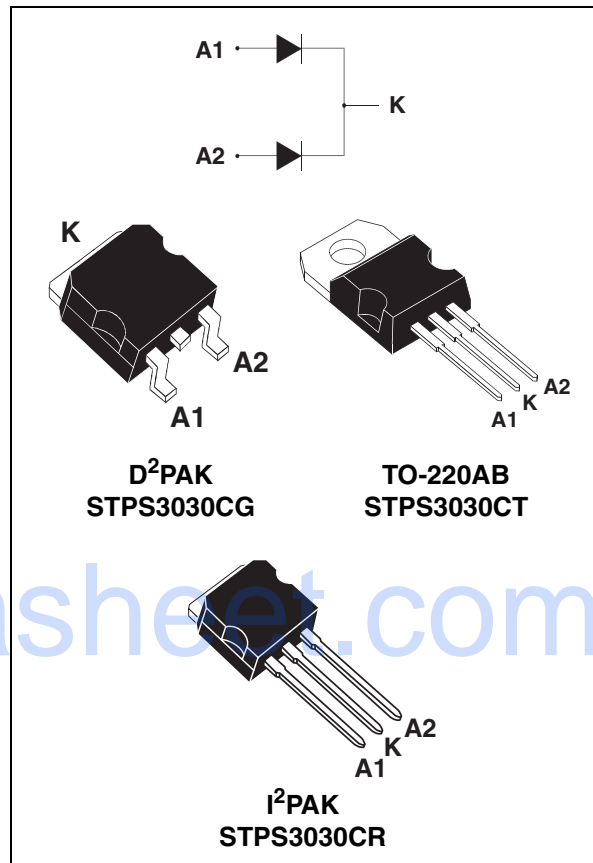

# 1 Characteristics

**Table 1. Absolute ratings (limiting values, per diode)**

Symbol	Parameter		Value	Unit
V <sub>RRM</sub>	Repetitive peak reverse voltage		30	V
I <sub>F(RMS)</sub>	RMS forward current		30	A
I <sub>F(AV)</sub>	Average forward current	T <sub>c</sub> = 135° C Per diode	15	A
		δ = 0.5 Per device	30	
I <sub>FSM</sub>	Surge non repetitive forward current	t <sub>p</sub> = 10 ms sinusoidal	250	A
I <sub>RRM</sub>	Peak repetitive reverse current	t <sub>p</sub> = 2 μs square F= 1 kHz	1	A
I <sub>RSM</sub>	Non repetitive peak reverse current	t <sub>p</sub> = 100 μs square	3	A
P <sub>ARM</sub>	Repetitive peak avalanche power	t <sub>p</sub> = 1 μs T <sub>j</sub> = 25° C	4100	W
T <sub>stg</sub>	Storage temperature range		-65 to + 150	°C
T <sub>j</sub>	Maximum operating junction temperature <sup>(1)</sup>		150	°C
dV/dt	Critical rate of rise of reverse voltage (rated V <sub>R</sub> , T <sub>j</sub> = 25° C)		10000	V/μs

1.  $\frac{dP_{tot}}{dT_j} < \frac{1}{R_{th(j-a)}}$  condition to avoid thermal runaway for a diode on its own heatsink

**Table 2. Thermal resistance**

Symbol	Parameter		Value	Unit
R <sub>th(j-c)</sub>	Junction to case TO-220AB - D <sup>2</sup> PAK - I <sup>2</sup> PAK	Per diode	1.2	°C/W
		Total	0.8	
R <sub>th(c)</sub>		Coupling	0.4	

**Table 3. Static electrical characteristics (per diode)**

Symbol	Parameter	Test conditions		Min.	Typ.	Max.	Unit
I <sub>R</sub> <sup>(1)</sup>	Reverse leakage current	T <sub>j</sub> = 25° C	V <sub>R</sub> = V <sub>RRM</sub>		0.23	1.0	mA
		T <sub>j</sub> = 125° C			125	180	
V <sub>F</sub> <sup>(1)</sup>	Forward voltage drop	T <sub>j</sub> = 25° C	I <sub>F</sub> = 15 A		0.44	0.49	V
		T <sub>j</sub> = 125° C	I <sub>F</sub> = 15 A		0.36	0.40	
		T <sub>j</sub> = 25° C	I <sub>F</sub> = 30 A		0.53	0.58	
		T <sub>j</sub> = 125° C	I <sub>F</sub> = 30 A		0.49	0.53	

1. Pulse test: t<sub>p</sub> = 380 μs, δ < 2%

To evaluate the conduction losses use the following equation:

$$P = 0.26 \times I_{F(AV)} + 0.0107 I_{F(RMS)}^2$$

Figure 1. Conduction losses versus average current

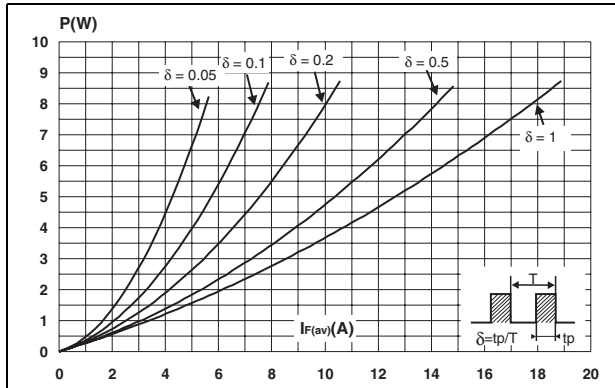

Figure 2. Average forward current versus ambient temperature ( $\delta = 0.5$ )

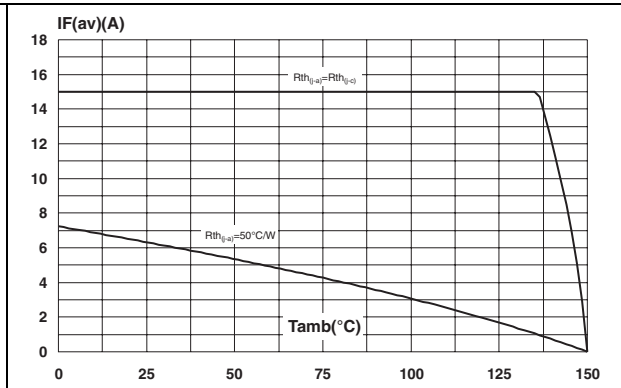

Figure 3. Normalized avalanche power derating versus pulse duration

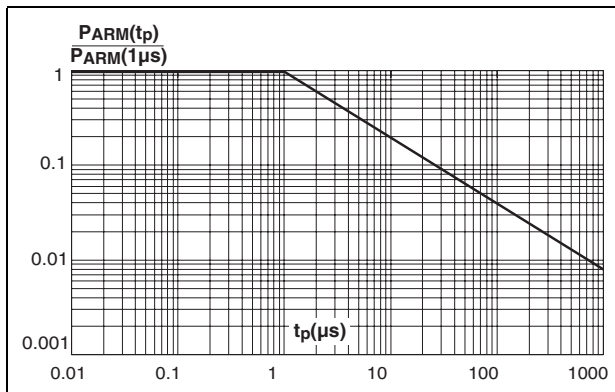

Figure 4. Normalized avalanche power derating versus junction temperature

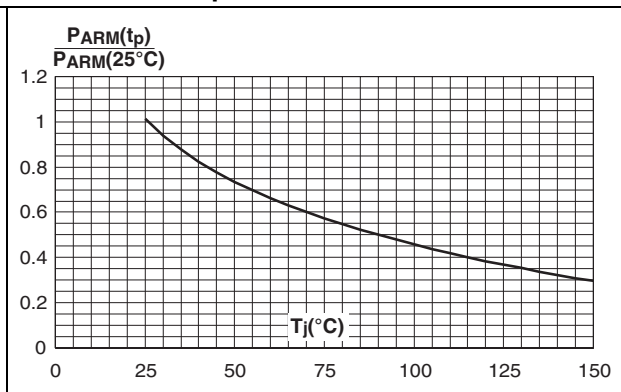

Figure 5. Non repetitive surge peak forward current versus overload duration (maximum values)

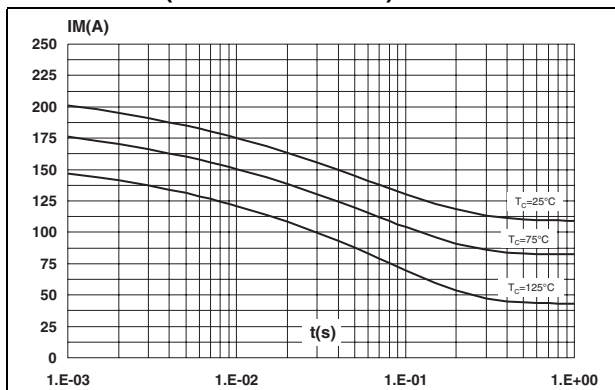
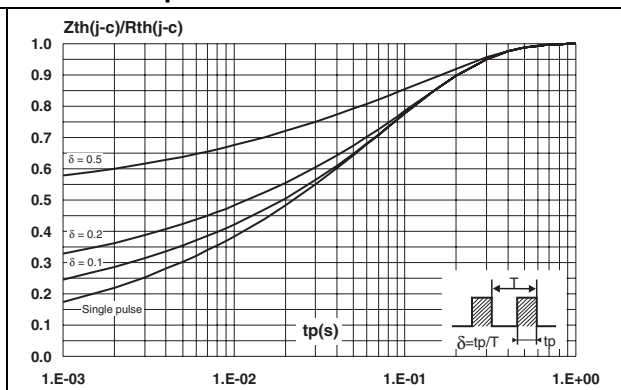
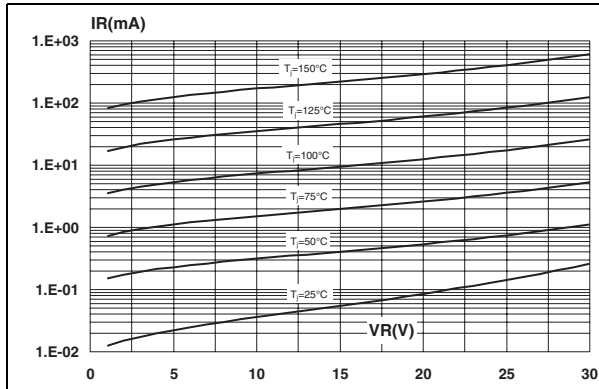

Figure 6. Relative variation of thermal impedance junction to case versus pulse duration



**Figure 7. Reverse leakage current versus reverse voltage applied (typical values)**



**Figure 8. Junction capacitance versus reverse voltage applied (typical values)**

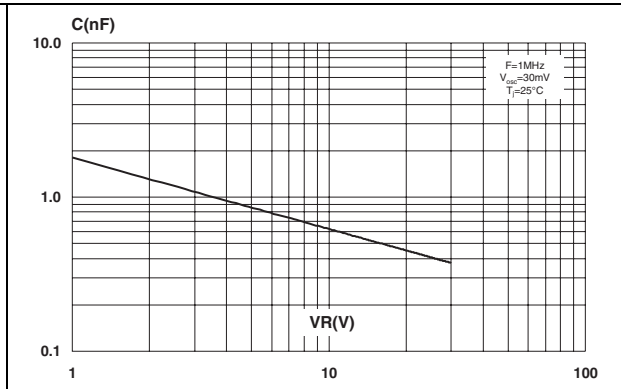

**Figure 9. Forward voltage drop versus forward current**

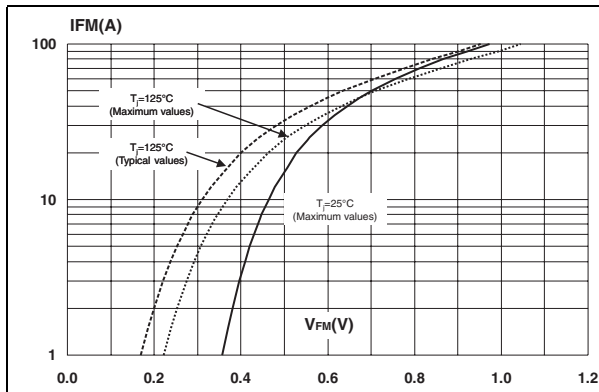

**Figure 10. Thermal resistance junction to ambient versus copper surface under tab (epoxy printed board FR4, Cu = 35 μm)**

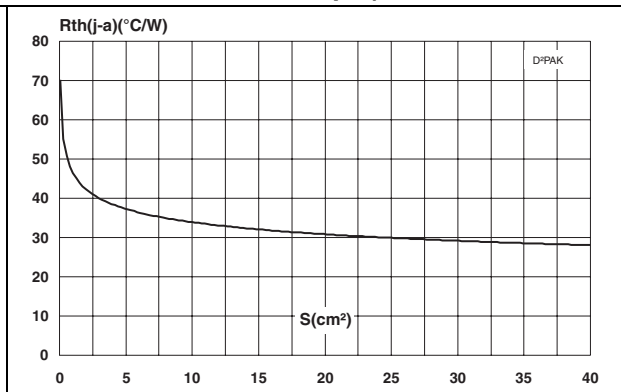

## 2 Package information

- Epoxy meets UL94,V0
- Cooling method: C
- Recommended torque value: 0.55 Nm
- Maximum torque value: 0.70 Nm

Table 4. I<sup>2</sup>PAK dimensions

Ref.	Dimensions			
	Millimeters		Inches	
	Min.	Max.	Min.	Max.
A	4.40	4.60	0.173	0.181
A1	2.40	2.72	0.094	0.107
b	0.61	0.88	0.024	0.035
b1	1.14	1.70	0.044	0.067
c	0.49	0.70	0.019	0.028
c2	1.23	1.32	0.048	0.052
D	8.95	9.35	0.352	0.368
e	2.40	2.70	0.094	0.106
e1	4.95	5.15	0.195	0.203
E	10	10.40	0.394	0.409
L	13	14	0.512	0.551
L1	3.50	3.93	0.138	0.155
L2	1.27	1.40	0.050	0.055

Table 5. D<sup>2</sup>PAK dimensions

Ref	Dimensions			
	Millimeters		Inches	
	Min.	Max.	Min.	Max.
A	4.40	4.60	0.173	0.181
A1	2.49	2.69	0.098	0.106
A2	0.03	0.23	0.001	0.009
B	0.70	0.93	0.027	0.037
B2	1.14	1.70	0.045	0.067
C	0.45	0.60	0.017	0.024
C2	1.23	1.36	0.048	0.054
D	8.95	9.35	0.352	0.368
E	10.00	10.40	0.393	0.409
G	4.88	5.28	0.192	0.208
L	15.00	15.85	0.590	0.624
L2	1.27	1.40	0.050	0.055
L3	1.40	1.75	0.055	0.069
M	2.40	3.20	0.094	0.126
R	0.40 typ.		0.016 typ.	
V2	0°	8°	0°	8°

Figure 11. Footprint (dimensions in millimeters)

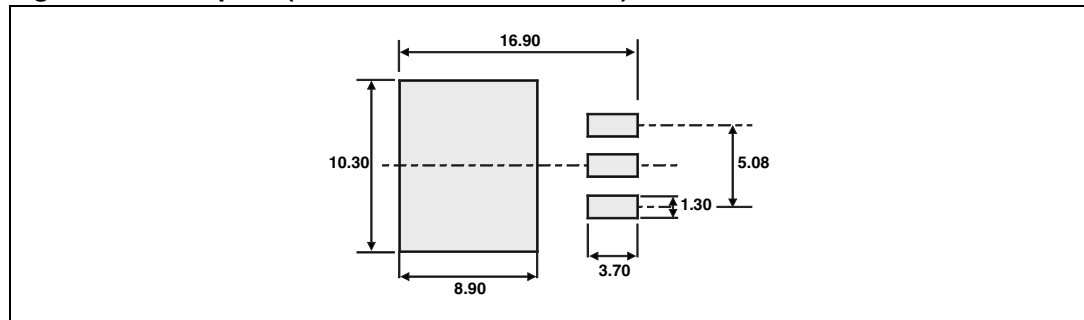
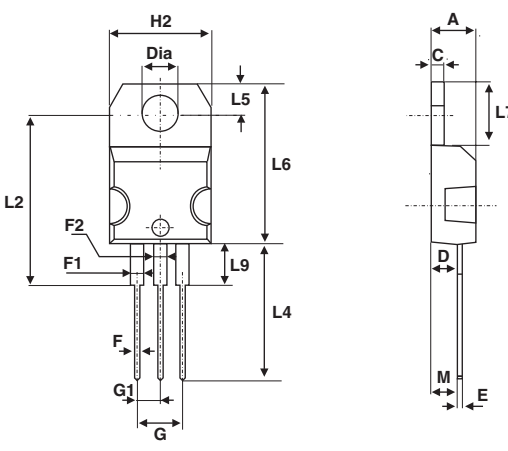

Table 6. TO-220AB dimensions



Ref	Dimensions			
	Millimeters		Inches	
	Min.	Max.	Min.	Max.
A	4.40	4.60	0.173	0.181
C	1.23	1.32	0.048	0.051
D	2.40	2.72	0.094	0.107
E	0.49	0.70	0.019	0.027
F	0.61	0.88	0.024	0.034
F1	1.14	1.70	0.044	0.066
F2	1.14	1.70	0.044	0.066
G	4.95	5.15	0.194	0.202
G1	2.40	2.70	0.094	0.106
H2	10	10.40	0.393	0.409
L2	16.4 typ.		0.645 typ.	
L4	13	14	0.511	0.551
L5	2.65	2.95	0.104	0.116
L6	15.25	15.75	0.600	0.620
L7	6.20	6.60	0.244	0.259
L9	3.50	3.93	0.137	0.154
M	2.6 typ.		0.102 typ.	
Diam	3.75	3.85	0.147	0.151

In order to meet environmental requirements, ST offers these devices in ECOPACK® packages. These packages have a lead-free second level interconnect. The category of second level interconnect is marked on the package and on the inner box label, in compliance with JEDEC Standard JESD97. The maximum ratings related to soldering conditions are also marked on the inner box label. ECOPACK is an ST trademark. ECOPACK specifications are available at: [www.st.com](http://www.st.com).

### 3 Ordering information

Ordering type	Marking	Package	Weight	Base qty	Delivery mode
STPS3030CT	STPS3030CT	TO-220AB	2.2 g	50	Tube
STPS3030CG	STPS3030CG	D <sup>2</sup> PAK	1.48 g	50	Tube
STPS3030CG-TR	STPS3030CG	D <sup>2</sup> PAK	1.48 g	1000	Tape and reel
STPS3030CR	STPS3030CR	I <sup>2</sup> PAK	1.49 g	50	Tube

### 4 Revision history

Date	Revision	Changes
Jul-2006	3A	Initial release.
16-Oct-2006	4	Reformatted to current standards. Corrected dimensions for I <sup>2</sup> PAK in Table 4



**Please Read Carefully:**

Information in this document is provided solely in connection with ST products. STMicroelectronics NV and its subsidiaries ("ST") reserve the right to make changes, corrections, modifications or improvements, to this document, and the products and services described herein at any time, without notice.

All ST products are sold pursuant to ST's terms and conditions of sale.

Purchasers are solely responsible for the choice, selection and use of the ST products and services described herein, and ST assumes no liability whatsoever relating to the choice, selection or use of the ST products and services described herein.

No license, express or implied, by estoppel or otherwise, to any intellectual property rights is granted under this document. If any part of this document refers to any third party products or services it shall not be deemed a license grant by ST for the use of such third party products or services, or any intellectual property contained therein or considered as a warranty covering the use in any manner whatsoever of such third party products or services or any intellectual property contained therein.

**UNLESS OTHERWISE SET FORTH IN ST'S TERMS AND CONDITIONS OF SALE ST DISCLAIMS ANY EXPRESS OR IMPLIED WARRANTY WITH RESPECT TO THE USE AND/OR SALE OF ST PRODUCTS INCLUDING WITHOUT LIMITATION IMPLIED WARRANTIES OF MERCHANTABILITY, FITNESS FOR A PARTICULAR PURPOSE (AND THEIR EQUIVALENTS UNDER THE LAWS OF ANY JURISDICTION), OR INFRINGEMENT OF ANY PATENT, COPYRIGHT OR OTHER INTELLECTUAL PROPERTY RIGHT.**

**UNLESS EXPRESSLY APPROVED IN WRITING BY AN AUTHORIZED ST REPRESENTATIVE, ST PRODUCTS ARE NOT RECOMMENDED, AUTHORIZED OR WARRANTED FOR USE IN MILITARY, AIR CRAFT, SPACE, LIFE SAVING, OR LIFE SUSTAINING APPLICATIONS, NOR IN PRODUCTS OR SYSTEMS WHERE FAILURE OR MALFUNCTION MAY RESULT IN PERSONAL INJURY, DEATH, OR SEVERE PROPERTY OR ENVIRONMENTAL DAMAGE. ST PRODUCTS WHICH ARE NOT SPECIFIED AS "AUTOMOTIVE GRADE" MAY ONLY BE USED IN AUTOMOTIVE APPLICATIONS AT USER'S OWN RISK.**

Resale of ST products with provisions different from the statements and/or technical features set forth in this document shall immediately void any warranty granted by ST for the ST product or service described herein and shall not create or extend in any manner whatsoever, any liability of ST.

ST and the ST logo are trademarks or registered trademarks of ST in various countries.

Information in this document supersedes and replaces all information previously supplied.

The ST logo is a registered trademark of STMicroelectronics. All other names are the property of their respective owners.

© 2006 STMicroelectronics - All rights reserved

STMicroelectronics group of companies

Australia - Belgium - Brazil - Canada - China - Czech Republic - Finland - France - Germany - Hong Kong - India - Israel - Italy - Japan - Malaysia - Malta - Morocco - Singapore - Spain - Sweden - Switzerland - United Kingdom - United States of America

[www.st.com](http://www.st.com)