

SUSSEX

SEMICONDUCTOR, INC.

12251 TOWN LAKE DRIVE, FORT MYERS, FLORIDA, 33913 • TEL: (941) 768-6800 • FAX: (941) 768-6868

**400 TO 1500 WATT UNIPOLAR
TRANSIENT SUPPRESSOR FLIP-
DIE**

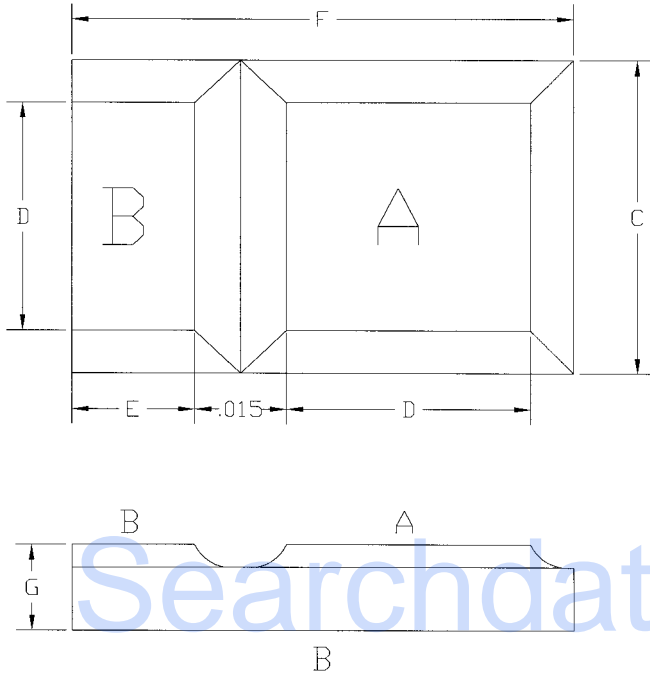

GLASS PASSIVATED SURFACE MOUNT UNIPOLAR FLIP-DIE

400 TO 5000 WATT MAXIMUM POWER HANDLING

REVERSE VOLTAGES - 6.8 TO 440 VOLTS

400 TO 1500 WATT UNIPOLAR FLIP-DIE SPECIFICATIONS

- ◆ Exclusive Sussex Semiconductor Flip-Die Technology
- ◆ Each Die Fully Glass Passivated: Needs No Encapsulation
- ◆ Space Saving Substitute For SMA, SMB, and SMC Packages
- ◆ Electrical Equivalent to P4KE, P6KE, SA, and 1.5KE Series Axial Leaded Devices
- ◆ Unipolar
- ◆ Each Device Individually Inspected
- ◆ Available in Waffle Packs or Tape and Reel
- ◆ Operating Temperature: -65 to 150°C
- ◆ Storage Temperature: -65 to 175°C
- ◆ Metallization: Ni-Ni-Au
- ◆ Polarity:

6.8 to 10 Breakdown Volts (V_{BR})	11 to 440 Breakdown Volts (V_{BR})
A-Cathode	A-Anode
B-Anode	B-Cathode

TABLE 3A - FLIP-DIE DIMENSION SPECIFICATIONS

◆ ALL TOLERANCES ARE $\pm .005$ ◆ ALL DIMENSIONS ARE IN INCHES

SIZE CODE	C	D	E	F	G
FD1.5	0.055	0.040	0.020	0.083	0.015
FD2	0.070	0.055	0.027	0.105	0.015
FD3	0.085	0.070	0.033	0.120	0.015
FD16	0.115	0.100	0.050	0.173	0.015

CUSTOM ORDERING SPECIFIER

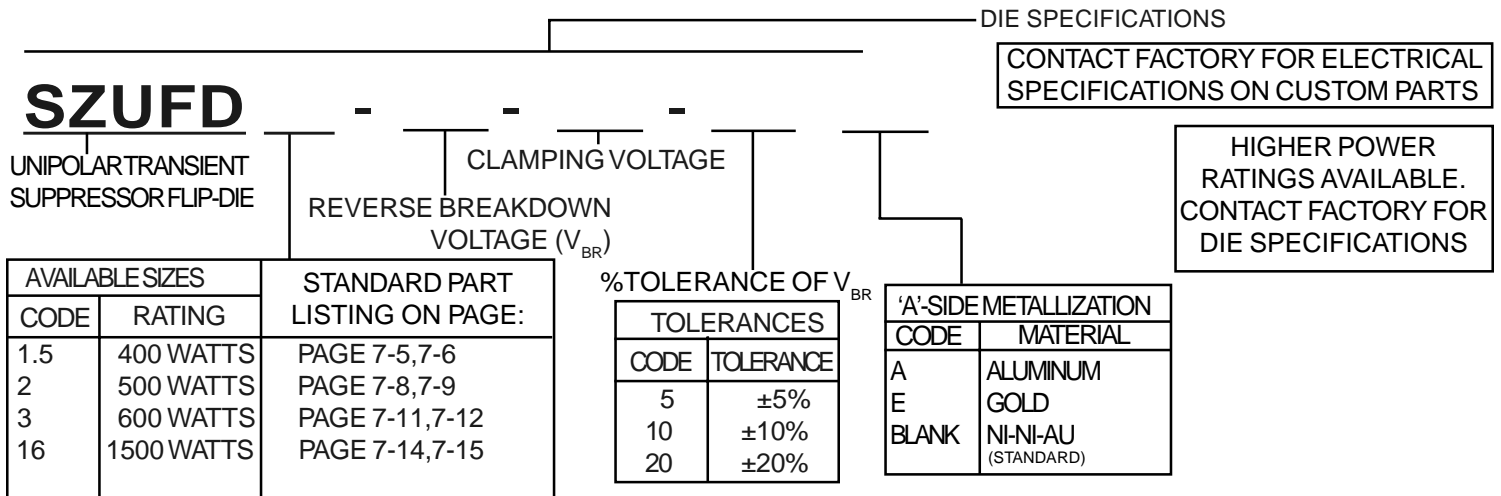



SUSSEX

SEMICONDUCTOR, INC.

12251 TOWN LAKE DRIVE, FORT MYERS, FLORIDA, 33913 • TEL: (941) 768-6800 • FAX: (941) 768-6868

**400 TO 1500 WATT BIPOLAR
TRANSIENT SUPPRESSOR
DUAL-DIE**

GLASS PASSIVATED SURFACE MOUNT BIPOLAR DUAL-DIE

400 TO 5000 WATT MAXIMUM POWER HANDLING

REVERSE VOLTAGES - 6.8 TO 440 VOLTS

400 TO 1500 WATT BIPOLAR DUAL-DIE SPECIFICATIONS

- ◆ Exclusive Sussex Semiconductor Dual-Die Technology
- ◆ Each Die Fully Glass Passivated: Needs No Encapsulation
- ◆ Space Saving Substitute For SMA, SMB, and SMC Packages
- ◆ Electrical Equivalent to P4KE, P6KE, SA, and 1.5KE Series Axial Leaded Devices
- ◆ Bipolar
- ◆ Each Device Individually Inspected
- ◆ Available in Waffle Packs or Tape and Reel
- ◆ Operating Temperature: -65 to 150°C
- ◆ Storage Temperature: -65 to 175°C
- ◆ Metallization: Ni-Ni-Au
- ◆ Polarity:

6.8 to 10 Breakdown Volts (V_{BR}) 11 to 440 Breakdown Volts (V_{BR})

A-Cathode

A-Anode

B-Anode

B-Cathode

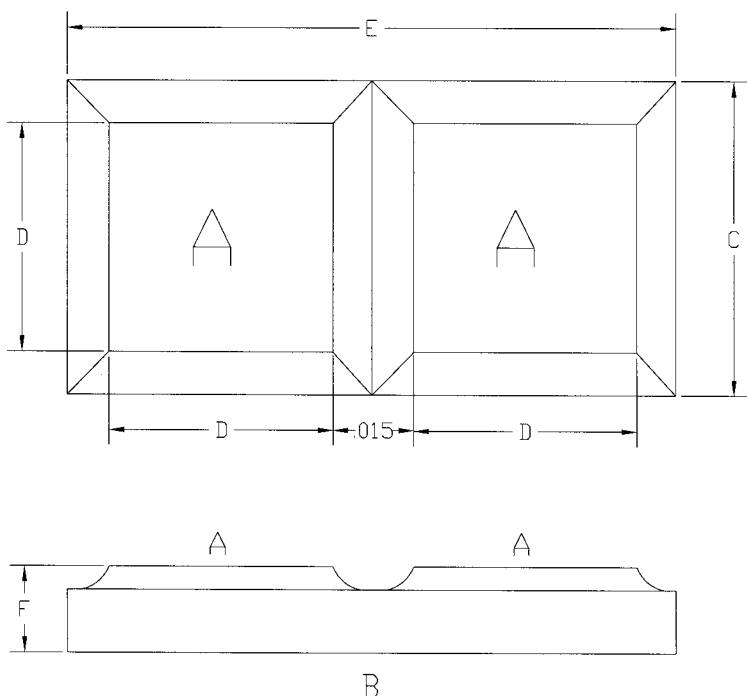

TABLE 4A - DUAL-DIE DIMENSION SPECIFICATIONS
 ♦ ALL TOLERANCES ARE $\pm .005"$ ♦ ALL DIMENSIONS ARE IN INCHES

SIZE CODE	C	D	E	F
D1.5	0.055	0.040	0.110	0.015
D2	0.070	0.055	0.140	0.015
D3	0.085	0.070	0.160	0.015
D16	0.115	0.100	0.230	0.015

CUSTOM ORDERING SPECIFIER

DIE SPECIFICATIONS

CONTACT FACTORY FOR ELECTRICAL SPECIFICATIONS ON CUSTOM PARTS

SZZD

BIPOLAR TRANSIENT SUPPRESSOR DUAL DIE

CLAMPING VOLTAGE
 REVERSE BREAKDOWN VOLTAGE (V_{BR}) (NOTE 1)

AVAILABLE SIZES		STANDARD PART LISTING ON PAGE:
CODE	RATING	
1.5	400 WATTS	PAGE 7-5, 7-6
2	500 WATTS	PAGE 7-8, 7-9
3	600 WATTS	PAGE 7-11, 7-12
16	1500 WATTS	PAGE 7-14, 7-15

% TOLERANCE OF V_{BR}

TOLERANCES	
CODE	TOLERANCE
5	±5%
10	±10%
20	±20%

'A'-SIDE METALLIZATION	
CODE	MATERIAL
A	ALUMINUM
E	GOLD
BLANK	NI-NI-AU (STANDARD)

NOTES
 NOTE 1: ♦ DUAL DIE V_{BR} IS MEASURED FROM A TO A. V_{BR} MEASURED FROM A TO B WILL RESULT IN A LOWER V_{BR} . CONTACT THE FACTORY FOR SPECIFIC INFORMATION.

HIGHER POWER RATINGS AVAILABLE.
 CONTACT FACTORY FOR DIE SPECIFICATIONS

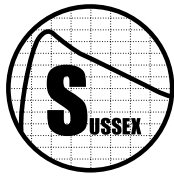

SUSSEX

SEMICONDUCTOR, INC.

12251 TOWNE LAKE DRIVE, FORT MYERS, FLORIDA, 33913 • TEL: (941) 768-6800 • FAX: (941) 768-6868

400 WATT TRANSIENT SUPPRESSOR DIE SPECIFICATIONS

TABLE 5A - 400 WATT TRANSIENT SUPPRESSOR DIE ELECTRICAL SPECIFICATIONS (NOTE 1)

INDUSTRY STANDARD PART NUMBERS (NOTE 2) 400 WATT P4KE SERIES	SUSSEX ORDER CODE REFER TO PAGE 7-7 FOR ORDER SPECIFIER	STANDOFF VOLTAGE (V _{SO}) Volts	MAX. REVERSE LEAKAGE (I _R) @ V _{SO} (NOTE 3) µA	REVERSE BREAKDOWN VOLTAGE (V _{BR}) @ I _T (NOTE 4)		TEST CURRENT (I _T) mA	MAX. CLAMPING VOLTAGE (V _{CL}) @ PEAK PULSE CURRENT (I _{PP}) (NOTE 5)		MAX. TEMP. COEFFICIENT OF V _{BR} (%/°C)
				MIN. Volts	MAX. Volts		V _{CL} Volts	I _{PP} Amps	
				P4KE6.8	6.8-10.8-10		5.50	1000	
P4KE6.8A	6.8-10.5-5	5.80	1000	6.45	7.14	10	10.5	40.0	0.057
P4KE7.5	7.5-11.7-10	6.05	500	6.75	8.25	10	11.7	35.0	0.061
P4KE7.5A	7.5-11.3-5	6.40	500	7.13	7.88	10	11.3	37.0	0.061
P4KE8.2	8.2-12.5-10	6.63	200	7.38	9.02	10	12.5	33.0	0.065
P4KE8.2A	8.2-12.1-5	7.02	200	7.79	8.61	10	12.1	34.0	0.065
P4KE9.1	9.1-13.8-10	7.37	50	8.19	10.00	1	13.8	30.0	0.068
P4KE9.1A	9.1-13.4-5	7.78	50	8.65	9.55	1	13.4	31.0	0.068
P4KE10	10-15.0-10	8.10	10	9.00	11.00	1	15.0	28.0	0.073
P4KE10A	10-14.5-5	8.55	10	9.50	10.50	1	14.5	29.0	0.073
P4KE11	11-16.2-10	8.92	5.0	9.90	12.10	1	16.2	26.0	0.075
P4KE11A	11-15.6-5	9.40	5.0	10.50	11.60	1	15.6	27.0	0.075
P4KE12	12-17.3-10	9.72	5.0	10.80	13.20	1	17.3	24.0	0.078
P4KE12A	12-16.7-5	10.20	5.0	11.40	12.60	1	16.7	25.0	0.078
P4KE13	13-19.0-10	10.50	5.0	11.70	14.30	1	19.0	22.0	0.061
P4KE13A	13-18.2-5	11.10	5.0	12.40	13.70	1	18.2	23.0	0.081
P4KE15	15-22.0-10	12.10	5.0	13.50	16.50	1	22.0	19.0	0.084
P4KE15A	15-21.2-5	12.80	5.0	14.30	15.80	1	21.2	20.0	0.084
P4KE16	16-23.5-10	12.90	5.0	14.40	17.60	1	23.5	17.8	0.086
P4KE16A	16-22.5-5	13.60	5.0	15.20	16.80	1	22.5	18.6	0.086
P4KE18	18-26.5-10	14.50	5.0	16.20	19.80	1	26.5	16.0	0.088
P4KE18A	18-25.2-5	15.30	5.0	17.10	18.90	1	25.2	16.5	0.088
P4KE20	20-29.1-10	16.20	5.0	18.00	22.00	1	29.1	14.0	0.090
P4KE20A	20-27.7-5	17.10	5.0	19.00	21.00	1	27.7	15.0	0.090
P4KE22	22-31.9-10	17.80	5.0	19.80	24.20	1	31.9	13.0	0.092
P4KE22A	22-30.6-5	18.80	5.0	20.90	23.10	1	30.6	13.7	0.092
P4KE24	24-34.7-10	19.40	5.0	21.60	26.40	1	34.7	12.0	0.091
P4KE24A	24-33.2-5	20.50	5.0	22.80	25.20	1	33.2	12.6	0.094
P4KE27	27-39.1-10	21.80	5.0	24.30	29.70	1	39.0	10.7	0.096
P4KE27A	27-37.5-5	23.10	5.0	25.70	28.40	1	37.5	11.0	0.096
P4KE30	30-43.5-10	24.30	5.0	27.00	33.00	1	43.5	9.6	0.097
P4KE30A	30-41.4-5	25.60	5.0	28.50	31.50	1	41.4	10.0	0.097
P4KE33	33-47.7-10	26.80	5.0	29.70	36.30	1	47.7	8.8	0.098
P4KE33A	33-45.7-5	28.20	5.0	31.40	34.70	1	45.7	9.0	0.098
P4KE36	36-52.0-10	29.10	5.0	32.40	39.60	1	52.0	8.0	0.099
P4KE36A	36-49.9-5	30.80	5.0	34.20	37.80	1	49.9	8.4	0.099
P4KE39	39-56.4-10	31.60	5.0	35.10	42.90	1	56.4	7.4	0.100
P4KE39A	39-53.9-5	33.30	5.0	37.10	41.00	1	53.9	7.7	0.100
P4KE43	43-61.9-10	34.80	5.0	38.70	47.30	1	61.9	6.7	0.101
P4KE43A	43-59.3-5	36.80	5.0	40.90	45.20	1	59.3	7.0	0.101
P4KE47	47-67.8-10	38.10	5.0	42.30	51.70	1	67.8	6.2	0.101
P4KE47A	47-64.8-5	40.20	5.0	44.70	49.40	1	64.8	6.4	0.101
P4KE51	51-70.1-10	41.30	5.0	45.90	56.10	1	73.5	5.7	0.102

THIS TABLE CONTINUES

NOTES

- NOTE 1:** ♦ ELECTRICAL CHARACTERISTICS ARE AT A JUNCTION TEMPERATURE (T_J) OF 25°C
- NOTE 2:** ♦ INDUSTRY STANDARD PART NUMBERS REFER TO PACKAGED DEVICES. THE DIES INDICATED BY THESE NUMBERS, IF PROPERLY PACKAGED, WILL OPERATE WITH THE SAME PERFORMANCE
- NOTE 3:** ♦ FOR BIPOLAR DEVICES WITH A V_{BR} OF 10 VOLTS OR LESS, THE I_R LIMIT IS DOUBLED
- NOTE 4:** ♦ DUAL DIE V_{BR} IS MEASURED FROM TOP TO TOP OF DIE. V_{BR} MEASURED FROM TOP TO BOTTOM WILL RESULT IN A LOWER V_{BR}
- NOTE 5:** ♦ SURGE CURRENT WAVEFORM SHOWN IN FIGURE 2A ON PAGE 7-7
♦ PEAK PULSE POWER DERATING SHOWN IN FIGURE 3A ON PAGE 7-7



SUSSEX

SEMICONDUCTOR, INC.

12251 TOWN LAKE DRIVE, FORT MYERS, FLORIDA, 33913 • TEL: (941) 768-6800 • FAX: (941) 768-6868

400 WATT TRANSIENT SUPPRESSOR DIE SPECIFICATIONS

TABLE 5A - 400 WATT TRANSIENT SUPPRESSOR DIE ELECTRICAL SPECIFICATIONS (NOTE 1)

INDUSTRY STANDARD PART NUMBERS (NOTE 2) 400 WATT P4KE SERIES	SUSSEX ORDER CODE REFER TO PAGE 7-7 FOR ORDER SPECIFIER	STANDOFF VOLTAGE (V _{SO}) Volts	MAX. REVERSE LEAKAGE (I _R) @ V _{SO} (NOTE 3) µA	REVERSE BREAKDOWN VOLTAGE (V _{BR}) @ I _R (NOTE 4)		TEST CURRENT (I _T) mA	MAX. CLAMPING VOLTAGE (V _{CL}) @ PEAK PULSE CURRENT (I _{PP}) (NOTE 5)		MAX. TEMP. COEFFICIENT OF V _{BR} (%/°C)
				MIN. Volts	MAX. Volts		V _{CL} Volts	I _{PP} Amps	
P4KE51A	51-70.1-5	43.60	5.0	48.50	53.60	1	70.1	6.0	0.102
P4KE56	56-80.5-10	45.40	5.0	50.40	61.60	1	80.5	5.2	0.103
P4KE56A	56-77.0-5	47.80	5.0	53.20	58.80	1	77.0	5.4	0.103
P4KE62	62-89.0-10	50.20	5.0	55.80	68.80	1	89.0	4.7	0.104
P4KE62A	62-85.0-5	53.00	5.0	58.90	65.10	1	85.0	5.0	0.104
P4KE68	68-96.0-10	55.10	5.0	61.20	74.80	1	96.0	4.2	0.104
P4KE68A	68-92.0-5	58.10	5.0	64.60	71.40	1	92.0	4.5	0.104
P4KE75	75-108.0-10	60.70	5.0	67.50	82.50	1	108.0	3.8	0.105
P4KE75A	75-103.0-5	64.10	5.0	71.30	78.80	1	103.0	4.0	0.105
P4KE82	82-118.0-10	66.40	5.0	73.80	90.20	1	118.0	3.5	0.105
P4KE82A	82-113.0-5	70.10	5.0	77.90	86.10	1	113.0	3.7	0.105
P4KE91	91-131.0-10	73.70	5.0	81.90	100.00	1	131.0	3.2	0.106
P4KE91A	91-125.0-5	77.80	5.0	86.50	95.50	1	125.0	3.3	0.106
P4KE100	100-144.0-10	81.00	5.0	90.00	110.00	1	144.0	2.9	0.106
P4KE100A	100-137.0-5	85.50	5.0	95.00	105.00	1	137.0	3.0	0.106
P4KE110	110-158.0-10	89.20	5.0	99.00	121.00	1	158.0	2.6	0.107
P4KE110A	110-152.0-5	94.00	5.0	105.00	116.00	1	152.0	2.7	0.107
P4KE120	120-173.0-10	97.20	5.0	108.00	132.00	1	173.0	2.4	0.107
P4KE120A	120-165.0-5	102.00	5.0	114.00	126.00	1	165.0	2.5	0.107
P4KE130	130-187.0-10	105.00	5.0	117.00	143.00	1	187.0	2.2	0.107
P4KE130A	130-179.0-5	111.00	5.0	124.00	137.00	1	179.0	2.3	0.107
P4KE150	150-215.0-10	121.00	5.0	135.00	165.00	1	215.0	1.9	0.108
P4KE150A	150-207.0-5	128.00	5.0	143.00	158.00	1	207.0	2.0	0.108
P4KE160	160-230.0-10	130.00	5.0	144.00	176.00	1	230.0	1.8	0.108
P4KE160A	160-219.0-5	136.00	5.0	152.00	168.00	1	219.0	1.9	0.108
P4KE170	170-244.0-10	138.00	5.0	153.00	187.00	1	244.0	1.7	0.108
P4KE170A	170-234.0-5	145.00	5.0	162.00	179.00	1	234.0	1.8	0.108
P4KE180	180-256.0-10	146.00	5.0	162.00	198.00	1	256.0	1.6	0.108
P4KE180A	180-246.0-5	154.00	5.0	171.00	189.00	1	246.0	1.7	0.108
P4KE200	200-287.0-10	162.00	5.0	180.00	220.00	1	287.0	1.4	0.108
P4KE200A	200-274.0-5	171.00	5.0	190.00	210.00	1	274.0	1.51	0.108
P4KE220	220-344.0-10	175.00	5.0	198.00	242.00	1	344.0	1.2	0.108
P4KE220A	220-328.0-5	185.00	5.0	209.00	231.00	1	328.0	1.3	0.108
P4KE250	250-360.0-10	202.00	5.0	225.00	275.00	1	360.0	1.1	0.110
P4KE250A	250-344.0-5	214.00	5.0	237.00	267.00	1	344.0	1.2	0.110
P4KE300	300-430.0-10	243.00	5.0	270.00	330.00	1	430.0	0.97	0.110
P4KE300A	300-414.0-5	256.00	5.0	285.00	315.00	1	414.0	1.0	0.110
P4KE350	350-504.0-10	284.00	5.0	315.00	385.00	1	504.0	0.83	0.110
P4KE350A	350-482.0-5	300.00	5.0	332.00	368.00	1	482.0	0.87	0.110
P4KE400	400-574.0-10	324.00	5.0	360.00	440.00	1	571.0	0.73	0.110
P4KE400A	400-548.0-5	342.00	5.0	380.00	420.00	1	548.0	0.76	0.110
P4KE440	440-598.0-10	356.00	5.0	396.00	484.00	1	598.0	0.66	0.110
P4KE440A	440-590.0-5	376.00	5.0	418.00	462.00	1	590.0	0.69	0.110

NOTES

- NOTE 1:** ♦ ELECTRICAL CHARACTERISTICS ARE AT A JUNCTION TEMPERATURE (T_J) OF 25°C
- NOTE 2:** ♦ INDUSTRY STANDARD PART NUMBERS REFER TO PACKAGED DEVICES. THE DIES INDICATED BY THESE NUMBERS, IF PROPERLY PACKAGED, WILL OPERATE WITH THE SAME PERFORMANCE
- NOTE 3:** ♦ FOR BIPOLAR DEVICES WITH A V_{BR} OF 10 VOLTS OR LESS, THE I_R LIMIT IS DOUBLED
- NOTE 4:** ♦ DUAL DIE V_{BR} IS MEASURED FROM TOP TO TOP OF DIE V_{BR}. MEASURED FROM TOP TO BOTTOM WILL RESULT IN A LOWER V_{BR}
- NOTE 5:** ♦ SURGE CURRENT WAVEFORM SHOWN IN FIGURE 1A ON PAGE 7-7
♦ PEAK PULSE POWER DERATING SHOWN IN FIGURE 2A ON PAGE 7-7

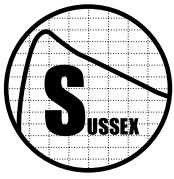

SUSSEX

SEMICONDUCTOR, INC.

12251 TOWN LAKE DRIVE, FORT MYERS, FLORIDA, 33913 • TEL: (941) 768-6800 • FAX: (941) 768-6868

**400 WATT DIE SPECIFICATIONS
CONTINUED**

ORDERING SPECIFIER

6.8 - 10.8 - 10

ORDER CODE FROM
PREVIOUS PAGES

TABLE 6A - AVAILABLE DIE SIZES

CODE	DIE TYPE	DIE SPECIFICATIONS REFER TO:
SZU1.5	400 WATT UNIPOLAR DIE	PAGE 7-1
SZZ1.5	400 WATT BIPOLAR DIE	PAGE 7-2
SZUFD1.5	400 WATT UNIPOLAR FLIP-DIE	PAGE 7-3
SZZD1.5	400 WATT BIPOLAR DUAL-DIE	PAGE 7-4

FIGURE 1A - TYPICAL JUNCTION CAPACITANCE

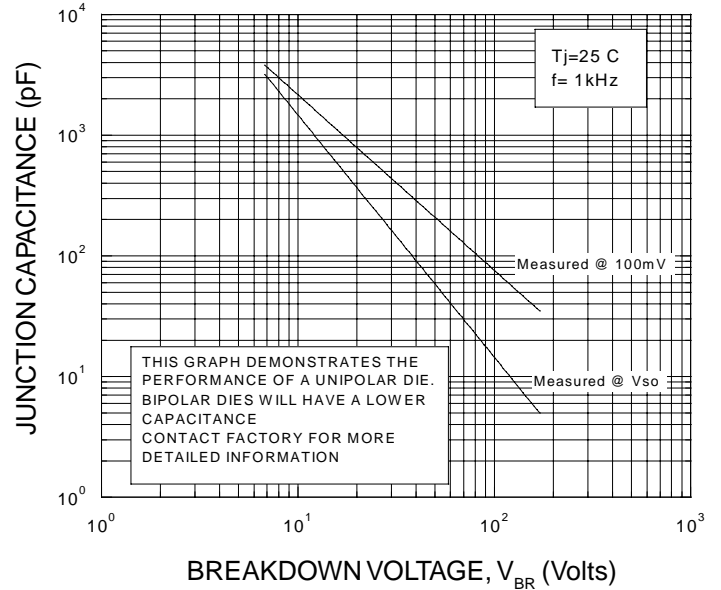

FIGURE 2A - PULSE WAVEFORM

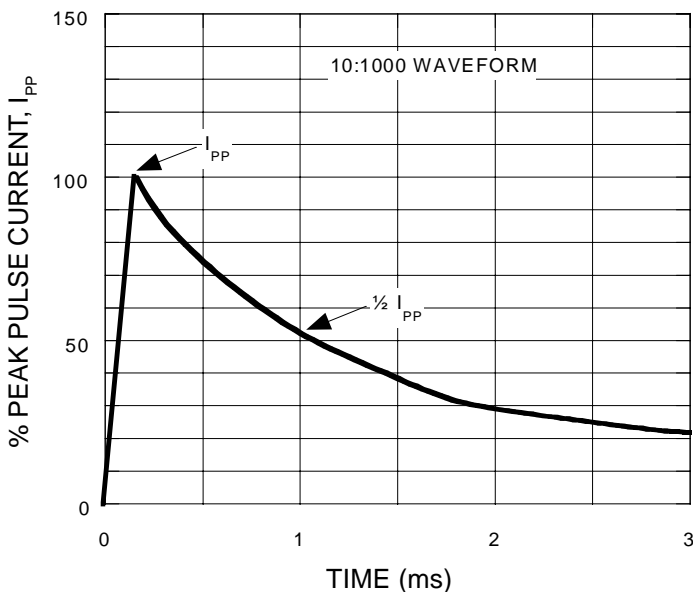
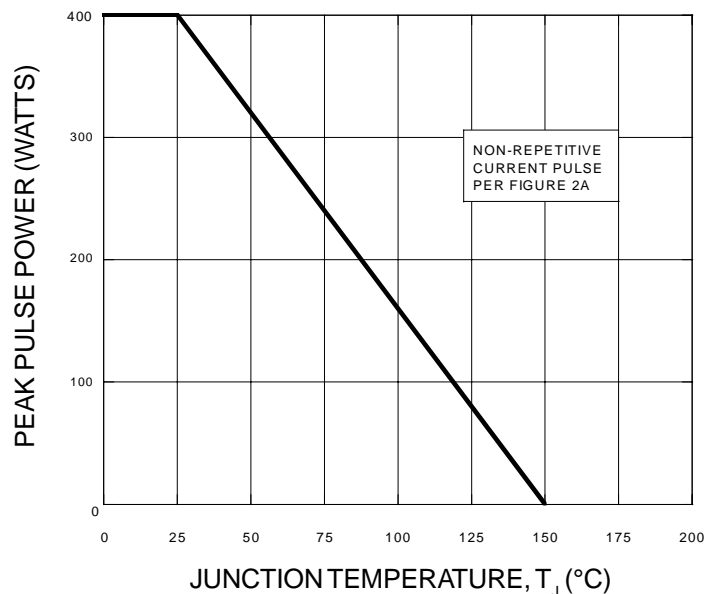

FIGURE 3A - PULSE DERATING CURVE





SUSSEX

SEMICONDUCTOR, INC.

12251 TOWNE LAKE DRIVE, FORT MYERS, FLORIDA, 33913 • TEL: (941) 768-6800 • FAX: (941) 768-6868

500 WATT TRANSIENT SUPPRESSOR DIE SPECIFICATIONS

TABLE 7A - 500 WATT TRANSIENT SUPPRESSOR DIE ELECTRICAL SPECIFICATIONS (NOTE 1)

INDUSTRY STANDARD PART NUMBERS (NOTE 2) 500 WATT SA SERIES	SUSSEX ORDER CODE REFER TO PAGE 7-10 FOR ORDER SPECIFIER	STANDOFF VOLTAGE (V _{SO}) Volts	MAX. REVERSE LEAKAGE (I _R) @ V _{SO} (NOTE 3) µA	REVERSE BREAKDOWN VOLTAGE (V _{BR}) @ I _T (NOTE 4)		TEST CURRENT (I _T) mA	MAX. CLAMPING VOLTAGE (V _{CL}) @ PEAK PULSE CURRENT (I _{PP}) (NOTE 5)		MAX. TEMP. COEFFICIENT OF V _{BR} (mV/°C)
				MIN. Volts	MAX. Volts		V _{CL} Volts	I _{PP} Amps	
				SA5.0	6.8-9.6-6.5		5	600	
SA5.0A	6.7-9.2-4.4	5	600	6.4	7.0	10	9.2	57.0	5.00
SA6.0	6.4-11.4-9.9	6	600	6.7	8.2	10	11.4	46.0	5.00
SA6.0A	7.0-10.3-4.9	6	600	6.7	7.4	10	10.3	50.0	5.00
SA6.5	8.0-12.3-9.9	6.5	400	7.2	8.8	10	12.3	42.0	5.00
SA6.5A	7.6-11.2-5	6.5	400	7.2	8.0	10	11.2	46.0	5.00
SA7.0	8.6-13.3-10	7	150	7.8	9.5	10	13.3	39.0	6.00
SA7.0A	8.1-12-5	7	150	7.8	8.6	10	12.0	43.0	6.00
SA7.5	9.2-14.3-10	7.5	50	8.3	10.2	1	14.3	36.0	7.00
SA7.5A	8.7-12.9-5	7.5	50	8.3	9.2	1	12.9	40.0	7.00
SA8.0	9.8-15-10	8	25	8.9	10.9	1	15.0	35.0	7.00
SA8.0A	9.3-13.6-5	8	25	8.9	9.8	1	13.6	38.0	7.00
SA8.5	10.4-15.9-9.8	8.5	10	9.4	11.5	1	15.9	33.0	8.00
SA8.5A	9.9-14.4-4.8	8.5	10	9.4	10.4	1	14.4	36.0	8.00
SA9	11.1-16.9-9.9	9	5	10.0	12.2	1	16.9	31.0	9.00
SA9.0A	10.5-15.4-5.2	9	5	10.0	11.1	1	15.4	34.0	9.00
SA10	12.3-18.8-10	10	1	11.1	13.6	1	18.8	27.0	10.00
SA10A	11.7-17-5.1	10	1	11.1	12.3	1	17.0	30.0	10.00
SA11	13.5-20.1-9.9	11	1	12.2	14.9	1	20.1	26.0	11.00
SA11A	12.8-18.2-5	11	1	12.2	13.5	1	18.2	28.0	11.00
SA12	14.8-22-10	12	1	13.3	16.3	1	22.0	23.0	12.00
SA12A	14-19.9-5	12	1	13.3	14.7	1	19.9	26.3	12.00
SA13	16-23.8-10	13	1	14.4	17.6	1	23.8	22.0	13.00
SA13A	15.1-21.5-4.9	13	1	14.4	15.9	1	21.5	24.0	13.00
SA14	17.3-25.8-10	14	1	15.6	19.1	1	25.8	20.3	14.00
SA14A	16.4-23.2-4.8	14	1	15.6	17.2	1	23.2	22.6	14.00
SA15	18.5-26.9-9.9	15	1	16.7	20.4	1	26.9	19.5	16.00
SA15A	17.6-24.4-5.1	15	1	16.7	18.5	1	24.4	21.0	16.00
SA16	19.8-28.8-10.1	16	1	17.8	21.8	1	28.8	18.0	19.00
SA16A	18.7-26-5	16	1	17.8	19.7	1	26.0	20.0	17.00
SA17	21-30.5-10	17	1	18.9	23.1	1	30.5	17.0	20.00
SA17A	19.9-27.6-5	17	1	18.9	20.9	1	27.6	19.0	19.00
SA18	22.2-32.2-9.9	18	1	20.0	24.4	1	32.2	16.3	21.00
SA18A	21.0-29.2-4.9	18	1	20.0	22.1	1	29.2	17.9	20.00
SA20	24.6-35.8-9.9	20	1	22.2	27.1	1	35.8	14.0	25.00
SA20A	23.3-32.4-4.9	20	1	22.2	24.5	1	32.4	16.0	23.00
SA22	27.1-39.4-9.9	22	1	24.4	29.8	1	39.4	13.0	28.00
SA22A	25.6-35.5-4.8	22	1	24.4	26.9	1	35.5	14.7	25.00
SA24	29.6-43-9.9	24	1	26.7	32.6	1	43.0	12.0	31.00
SA24A	28.1-38.9-4.9	24	1	26.7	29.5	1	38.9	13.4	28.00
SA26	32.1-46.6-9.9	26	1	28.9	35.3	1	46.6	11.0	31.00
SA26A	30.4-42.1-4.9	26	1	28.9	31.9	1	42.1	12.4	30.00
SA28	34.5-50.1-9.9	28	1	31.1	38.0	1	50.1	10.0	35.00
SA28A	32.7-45.4-5	28	1	31.1	34.4	1	45.4	11.5	31.00
SA30	37-53.5-10	30	1	33.3	40.7	1	53.5	9.8	39.00
SA30A	35.0-48.4-4.9	30	1	33.3	36.8	1	48.4	10.8	36.00

THIS TABLE CONTINUES

NOTES

- NOTE 1:** ♦ ELECTRICAL CHARACTERISTICS ARE AT A JUNCTION TEMPERATURE (T_J) OF 25°C
- NOTE 2:** ♦ INDUSTRY STANDARD PART NUMBERS REFER TO PACKAGED DEVICES. THE DIES INDICATED BY THESE NUMBERS, IF PROPERLY PACKAGED, WILL OPERATE WITH THE SAME PERFORMANCE
- NOTE 3:** ♦ FOR BIPOLAR DEVICES WITH A V_{BR} OF 10 VOLTS OR LESS, THE I_R LIMIT IS DOUBLED
- NOTE 4:** ♦ DUAL DIE V_{BR} IS MEASURED FROM TOP TO TOP OF DIE V_{BR} MEASURED FROM TOP TO BOTTOM WILL RESULT IN A LOWER V_{BR}
- NOTE 5:** ♦ SURGE CURRENT WAVEFORM SHOWN IN FIGURE 2A ON PAGE 7-10
♦ PEAK PULSE POWER DERATING SHOWN IN FIGURE 3A ON PAGE 7-10

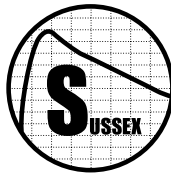

SUSSEX

SEMICONDUCTOR, INC.

12251 TOWNE LAKE DRIVE, FORT MYERS, FLORIDA, 33913 • TEL: (941) 768-6800 • FAX: (941) 768-6868

500 WATT TRANSIENT SUPPRESSOR DIE SPECIFICATIONS

TABLE 7A - 500 WATT TRANSIENT SUPPRESSOR DIE ELECTRICAL SPECIFICATIONS (NOTE 1)

INDUSTRY STANDARD PART NUMBERS (NOTE 2) 500 WATT SA SERIES	SUSSEX ORDER CODE REFER TO PAGE 7-10 FOR ORDER SPECIFIER	STANDOFF VOLTAGE (V _{SO}) Volts	MAX. REVERSE LEAKAGE (I _R) @ V _{SO} (NOTE 3) μA	REVERSE BREAKDOWN VOLTAGE (V _{BR}) @ I _T (NOTE 4)		TEST CURRENT (I _T) mA	MAX. CLAMPING VOLTAGE (V _{CL}) @ PEAK PULSE CURRENT (I _{PP}) (NOTE 5)		MAX. TEMP. COEFFICIENT OF V _{BR} (mV/°C)
				MIN. Volts	MAX. Volts		V _{CL} Volts	I _{PP} Amps	
				SA33	40.8-59-10		33	1	
SA33A	38.6-53.3-5	33	1	36.7	40.6	1	53.3	9.8	39.00
SA36	44.4-64.3-10	36	1	40.0	48.9	1	64.3	8.1	46.00
SA36A	42.1-58.1-4.9	36	1	40.0	44.2	1	58.1	9.0	41.00
SA40	49.3-71.4-10	40	1	44.4	54.3	1	71.4	7.3	51.00
SA40A	46.7-64.5-5	40	1	44.4	49.1	1	64.5	8.1	46.00
SA43	53.1-76.7-9.9	43	1	47.8	58.4	1	76.7	6.8	55.00
SA43A	50.3-69.4-4.8	43	1	47.9	52.8	1	69.4	7.5	50.00
SA45	55.5-80.3-9.9	45	1	50.0	61.1	1	80.3	6.5	58.00
SA45A	52.6-72.7-5	45	1	50.0	55.3	1	72.7	7.2	52.00
SA48	59.2-85.5-10	48	1	53.3	65.2	1	85.5	6.1	63.00
SA48A	56.1-77.4-4.9	48	1	53.3	58.9	1	77.4	6.7	56.00
SA51	63-91.1-10	51	1	56.7	69.3	1	91.1	5.7	66.00
SA51A	59.7-82.4-5	51	1	56.7	62.7	1	82.4	6.3	61.00
SA54	66.6-96.3-9.9	54	1	60.0	73.3	1	96.3	5.4	71.00
SA54A	63.1-87.1-4.9	54	1	60.0	66.3	1	87.1	6.0	65.00
SA58	71.5-103-9.9	58	1	64.4	78.7	1	103.0	5.0	78.00
SA58A	67.8-93.6-5	58	1	64.4	71.2	1	93.6	5.6	70.00
SA60	74.1-107-9.9	60	1	66.7	81.5	1	107.0	4.9	80.00
SA60A	70.2-96.8-4.9	60	1	66.7	73.7	1	96.8	5.4	71.00
SA64	79-114-10	64	1	71.1	86.9	1	114	4.6	86.00
SA64A	74.8-103-5	64	1	71.1	78.6	1	103	5.0	76.00
SA70	86.4-125-10	70	1	77.8	95.1	1	125	4.2	94.00
SA70A	81.9-113-5	70	1	77.8	86	1	113	4.6	85.00
SA75	92.6-134-10	75	1	83.3	102	1	134	3.9	101.00
SA75A	87.7-121-5	75	1	83.3	92.1	1	121	4.3	91.00
SA78	96.3-139-10	78	1	86.7	106	1	139	3.7	105.00
SA78A	91.2-126-4.9	78	1	86.7	95.8	1	126	4.1	95.00
SA85	104.7-151-9.8	85	1	94.4	115	1	151	3.4	114.00
SA85A	99.2-137-4.8	85	1	94.4	104	1	137	3.8	103.00
SA90	66-160-9.9	90	1	100.0	122	1	160	3.2	121.00
SA90A	105.5-146-5.2	90	1	100.0	111	1	146	3.5	110.00
SA100	123.5-179-10.1	100	1	111.0	136	1	179	2.9	135.00
SA100A	117-162-5.1	100	1	111.0	123	1	162	3.2	123.00
SA110	135.5-196-9.9	110	1	122.0	149	1	196	2.6	148.00
SA110A	128.5-177-5	110	1	122.0	135	1	177	2.9	133.00
SA120	148-214-10.1	120	1	133.0	163	1	214	2.4	162.00
SA120A	140-193-5	120	1	133.0	147	1	193	2.7	146.00
SA130	160-230-10	130	1	144.0	176	1	230	2.2	175.00
SA130A	151.5-209-4.9	130	1	144.0	159	1	209	2.5	158.00
SA150	185.5-268-9.9	150	1	167.0	204	1	268	1.9	203.00
SA150A	176-243-5.1	150	1	167.0	185	1	243	2.1	184.00
SA160	198-257-10.1	160	1	178.0	218	1	257	2.0	217.00
SA160A	187.5-259-5	160	1	178.0	197	1	259	2.0	196.00
SA170	210-304-10	170	1	189.0	231	1	304	1.7	230.00
SA170A	199-275-5	170	1	189.0	209	1	275	1.9	208.00

NOTES

- NOTE 1:** ♦ ELECTRICAL CHARACTERISTICS ARE AT A JUNCTION TEMPERATURE (T_J) OF 25°C
- NOTE 2:** ♦ INDUSTRY STANDARD PART NUMBERS REFER TO PACKAGED DEVICES. THE DIES INDICATED BY THESE NUMBERS, IF PROPERLY PACKAGED, WILL OPERATE WITH THE SAME PERFORMANCE
- NOTE 3:** ♦ FOR BIPOLAR DEVICES WITH A V_{BR} OF 10 VOLTS OR LESS, THE I_R LIMIT IS DOUBLED
- NOTE 4:** ♦ DUAL DIE V_{BR} IS MEASURED FROM TOP TO TOP OF DIE V_{BR} MEASURED FROM TOP TO BOTTOM WILL RESULT IN A LOWER V_{BR}
- NOTE 5:** ♦ SURGE CURRENT WAVEFORM SHOWN IN FIGURE 2A ON PAGE 7-10
♦ PEAK PULSE POWER DERATING SHOWN IN FIGURE 3A ON PAGE 7-10

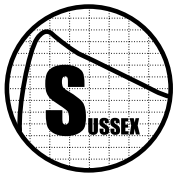

ORDERING SPECIFIER

6.8 - 9.6 - 6.5

ORDER CODE FROM
PREVIOUS PAGES

TABLE 8A - AVAILABLE DIE SIZES		
CODE	DIE TYPE	DIE SPECIFICATIONS REFER TO:
SZU2	500 WATT UNIPOLAR DIE	PAGE 7-1
SZZ2	500 WATT BIPOLAR DIE	PAGE 7-2
SZUFD2	500 WATT UNIPOLAR FLIP-DIE	PAGE 7-3
SZZD2	500 WATT BIPOLAR DUAL-DIE	PAGE 7-4

FIGURE 1A - TYPICAL JUNCTION CAPACITANCE

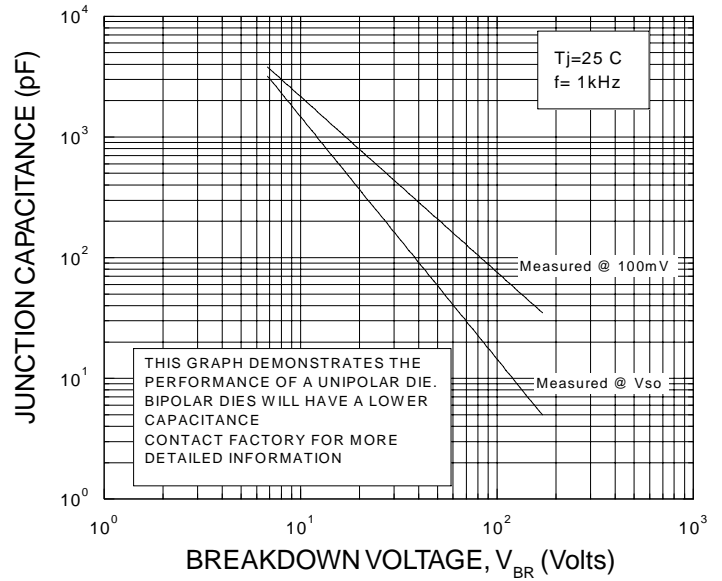

FIGURE 2A - PULSE WAVEFORM

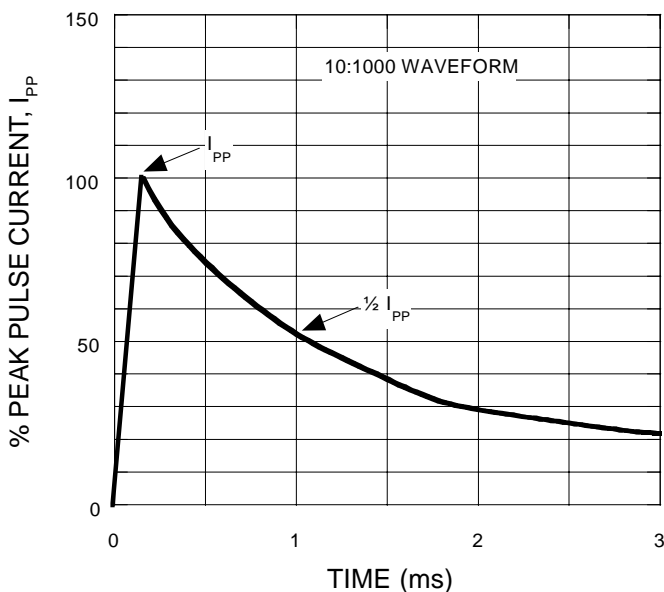
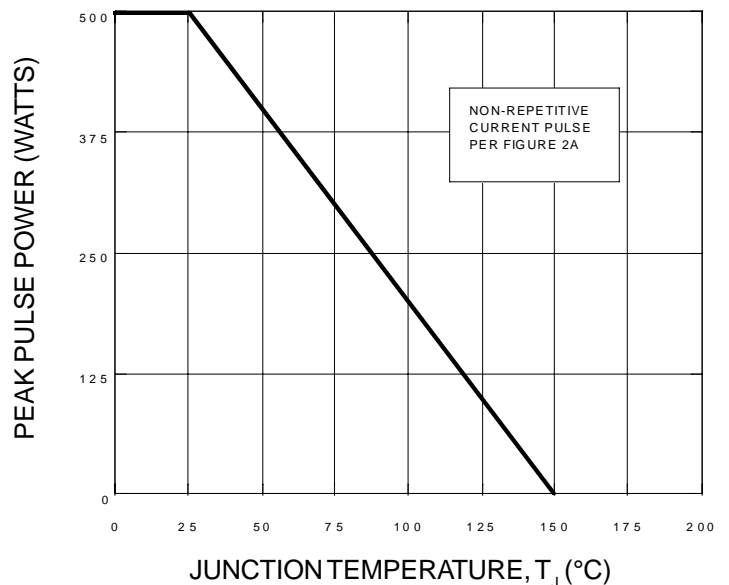
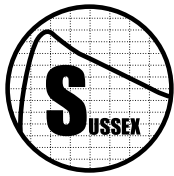

FIGURE 3A - PULSE DERATING CURVE





SUSSEX

SEMICONDUCTOR, INC.

12251 TOWNE LAKE DRIVE, FORT MYERS, FLORIDA, 33913 • TEL: (941) 768-6800 • FAX: (941) 768-6868

600 WATT TRANSIENT SUPPRESSOR DIE SPECIFICATIONS

TABLE 9A - 600 WATT TRANSIENT SUPPRESSOR DIE ELECTRICAL SPECIFICATIONS (NOTE 1)

INDUSTRY STANDARD PART NUMBERS 600 WATT P6KE SERIES	SUSSEX ORDER CODE REFER TO PAGE 7-13 FOR ORDER SPECIFIER	STANDOFF VOLTAGE (V _{SO}) Volts	MAX. REVERSE LEAKAGE (I _R)@ V _{SO} (NOTE 2) μA	REVERSE BREAKDOWN VOLTAGE (V _{BR}) @ I _T (NOTE 3)		TEST CURRENT (I _T) mA	MAX. CLAMPING VOLTAGE (V _{CL}) @ PEAK PULSE CURRENT (I _{PP}) (NOTE 4)		MAX. TEMP. COEFFICIENT OF V _{BR} (%/°C)
				MIN. Volts	MAX. Volts		V _{CL} Volts	I _{PP} Amps	
				P6KE6.8	6.8-10.8-10		5.50	1000	
P6KE6.8A	6.8-10.5-5	5.80	1000	6.45	7.14	10	10.5	60.0	0.057
P6KE7.5	7.5-11.7-10	6.05	500	6.75	8.25	10	11.7	53.0	0.061
P6KE7.5A	7.5-11.3-5	6.40	500	7.13	7.88	10	11.3	55.0	0.061
P6KE8.2	8.2-12.5-10	6.63	200	7.38	9.02	10	12.5	50.0	0.065
P6KE8.2A	8.2-12.1-5	7.02	200	7.79	8.61	10	12.1	52.0	0.065
P6KE9.1	9.1-13.8-10	7.37	50	8.19	10.00	1	13.8	45.0	0.068
P6KE9.1A	9.1-13.4-5	7.78	50	8.65	9.55	1	13.4	47.0	0.068
P6KE10	10-15.0-10	8.10	10	9.00	11.00	1	15.0	42.0	0.073
P6KE10A	10-14.5-5	8.55	10	9.50	10.50	1	14.5	43.0	0.073
P6KE11	11-16.2-10	8.92	5.0	9.90	12.10	1	16.2	38.0	0.075
P6KE11A	11-15.6-5	9.40	5.0	10.50	11.60	1	15.6	40.0	0.075
P6KE12	12-17.3-10	9.72	5.0	10.80	13.20	1	17.3	36.0	0.078
P6KE12A	12-16.7-5	10.20	5.0	11.40	12.60	1	16.7	37.0	0.078
P6KE13	13-19.0-10	10.50	5.0	11.70	14.30	1	19.0	33.0	0.061
P6KE13A	13-18.2-5	11.10	5.0	12.40	13.70	1	18.2	34.0	0.081
P6KE15	15-22.0-10	12.10	5.0	13.50	16.50	1	22.0	28.0	0.084
P6KE15A	15-21.2-5	12.80	5.0	14.30	15.80	1	21.2	29.0	0.084
P6KE16	16-23.5-10	12.90	5.0	14.40	17.60	1	23.5	26.0	0.086
P6KE16A	16-22.5-5	13.60	5.0	15.20	16.80	1	22.5	28.0	0.086
P6KE18	18-26.5-10	14.50	5.0	16.20	19.80	1	26.5	23.0	0.088
P6KE18A	18-25.2-5	15.30	5.0	17.10	18.90	1	25.2	25.0	0.088
P6KE20	20-29.1-10	16.20	5.0	18.00	22.00	1	29.1	21.0	0.090
P6KE20A	20-27.7-5	17.10	5.0	19.00	21.00	1	27.7	22.0	0.090
P6KE22	22-31.9-10	17.80	5.0	19.80	24.20	1	31.9	19.0	0.092
P6KE22A	22-30.6-5	18.80	5.0	20.90	23.10	1	30.6	20.0	0.092
P6KE24	24-34.7-10	19.40	5.0	21.60	26.40	1	34.7	18.0	0.091
P6KE24A	24-33.2-5	20.50	5.0	22.80	25.20	1	33.2	19.0	0.094
P6KE27	27-39.1-10	21.80	5.0	24.30	29.70	1	39.0	16.0	0.096
P6KE27A	27-37.5-5	23.10	5.0	25.70	28.40	1	37.5	16.8	0.096
P6KE30	30-43.5-10	24.30	5.0	27.00	33.00	1	43.5	14.0	0.097
P6KE30A	30-41.4-5	25.60	5.0	28.50	31.50	1	41.4	15.0	0.097
P6KE33	33-47.7-10	26.80	5.0	29.70	36.30	1	47.7	13.0	0.098
P6KE33A	33-45.7-5	28.20	5.0	31.40	34.70	1	45.7	13.8	0.098
P6KE36	36-52.0-10	29.10	5.0	32.40	39.60	1	52.0	12.0	0.099
P6KE36A	36-49.9-5	30.80	5.0	34.20	37.80	1	49.9	12.6	0.099
P6KE39	39-56.4-10	31.60	5.0	35.10	42.90	1	56.4	11.1	0.100
P6KE39A	39-53.9-5	33.30	5.0	37.10	41.00	1	53.9	11.6	0.100
P6KE43	43-61.9-10	34.80	5.0	38.70	47.30	1	61.9	10.0	0.101
P6KE43A	43-59.3-5	36.80	5.0	40.90	45.20	1	59.3	10.6	0.101
P6KE47	47-67.8-10	38.10	5.0	42.30	51.70	1	67.8	9.2	0.101
P6KE47A	47-64.8-5	40.20	5.0	44.70	49.40	1	64.8	9.7	0.101
P6KE51	51-70.1-10	41.30	5.0	45.90	56.10	1	73.5	8.5	0.102

THIS TABLE CONTINUES

NOTES

- NOTE 1:** ♦ ELECTRICAL CHARACTERISTICS ARE AT A JUNCTION TEMPERATURE (T_J) OF 25°C
- NOTE 2:** ♦ INDUSTRY STANDARD PART NUMBERS REFER TO PACKAGED DEVICES. THE DIES INDICATED BY THESE NUMBERS, IF PROPERLY PACKAGED, WILL OPERATE WITH THE SAME PERFORMANCE
- NOTE 3:** ♦ FOR BIPOLAR DEVICES WITH A V_{BR} OF 10 VOLTS OR LESS, THE I_R LIMIT IS DOUBLED
- NOTE 4:** ♦ DUAL DIE V_{BR} IS MEASURED FROM TOP TO TOP OF DIE V_{BR} MEASURED FROM TOP TO BOTTOM WILL RESULT IN A LOWER V_{BR}
- NOTE 5:** ♦ SURGE CURRENT WAVEFORM SHOWN IN FIGURE 2A ON PAGE 7-13
♦ PEAK PULSE POWER DERATING SHOWN IN FIGURE 3A ON PAGE 7-13

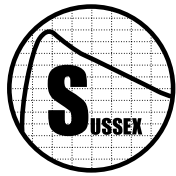

SUSSEX

SEMICONDUCTOR, INC.

12251 TOWNE LAKE DRIVE, FORT MYERS, FLORIDA, 33913 • TEL: (941) 768-6800 • FAX: (941) 768-6868

600 WATT TRANSIENT SUPPRESSOR DIE SPECIFICATIONS

TABLE 9A - 600 WATT TRANSIENT SUPPRESSOR DIE ELECTRICAL SPECIFICATIONS (NOTE 1)

INDUSTRY STANDARD PART NUMBERS 600 WATT P6KE SERIES	SUSSEX ORDER CODE REFER TO PAGE 7-13 FOR ORDER SPECIFIER	STANDOFF VOLTAGE (V_{SO}) Volts	MAX. REVERSE LEAKAGE (I_R) @ V_{SO} (NOTE 2) μA	REVERSE BREAKDOWN VOLTAGE (V_{BR}) @ I_T (NOTE 3)		TEST CURRENT (I_T) mA	MAX. CLAMPING VOLTAGE (V_{CL}) @ PEAK PULSE CURRENT (I_{PP}) (NOTE 4)		MAX. TEMP. COEFFICIENT OF V_{BR} (%/°C)
				MIN. Volts	MAX. Volts		V_{CL} Volts	I_{PP} Amps	
				P6KE51A	51-70.1-5		43.60	5.0	
P6KE56	56-80.5-10	45.40	5.0	50.40	61.60	1	80.5	7.8	0.103
P6KE56A	56-77.0-5	47.80	5.0	53.20	58.80	1	77.0	8.1	0.103
P6KE62	62-89.0-10	50.20	5.0	55.80	68.20	1	89.0	7.0	0.104
P6KE62A	62-85.0-5	53.00	5.0	58.90	65.10	1	85.0	7.4	0.104
P6KE68	68-96.0-10	55.10	5.0	61.20	74.80	1	96.0	6.4	0.104
P6KE68A	68-92.0-5	58.10	5.0	64.60	71.40	1	92.0	6.8	0.104
P6KE75	75-108.0-10	60.70	5.0	67.50	82.50	1	108.0	5.8	0.105
P6KE75A	75-103.0-5	64.10	5.0	71.30	78.80	1	103.0	6.1	0.105
P6KE82	82-118.0-10	66.40	5.0	73.80	90.20	1	118.0	5.3	0.105
P6KE82A	82-113.0-5	70.10	5.0	77.90	86.10	1	113.0	5.5	0.105
P6KE91	91-131.0-10	73.70	5.0	81.90	100.00	1	131.0	4.8	0.106
P6KE91A	91-125.0-5	77.80	5.0	86.50	95.50	1	125.0	5.0	0.106
P6KE100	100-144.0-10	81.00	5.0	90.00	110.00	1	144.0	4.3	0.106
P6KE100A	100-137.0-5	85.50	5.0	95.00	105.00	1	137.0	4.5	0.106
P6KE110	110-158.0-10	89.20	5.0	99.00	121.00	1	158.0	3.9	0.107
P6KE110A	110-152.0-5	94.00	5.0	105.00	116.00	1	152.0	4.1	0.107
P6KE120	120-173.0-10	97.20	5.0	108.00	132.00	1	173.0	3.6	0.107
P6KE120A	120-165.0-5	102.00	5.0	114.00	126.00	1	165.0	3.8	0.107
P6KE130	130-187.0-10	105.00	5.0	117.00	143.00	1	187.0	3.3	0.107
P6KE130A	130-179.0-5	111.00	5.0	124.00	137.00	1	179.0	3.5	0.107
P6KE150	150-215.0-10	121.00	5.0	135.00	165.00	1	215.0	2.9	0.108
P6KE150A	150-207.0-5	128.00	5.0	143.00	158.00	1	207.0	3.0	0.108
P6KE160	160-230.0-10	130.00	5.0	144.00	176.00	1	230.0	2.7	0.108
P6KE160A	160-219.0-5	136.00	5.0	152.00	168.00	1	219.0	2.8	0.108
P6KE170	170-244.0-10	138.00	5.0	153.00	187.00	1	244.0	2.5	0.108
P6KE170A	170-234.0-5	145.00	5.0	162.00	179.00	1	234.0	2.6	0.108
P6KE180	180-256.0-10	146.00	5.0	162.00	198.00	1	256.0	2.4	0.108
P6KE180A	180-246.0-5	154.00	5.0	171.00	189.00	1	246.0	2.5	0.108
P6KE200	200-287.0-10	162.00	5.0	180.00	220.00	1	287.0	2.1	0.108
P6KE200A	200-274.0-5	171.00	5.0	190.00	210.00	1	274.0	2.2	0.108
P6KE220	220-344.0-10	175.00	5.0	198.00	242.00	1	344.0	1.8	0.108
P6KE220A	220-328.0-5	185.00	5.0	209.00	231.00	1	328.0	1.9	0.108
P6KE250	250-360.0-10	202.00	5.0	225.00	275.00	1	360.0	1.7	0.110
P6KE250A	250-344.0-5	214.00	5.0	237.00	263.00	1	344.0	1.8	0.110
P6KE300	300-430.0-10	243.00	5.0	270.00	330.00	1	430.0	1.4	0.110
P6KE300A	300-414.0-5	256.00	5.0	285.00	315.00	1	414.0	1.5	0.110
P6KE350	350-504.0-10	284.00	5.0	315.00	385.00	1	504.0	1.2	0.110
P6KE350A	350-482.0-5	300.00	5.0	332.00	368.00	1	482.0	1.3	0.110
P6KE400	400-574.0-10	324.00	5.0	360.00	440.00	1	571.0	1.9	0.110
P6KE400A	400-548.0-5	342.00	5.0	380.00	420.00	1	548.0	1.1	0.110
P6KE440	440-598.0-10	356.00	5.0	396.00	484.00	1	598.0	0.99	0.110
P6KE440A	440-590.0-5	376.00	5.0	418.00	462.00	1	590.0	1.04	0.110

NOTES

- NOTE 1:** ♦ ELECTRICAL CHARACTERISTICS ARE AT A JUNCTION TEMPERATURE (T_J) OF 25°C
- NOTE 2:** ♦ INDUSTRY STANDARD PART NUMBERS REFER TO PACKAGED DEVICES. THE DIES INDICATED BY THESE NUMBERS, IF PROPERLY PACKAGED, WILL OPERATE WITH THE SAME PERFORMANCE
- NOTE 3:** ♦ FOR BIPOLAR DEVICES WITH A V_{BR} OF 10 VOLTS OR LESS, THE I_R LIMIT IS DOUBLED
- NOTE 4:** ♦ DUAL DIE V_{BR} IS MEASURED FROM TOP TO TOP OF DIE V_{BR} MEASURED FROM TOP TO BOTTOM WILL RESULT IN A LOWER V_{BR}
- NOTE 5:** ♦ SURGE CURRENT WAVEFORM SHOWN IN FIGURE 2A ON PAGE 7-13
♦ PEAK PULSE POWER DERATING SHOWN IN FIGURE 3A ON PAGE 7-13

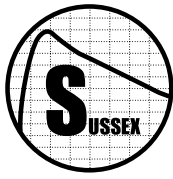

SUSSEX

SEMICONDUCTOR, INC.

12251 TOWN LAKE DRIVE, FORT MYERS, FLORIDA, 33913 • TEL: (941) 768-6800 • FAX: (941) 768-6868

**600 WATT DIE
SPECIFICATIONS CONTINUED**

ORDERING SPECIFIER

6.8 - 10.8 - 10

ORDER CODE FROM PREVIOUS PAGES

TABLE 10A - AVAILABLE DIE SIZES

CODE	DIE TYPE	DIE SPECIFICATIONS REFER TO:
SZU3	600 WATT UNIPOLAR DIE	PAGE 7-1
SZZ3	600 WATT BIPOLAR DIE	PAGE 7-2
SZUFD3	600 WATT UNIPOLAR FLIP-DIE	PAGE 7-3
SZZD3	600 WATT BIPOLAR DUAL-DIE	PAGE 7-4

FIGURE 1A - TYPICAL JUNCTION CAPACITANCE

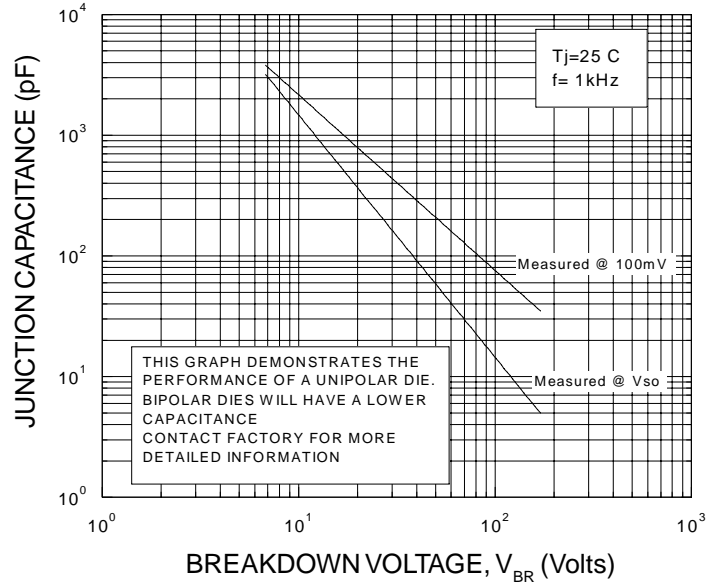

FIGURE 2A - PULSE WAVEFORM

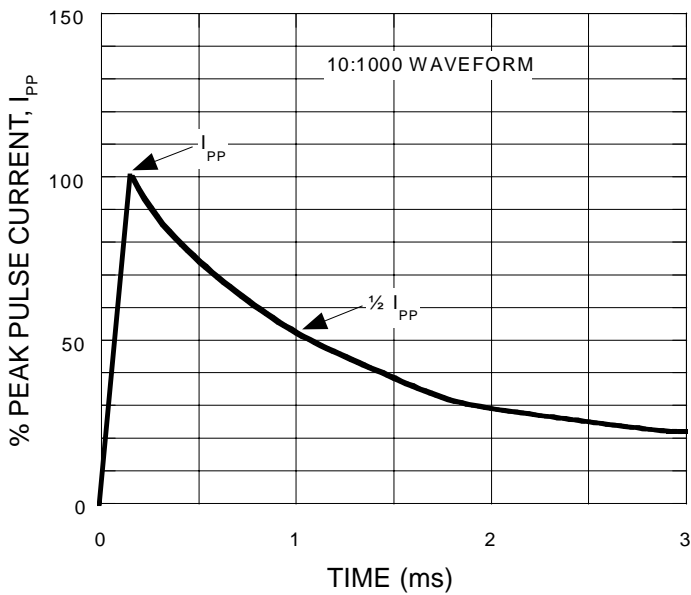
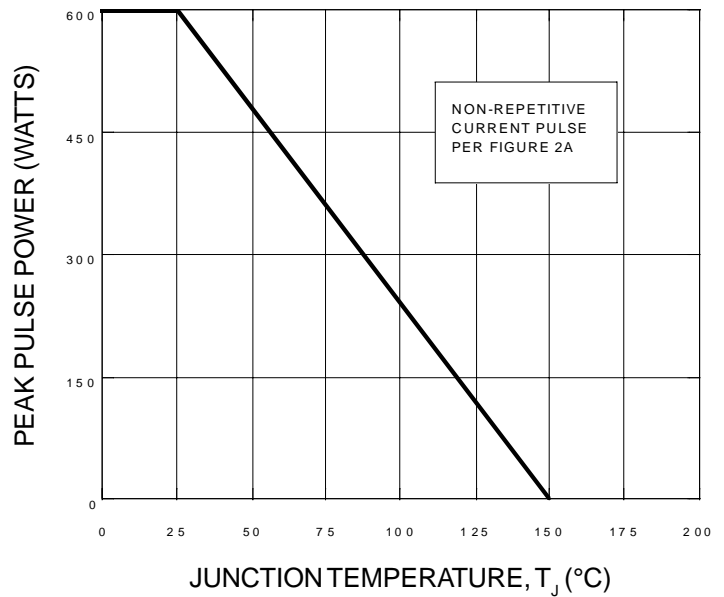

FIGURE 3A - PULSE DERATING CURVE





SUSSEX

SEMICONDUCTOR, INC.

12251 TOWNE LAKE DRIVE, FORT MYERS, FLORIDA, 33913 • TEL: (941) 768-6800 • FAX: (941) 768-6868

1500 WATT TRANSIENT SUPPRESSOR DIE SPECIFICATIONS

TABLE 11A - 1500 WATT TRANSIENT SUPPRESSOR DIE ELECTRICAL SPECIFICATIONS (NOTE 1)

JEDEC PART NUMBERS (NOTE 2)	INDUSTRY STANDARD PART NUMBERS 1500 WATT 1.5KE SERIES	SUSSEX ORDER CODE REFER TO PAGE 7-16 FOR ORDER SPECIFIER	STANDOFF VOLTAGE (V _{SO}) Volts	MAX. REVERSE LEAKAGE (I _R) @ V _{SO} (NOTE 3) µA	REVERSE BREAKDOWN VOLTAGE (V _{BR}) @ I _T (NOTE 4)		TEST CURRENT (I _T) mA	MAX. CLAMPING VOLTAGE (V _{CL}) @ PEAK PULSE CURRENT (I _{PP}) (NOTE 5)		MAX. TEMP. COEFFICIENT OF V _{BR} (%/°C)
					MIN. Volts	MAX. Volts		V _{CL} Volts	I _{PP} Amps	
					1N6267	1.5KE6.8		6.8-10.8-10	5.50	
1N6267A	1.5KE6.8A	6.8-10.5-5	5.80	1000	6.45	7.14	10	10.5	150.0	0.057
1N6268	1.5KE7.5	7.5-11.7-10	6.05	500	6.75	8.25	10	11.7	134.0	0.061
1N6268A	1.5KE7.5A	7.5-11.3-5	6.40	500	7.13	7.88	10	11.3	139.0	0.061
1N6269	1.5KE8.2	8.2-12.5-10	6.63	200	7.38	9.02	10	12.5	126.0	0.065
1N6269A	1.5KE8.2A	8.2-12.1-5	7.02	200	7.79	8.61	10	12.1	130.0	0.065
1N6270	1.5KE9.1	9.1-13.8-10	7.37	50	8.19	10.00	1	13.8	114.0	0.068
1N6270A	1.5KE9.1A	9.1-13.4-5	7.78	50	8.65	9.55	1	13.4	117.0	0.068
1N6271	1.5KE10	10-15.0-10	8.10	10	9.00	11.00	1	15.0	105.0	0.073
1N6271A	1.5KE10A	10-14.5-5	8.55	10	9.50	10.50	1	14.5	108.0	0.073
1N6272	1.5KE11	11-16.2-10	8.92	5.0	9.90	12.10	1	16.2	97.0	0.075
1N6272A	1.5KE11A	11-15.6-5	9.40	5.0	10.50	11.60	1	15.6	100.0	0.075
1N6273	1.5KE12	12-17.3-10	9.72	5.0	10.80	13.20	1	17.3	91.0	0.078
1N6273A	1.5KE12A	12-16.7-5	10.20	5.0	11.40	12.60	1	16.7	94.0	0.078
1N6274	1.5KE13	13-19.0-10	10.50	5.0	11.70	14.30	1	19.0	82.0	0.061
1N6274A	1.5KE13A	13-18.2-5	11.10	5.0	12.40	13.70	1	18.2	86.0	0.081
1N6275	1.5KE15	15-22.0-10	12.10	5.0	13.50	16.50	1	22.0	71.0	0.084
1N6275A	1.5KE15A	15-21.2-5	12.80	5.0	14.30	15.80	1	21.2	74.0	0.084
1N6276	1.5KE16	16-23.5-10	12.90	5.0	14.40	17.60	1	23.5	67.0	0.086
1N6276A	1.5KE16A	16-22.5-5	13.60	5.0	15.20	16.80	1	22.5	70.0	0.086
1N6277	1.5KE18	18-26.5-10	14.50	5.0	16.20	19.80	1	26.5	59.0	0.088
1N6277A	1.5KE18A	18-25.2-5	15.30	5.0	17.10	18.90	1	25.2	60.0	0.088
1N6278	1.5KE20	20-29.1-10	16.20	5.0	18.00	22.00	1	29.1	54.0	0.090
1N6278A	1.5KE20A	20-27.7-5	17.10	5.0	19.00	21.00	1	27.7	56.0	0.090
1N6279	1.5KE22	22-31.9-10	17.80	5.0	19.80	24.20	1	31.9	49.0	0.092
1N6279A	1.5KE22A	22-30.6-5	18.80	5.0	20.90	23.10	1	30.6	51.0	0.092
1N6280	1.5KE24	24-34.7-10	19.40	5.0	21.60	26.40	1	34.7	45.0	0.091
1N6280A	1.5KE24A	24-33.2-5	20.50	5.0	22.80	25.20	1	33.2	47.0	0.094
1N6281	1.5KE27	27-39.1-10	21.80	5.0	24.30	29.70	1	39.1	40.0	0.096
1N6281A	1.5KE27A	27-37.5-5	23.10	5.0	25.70	28.40	1	37.5	42.0	0.096
1N6282	1.5KE30	30-43.5-10	24.30	5.0	27.00	33.00	1	43.5	36.0	0.097
1N6282A	1.5KE30A	30-41.4-5	25.60	5.0	28.50	31.50	1	41.4	38.0	0.097
1N6283	1.5KE33	33-47.7-10	26.80	5.0	29.70	36.30	1	47.7	33.0	0.098
1N6283A	1.5KE33A	33-45.7-5	28.20	5.0	31.40	34.70	1	45.7	34.0	0.098
1N6284	1.5KE36	36-52.0-10	29.10	5.0	32.40	39.60	1	52.0	30.0	0.099
1N6284A	1.5KE36A	36-49.9-5	30.80	5.0	34.20	37.80	1	49.9	31.0	0.099
1N6285	1.5KE39	39-56.4-10	31.60	5.0	35.10	42.90	1	56.4	27.0	0.100
1N6285A	1.5KE39A	39-53.9-5	33.30	5.0	37.10	41.00	1	53.9	29.0	0.100
1N6286	1.5KE43	43-61.9-10	34.80	5.0	38.70	47.30	1	61.9	25.0	0.101
1N6286A	1.5KE43A	43-59.3-5	36.80	5.0	40.90	45.20	1	59.3	26.0	0.101
1N6287	1.5KE47	47-67.8-10	36.10	5.0	42.30	51.70	1	67.8	23.0	0.101
1N6287A	1.5KE47A	47-64.8-5	40.20	5.0	44.70	49.40	1	64.8	24.0	0.101
1N6288	1.5KE51	51-70.1-10	41.30	5.0	45.90	56.10	1	73.5	21.0	0.102

THIS TABLE CONTINUES

NOTES

- NOTE 1:** ♦ ELECTRICAL CHARACTERISTICS ARE AT A JUNCTION TEMPERATURE (T_J) OF 25°C
- NOTE 2:** ♦ INDUSTRY STANDARD PART NUMBERS REFER TO PACKAGED DEVICES. THE DIES INDICATED BY THESE NUMBERS, IF PROPERLY PACKAGED, WILL OPERATE WITH THE SAME PERFORMANCE
- NOTE 3:** ♦ FOR BIPOLAR DEVICES WITH A V_{BR} OF 10 VOLTS OR LESS, THE I_R LIMIT IS DOUBLED
- NOTE 4:** ♦ DUAL DIE V_{BR} IS MEASURED FROM TOP TO TOP OF DIE V_{BR} MEASURED FROM TOP TO BOTTOM WILL RESULT IN A LOWER V_{BR}
- NOTE 5:** ♦ SURGE CURRENT WAVEFORM SHOWN IN FIGURE 2A ON PAGE 7-16
♦ PEAK PULSE POWER DERATING SHOWN IN FIGURE 3A ON PAGE 7-16

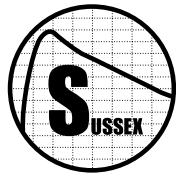

SUSSEX

SEMICONDUCTOR, INC.

12251 TOWNE LAKE DRIVE, FORT MYERS, FLORIDA, 33913 • TEL: (941) 768-6800 • FAX: (941) 768-6868

1500 WATT TRANSIENT SUPPRESSOR DIE SPECIFICATIONS

TABLE 11A - 1500 WATT TRANSIENT SUPPRESSOR DIE ELECTRICAL SPECIFICATIONS (NOTE 1)

JEDEC PART NUMBERS (NOTE 2)	INDUSTRY STANDARD PART NUMBERS 1500 WATT 1.5KE SERIES	SUSSEX ORDER CODE REFER TO PAGE 7-16 FOR ORDER SPECIFIER	STANDOFF VOLTAGE (V _{SO}) Volts	MAX. REVERSE LEAKAGE (I _R)@ V _{SO} (NOTE 3) µA	REVERSE BREAKDOWN VOLTAGE (V _{BR}) @ I _T (NOTE 4)		TEST CURRENT (I _T) mA	MAX. CLAMPING VOLTAGE (V _{CL}) @ PEAK PULSE CURRENT (I _{PP}) (NOTE 5)		MAX. TEMP. COEFFICIENT OF V _{BR} (%/°C)
					MIN. Volts	MAX. Volts		V _{CL} Volts	I _{PP} Amps	
					1N6288A	1.5KE51A		51-70.1-5	43.60	
1N6289	1.5KE56	56-80.5-10	45.60	5.0	50.40	61.80	1	80.5	19.0	0.103
1N6289A	1.5KE56A	56-77.0-5	47.80	5.0	53.20	58.80	1	77.0	20.0	0.103
1N6290	1.5KE62	62-89.0-10	50.20	5.0	55.80	68.20	1	89.0	17.0	0.104
1N6290A	1.5KE62A	62-85.0-5	53.00	5.0	58.90	65.10	1	85.0	18.0	0.104
1N6291	1.5KE68	68-96.0-10	55.10	5.0	61.20	74.80	1	96.0	16.0	0.104
1N6291A	1.5KE68A	68-92.0-5	58.10	5.0	64.60	71.40	1	92.0	17.0	0.104
1N6292	1.5KE75	75-108.0-10	60.70	5.0	67.50	82.50	1	108.0	14.0	0.105
1N6292A	1.5KE75A	75-103.0-5	64.10	5.0	71.30	78.80	1	103.0	15.0	0.105
1N6293	1.5KE82	82-118.0-10	66.40	5.0	73.80	90.20	1	118.0	13.0	0.105
1N6293A	1.5KE82A	82-113.0-5	70.10	5.0	77.90	86.10	1	113.0	13.9	0.105
1N6294	1.5KE91	91-131.0-10	73.70	5.0	81.90	100.00	1	131.0	12.0	0.106
1N6294A	1.5KE91A	91-125.0-5	77.80	5.0	86.50	95.50	1	125.0	12.6	0.106
1N6295	1.5KE100	100-144.0-10	81.00	5.0	90.00	110.00	1	144.0	10.9	0.106
1N6295A	1.5KE100A	100-137.0-5	85.50	5.0	95.00	105.00	1	137.0	11.4	0.106
1N6296	1.5KE110	110-158.0-10	89.20	5.0	99.00	121.00	1	158.0	9.9	0.107
1N6296A	1.5KE110A	110-152.0-5	94.00	5.0	106.00	116.00	1	152.0	10.3	0.107
1N6297	1.5KE120	120-173.0-10	97.20	5.0	108.00	132.00	1	173.0	9.1	0.107
1N6297A	1.5KE120A	120-165.0-5	102.00	5.0	114.00	126.00	1	165.0	9.5	0.107
1N6298	1.5KE130	130-187.0-10	106.00	5.0	117.00	143.00	1	187.0	8.4	0.107
1N6298A	1.5KE130A	130-179.0-5	111.00	5.0	124.00	137.00	1	179.0	8.7	0.107
1N6299	1.5KE150	150-215.0-10	121.00	5.0	136.00	165.00	1	215.0	7.3	0.108
1N6299A	1.5KE150A	150-207.0-5	128.00	5.0	143.00	158.00	1	207.0	7.6	0.108
1N6300	1.5KE160	160-230.0-10	130.00	5.0	144.00	176.00	1	230.0	6.8	0.108
1N6300A	1.5KE160A	160-219.0-5	136.00	5.0	152.00	168.00	1	219.0	7.1	0.108
1N6301	1.5KE170	170-244.0-10	138.00	5.0	153.00	187.00	1	244.0	6.4	0.108
1N6301A	1.5KE170A	170-234.0-5	145.00	5.0	162.00	179.00	1	234.0	6.7	0.108
1N6302	1.5KE180	180-256.0-10	146.00	5.0	162.00	198.00	1	256.0	6.1	0.108
1N6302A	1.5KE180A	180-246.0-5	154.00	5.0	171.00	189.00	1	246.0	6.4	0.108
1N6303	1.5KE200	200-287.0-10	162.00	5.0	180.00	220.00	1	287.0	5.4	0.108
1N6303A	1.5KE200A	200-274.0-5	171.00	5.0	190.00	210.00	1	274.0	5.7	0.108
N/A	1.5KE220	220-344.0-10	175.00	5.0	196.00	242.00	1	344.0	4.5	0.108
N/A	1.5KE220A	220-328.0-5	185.00	5.0	209.00	231.00	1	328.0	4.8	0.108
N/A	1.5KE250	250-360.0-10	202.00	5.0	225.00	275.00	1	360.0	4.3	0.110
N/A	1.5KE250A	250-344.0-5	214.00	5.0	237.00	263.00	1	344.0	4.5	0.110
N/A	1.5KE300	300-430.0-10	243.00	5.0	270.00	330.00	1	430.0	3.6	0.110
N/A	1.5KE300A	300-414.0-5	256.00	5.0	285.00	315.00	1	414.0	3.8	0.110
N/A	1.5KE350	350-504.0-10	284.00	5.0	315.00	385.00	1	504.0	3.1	0.110
N/A	1.5KE350A	350-482.0-5	300.00	5.0	333.00	368.00	1	482.0	3.2	0.110
N/A	1.5KE400	400-574.0-10	324.00	5.0	360.00	440.00	1	574.0	2.7	0.110
N/A	1.5KE400A	400-548.0-5	342.00	5.0	380.00	420.00	1	548.0	2.8	0.110
N/A	1.5KE440	440-598.0-10	356.00	5.0	396.00	484.00	1	598.0	2.4	0.110
N/A	1.5KE440A	440-590.0-5	376.00	5.0	418.00	462.00	1	590.0	2.6	0.110

NOTES

- NOTE 1:** ♦ ELECTRICAL CHARACTERISTICS ARE AT A JUNCTION TEMPERATURE (T_J) OF 25°C
- NOTE 2:** ♦ INDUSTRY STANDARD PART NUMBERS REFER TO PACKAGED DEVICES. THE DIES INDICATED BY THESE NUMBERS, IF PROPERLY PACKAGED, WILL OPERATE WITH THE SAME PERFORMANCE
- NOTE 3:** ♦ FOR BIPOLAR DEVICES WITH A V_{BR} OF 10 VOLTS OR LESS, THE I_R LIMIT IS DOUBLED
- NOTE 4:** ♦ DUAL DIE V_{BR} IS MEASURED FROM TOP TO TOP OF DIE V_{BR} MEASURED FROM TOP TO BOTTOM WILL RESULT IN A LOWER V_{BR}
- NOTE 5:** ♦ SURGE CURRENT WAVEFORM SHOWN IN FIGURE 2A ON PAGE 7-16
♦ PEAK PULSE POWER DERATING SHOWN IN FIGURE 3A ON PAGE 7-16



SUSSEX

SEMICONDUCTOR, INC.

12251 TOWNE LAKE DRIVE, FORT MYERS, FLORIDA, 33913 • TEL: (941) 768-6800 • FAX: (941) 768-6868

1500 WATT DIE SPECIFICATIONS CONTINUED

ORDERING SPECIFIER

6.8 - 10.8 - 10

ORDER CODE FROM PREVIOUS PAGES

TABLE 12A - AVAILABLE DIE SIZES

CODE	DIE TYPE	DIE SPECIFICATIONS REFER TO:
SZU16	1500 WATT UNIPOLAR DIE	PAGE 7-1
SZZ16	1500 WATT BIPOLAR DIE	PAGE 7-2
SZUFD16	1500 WATT UNIPOLAR FLIP-DIE	PAGE 7-3
SZZD16	1500 WATT BIPOLAR DUAL-DIE	PAGE 7-4

FIGURE 1A - TYPICAL JUNCTION CAPACITANCE

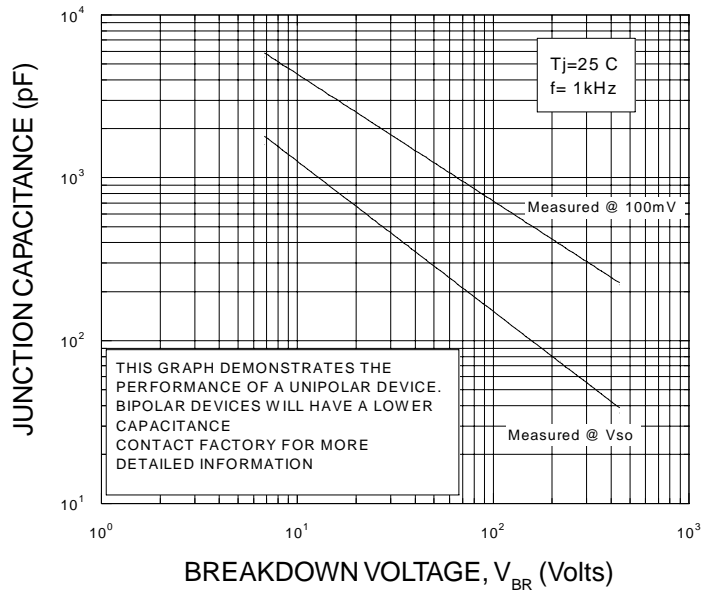

FIGURE 2A - PULSE WAVEFORM

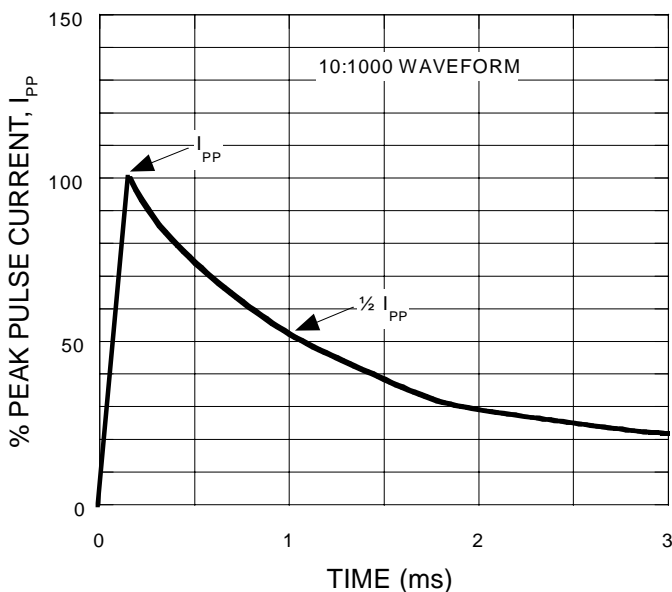

FIGURE 3A - PULSE DERATING CURVE

