

1N4728A THRU 1N4764A

List

List..... 1

Package outline..... 2

Features..... 2

Mechanical data..... 2

Maximum ratings2

Electrical characteristics.....3

Rating and characteristic curves..... 4

Pinning information.....5

Taping & bulk specifications for AXIAL devices..... 5

Suggested thermal profiles for soldering processes..... 6

High reliability test capabilities.....7

Searchdatasheet.com

1N4728A THRU 1N4764A

1000mW Axial Lead Zener
Diodes - 3.3V-100V

Features

- Silicon epitaxial planar chip structure.
- Leaded glass hermetically sealed package.
- Wide zener reverse voltage range 3.3V to 100V.
- Other tolerances are available upon request.
- Lead-free parts meet environmental standards of MIL-STD-19500 /228

Mechanical data

- Case : Glass, DO-41G
- Terminals :Plated terminals, solderable per MIL-STD-750, Method 2026
- Polarity : Indicated by cathode band
- Mounting Position : Any
- Weight : Approximated 0.31 gram

Package outline

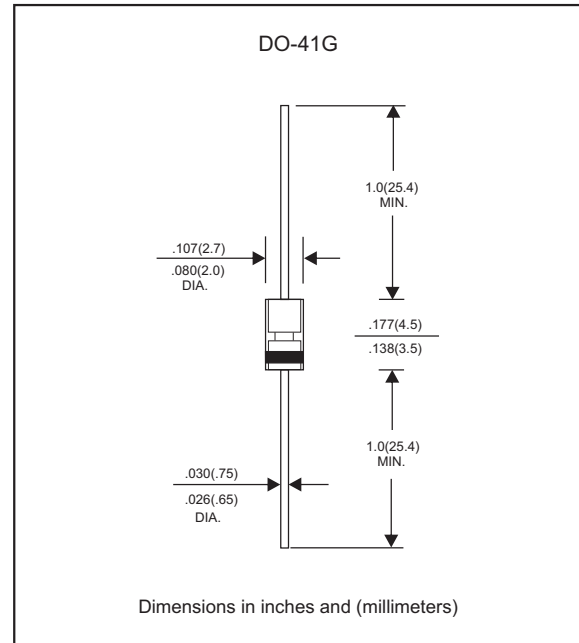

MAXIMUM RATINGS (at $T_A=25^\circ\text{C}$ unless otherwise noted)

PARAMETER	CONDITIONS	Symbol	MIN.	TYP.	MAX.	UNIT
Forward voltage	$I_F = 200 \text{ mA}$	V_F			1.20	V
Power Dissipation	$T_{amb} \leq 50^\circ\text{C}$	P_D			1000	mW
Operating temperature		T_J	-55		+150	$^\circ\text{C}$
Storage temperature		T_{STG}	-65		+175	$^\circ\text{C}$

1N4728A THRU 1N4764A

Electrical characteristics (at $T_A=25^\circ\text{C}$ unless otherwise noted)

Part No.	Marking code	Zener voltage			Test current	Zener impedance			Leakage current		Surge current
		$V_Z @ I_{ZT}(\text{Volts})$				I_{ZT}	$Z_{ZT} @ I_{ZT}$	$Z_{ZK} @ I_{ZK}$	I_{ZK}	I_R	
		Min.	Nom.	Max.	mA	(Ω)Max	(Ω)Max	mA	(μA)Max	Volts	mA
1N4728A	1N4728A	3.140	3.3	3.470	76	10	400	1.00	100	1.0	1380
1N4729A	1N4729A	3.420	3.6	3.780	69	10	400	1.00	100	1.0	1260
1N4730A	1N4730A	3.710	3.9	4.100	64	9	400	1.00	50	1.0	1190
1N4731A	1N4731A	4.090	4.3	4.520	58	9	400	1.00	10	1.0	1070
1N4732A	1N4732A	4.470	4.7	4.940	53	8	500	1.00	10	1.0	970
1N4733A	1N4733A	4.850	5.1	5.360	49	7	550	1.00	10	1.0	890
1N4734A	1N4734A	5.320	5.6	5.880	45	5	600	1.00	10	2.0	810
1N4735A	1N4735A	5.890	6.2	6.510	41	2	700	1.00	10	3.0	730
1N4736A	1N4736A	6.460	6.8	7.140	37	3.5	700	1.00	10	4.0	660
1N4737A	1N4737A	7.130	7.5	7.880	34	4.0	700	0.50	10	5.0	605
1N4738A	1N4738A	7.790	8.2	8.610	31	4.5	700	0.50	10	6.0	550
1N4739A	1N4739A	8.645	9.1	9.560	28	5	700	0.50	10	7.0	500
1N4740A	1N4740A	9.50	10	10.5	25	7	700	0.25	10	7.6	454
1N4741A	1N4741A	10.45	11	11.55	23	8	700	0.25	5	8.4	414
1N4742A	1N4742A	11.40	12	12.60	21	9	700	0.25	5	9.1	380
1N4743A	1N4743A	12.35	13	13.65	19	10	700	0.25	5	9.9	344
1N4744A	1N4744A	14.25	15	15.75	17	14	700	0.25	5	11.4	304
1N4745A	1N4745A	15.20	16	16.80	15.5	16	700	0.25	5	12.2	285
1N4746A	1N4746A	17.10	18	18.90	14	20	750	0.25	5	13.7	250
1N4747A	1N4747A	19.00	20	21.00	12.5	22	750	0.25	5	15.2	225
1N4748A	1N4748A	20.90	22	23.10	11.5	23	750	0.25	5	16.7	205
1N4749A	1N4749A	22.80	24	25.20	10.5	25	750	0.25	5	18.2	190
1N4750A	1N4750A	25.65	27	28.35	9.5	35	750	0.25	5	20.6	170
1N4751A	1N4751A	28.50	30	31.50	8.5	40	1000	0.25	5	22.8	150
1N4752A	1N4752A	31.35	33	34.65	7.5	45	1000	0.25	5	25.4	135
1N4753A	1N4753A	34.20	36	37.80	7.0	50	1000	0.25	5	27.4	125
1N4754A	1N4754A	37.05	39	40.95	6.5	60	1000	0.25	5	29.7	115
1N4755A	1N4755A	40.85	43	45.15	6.0	70	1500	0.25	5	32.7	105
1N4756A	1N4756A	44.65	47	49.35	5.5	80	1500	0.25	5	35.8	97
1N4757A	1N4757A	48.45	51	53.55	5.0	95	1500	0.25	5	38.8	89
1N4758A	1N4758A	53.20	56	58.80	4.5	110	2000	0.25	5	42.6	81
1N4759A	1N4759A	58.90	62	65.10	4.0	125	2000	0.25	5	47.1	73
1N4760A	1N4760A	64.60	68	71.40	3.7	150	2000	0.25	5	51.7	67
1N4761A	1N4761A	71.25	75	78.75	3.3	175	2000	0.25	5	56.0	60
1N4762A	1N4762A	77.90	82	86.10	3.0	200	3000	0.25	5	62.2	55
1N4763A	1N4763A	86.45	91	95.55	2.0	250	3000	0.25	5	69.2	50
1N4764A	1N4764A	95.00	100	105.0	2.5	350	3000	0.25	5	76.0	45

Note : 5% tolerance of Zener voltage

Rating and characteristic curves (1N4728A THRU 1N4764A)

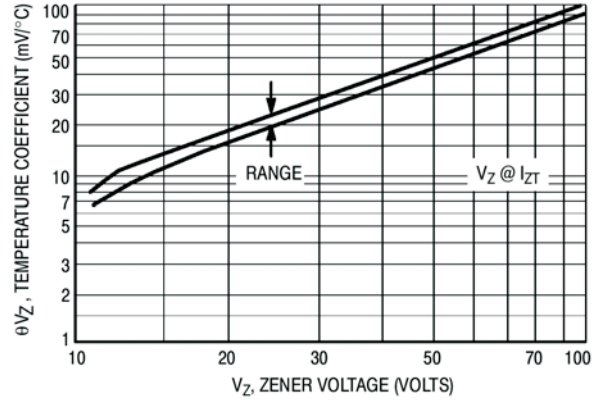
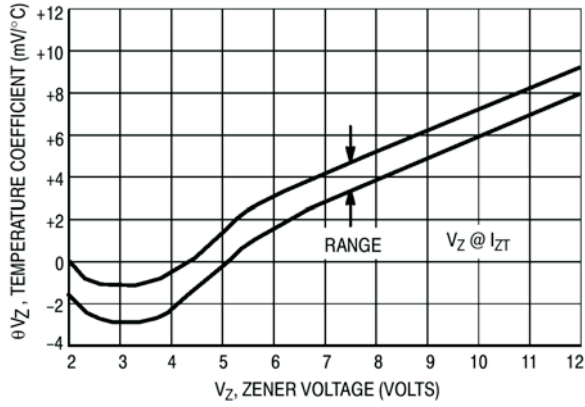

Figure 1. Temperature coefficients
(-55°C to $+150^\circ\text{C}$ temperature range; 90% of the units are in the ranges indicated.)

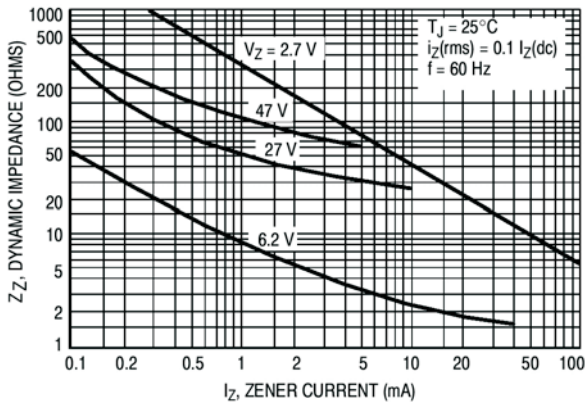

Figure 2. Effect of zener current on zener impedance

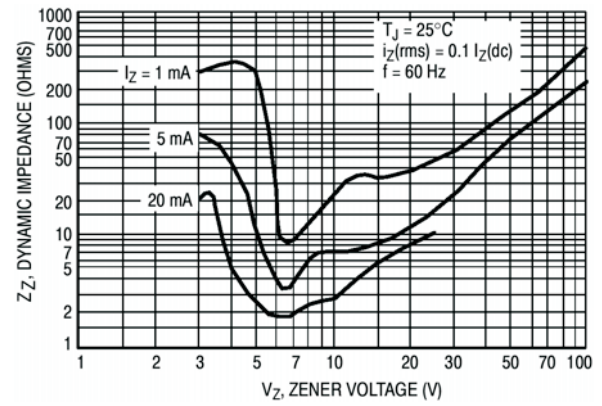



Figure 3. Effect of zener voltage on zener impedance

1N4728A THRU 1N4764A

Pinning information

Pin	Simplified outline	Symbol
Pin1 cathode Pin2 anode		

Taping & bulk specifications for AXIAL devices

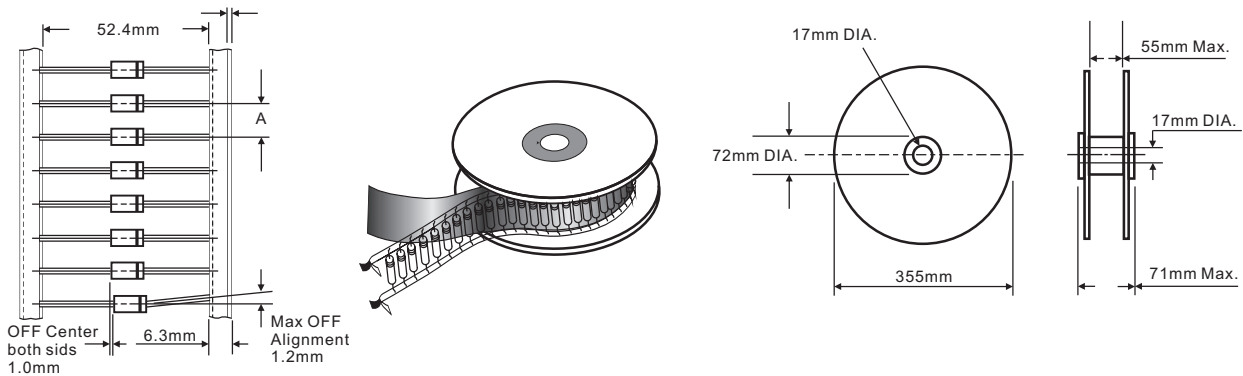

REEL PACKING

DEVICE CASE TYPE	Q'TY 1 (PCS / REEL)	COMPONENT SPACING "A" in FIG. A	CARTON SIZE (m/m)	Q'TY 2 (PCS / CARTON)	APPROX. CROSS WEIGHT(kg)
DO-41G	5,000	5 mm	360 * 340 * 370	20,000	10.8

AMMO PACKING

DEVICE CASE TYPE	Q'TY 1 (PCS / BOX)	INNER BOX SIZE (m/m)	CARTON SIZE (m/m)	Q'TY 2 (PCS / CARTON)	APPROX. CROSS WEIGHT(kg)
DO-41G/26mm	5,000	260 * 83 * 160	440 * 270 * 340	75,000	22.7
DO-41G/52mm	5,000	260 * 83 * 160	440 * 270 * 340	50,000	15.7

1N4728A THRU 1N4764A

BULK PACKING

DEVICE CASE TYPE	Q'TY 1 (PCS / BOX)	INNER BOX SIZE (m/m)	CARTON SIZE (m/m)	Q'TY 2 (PCS / CARTON)	APPROX. CROSS WEIGHT(kg)
DO-41G	1,000	194 * 84 * 20	465 * 220 * 260	50,000	20.6

Suggested thermal profiles for soldering processes

1. Lead free temperature profile wave-soldering

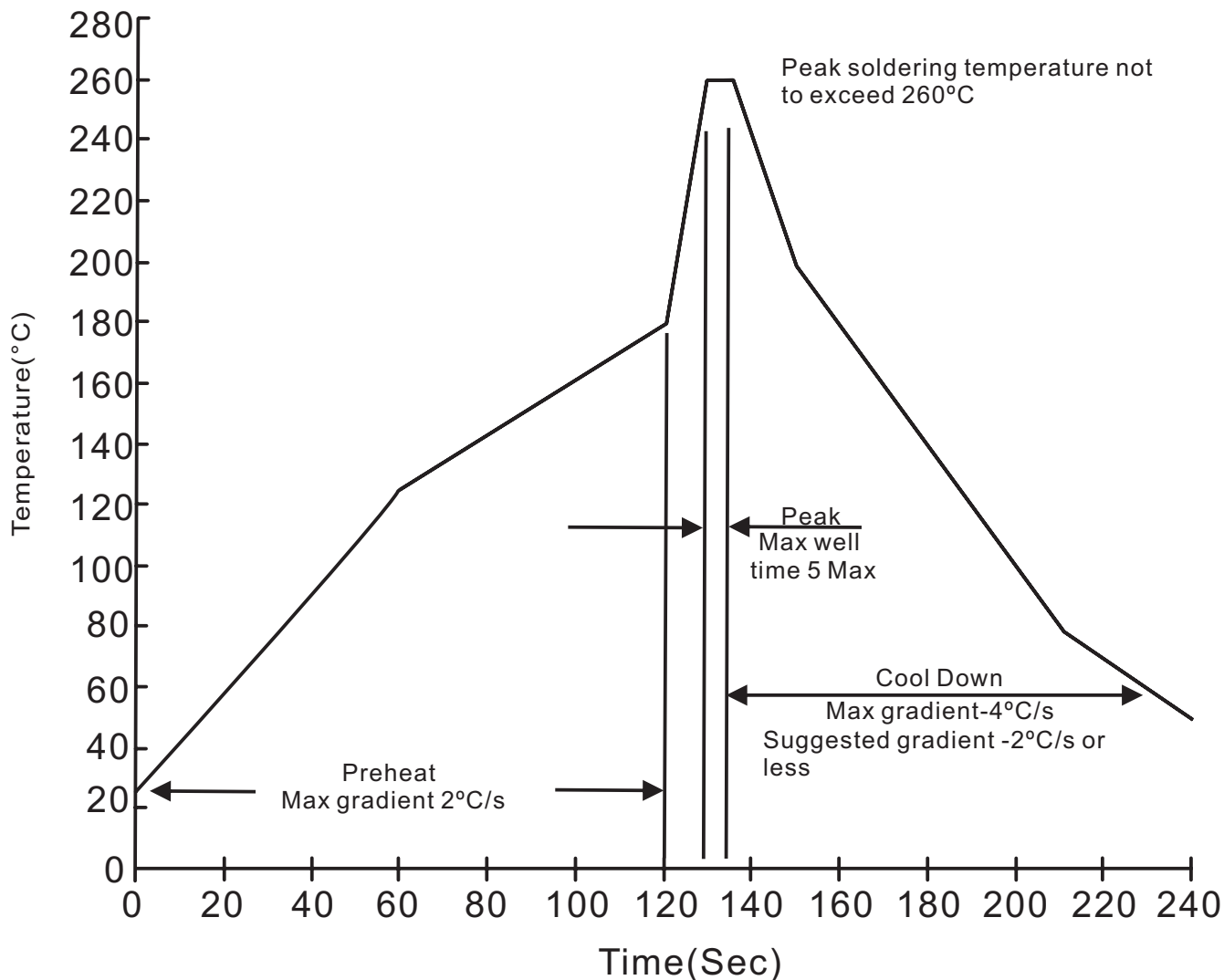

1N4728A THRU 1N4764A**High reliability test capabilities**

Item Test	Conditions	Reference
1. Solder Resistance	at 260±5°C for 10±2sec. immerse body into solder 1/16"±1/32"	MIL-STD-750D METHOD-2031
2. Solderability	at 245±5°C for 5 sec.	MIL-STD-202F METHOD-208
3. Pull Test	1kg in axial lead direction for 10 sec.	MIL-STD-750D METHOD-2036
4. Bend Lead	1kg weight applied to each lead bending arc 90°±5° for 3 times.	MIL-STD-750D METHOD-2036
5. High Temperature Reverse Bias	$V_R=80\%$ rate at $T_J=150^\circ\text{C}$ for 168 hrs.	MIL-STD-750D METHOD-1038
6. Pressure Cooker	15P _{SIG} at $T_A=121^\circ\text{C}$ for 4 hrs.	JESD22-A102
7. Temperature Cycling	-55°C to +125°C dwelled for 30 min. and transferred for 5min. total 10 cycles.	MIL-STD-750D METHOD-1051
8. Thermal Shock	0°C for 5 min. rise to 100°C for 5 min. total 10 cycles.	MIL-STD-750D METHOD-1056
9. Humidity	at $T_A=85^\circ\text{C}$, RH=85% for 1000hrs.	MIL-STD-750D METHOD-1021
10. High Temperature Storage Life	at 175°C for 1000 hrs.	MIL-STD-750D METHOD-1031