



DC COMPONENTS CO., LTD.

RECTIFIER SPECIALISTS

1N914

THRU

1N / 1N
4148 / 4454

TECHNICAL SPECIFICATIONS OF HIGH SPEED SWITCHING DIODES

VOLTAGE RANGE -50 to 100 Volts

CURRENT - 0.075 to 0.2 Ampere

FEATURES

- * Silicon epitaxial planar diodes
- * Low power loss, high efficiency
- * Low leakage
- * Low forward voltage
- * High speed switching
- * High current capability
- * High reliability

MECHANICAL DATA

- * Case: Glass sealed case
- * Lead: MIL-STD-202E, Method 208 guaranteed
- * Polarity: Color band denotes cathode end
- * Mounting position: Any
- * Weight: 0.13 gram

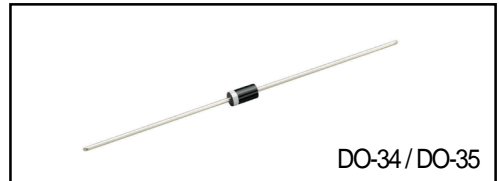

DO-34/DO-35

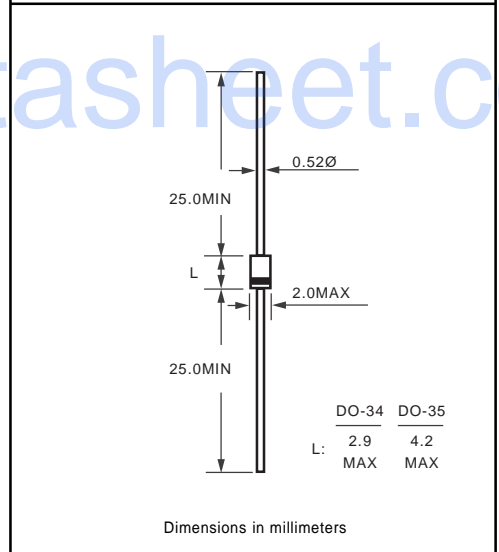

MAXIMUM RATINGS AND ELECTRICAL CHARACTERISTICS

Ratings at 25°C ambient temperature unless otherwise specified.
Single phase, half wave, 60 Hz, resistive or inductive load.
For capacitive load, derate current by 20%.

	SYMBOL	1N914	1N4148	1N4150	1N4151	1N4154	1N4448	1N4454	UNITS
Maximum Recurrent Peak Reverse Voltage	V _{RRM}	100	100	50	75	35	100	75	V
Maximum Average Rectified Current	I _o	75	150	200	150	150	150	150	mA
Maximum Power Dissipation Tamb=25°C	P _{tot}	250	500	500	500	500	500	500	mW
Maximum Forward Voltage	V _F	1.0/10	1.0/10	1.0/200	1.0/50	1.0/30	1.0/100	1.0/10	V/mA
Maximum Reverse Current	I _R	5000/75	5000/75	100/50	50/50	100/25	5000/75	100/10	nA/V
Maximum Reverse Recovery Time	t _{rr}	4.0	4.0	4.0	2.0	2.0	4.0	4.0	nS
Typical Junction Capacitance	C _J	4.0							pF
Operating and Storage Temperature Range	T _J , T _{STG}	-65 to +200							°C

NOTE: 1-1N914A, 1N914B IS SAME AS 1N914, EXCEPT DIFFERENT IN FORWARD VOLTAGE:

1N914A-1.0/20 V/mA

1N914B-1.0/100 V/mA

2. Suffix "M" stands for "DO-34" package. (e.g.: 1N4148M)

RATING AND CHARACTERISTIC CURVES

(1N914 THRU 1N4148
1N4454)

REF: 1N4148

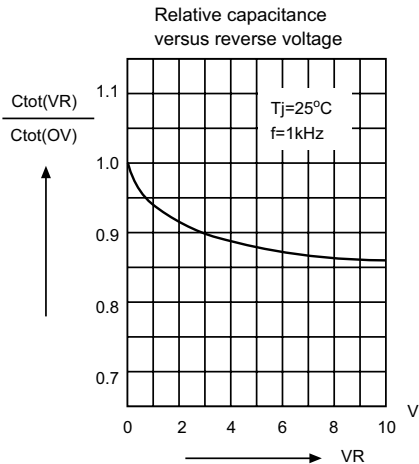
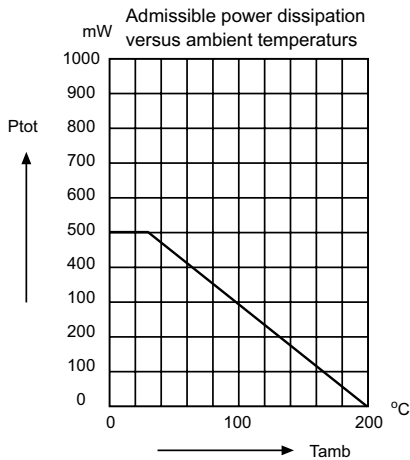
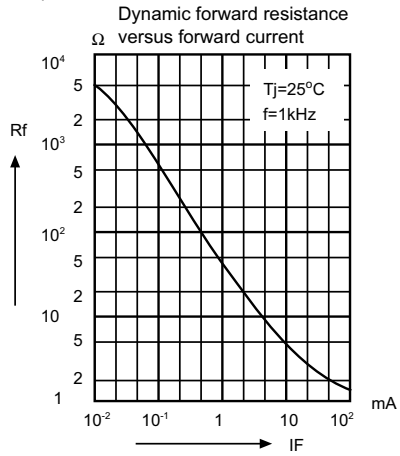
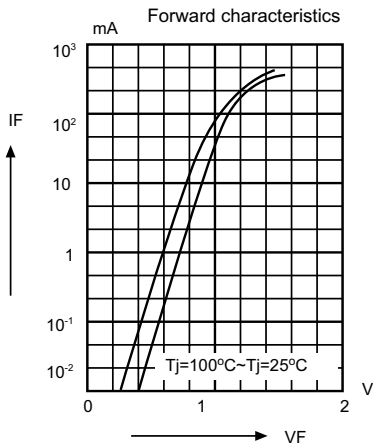
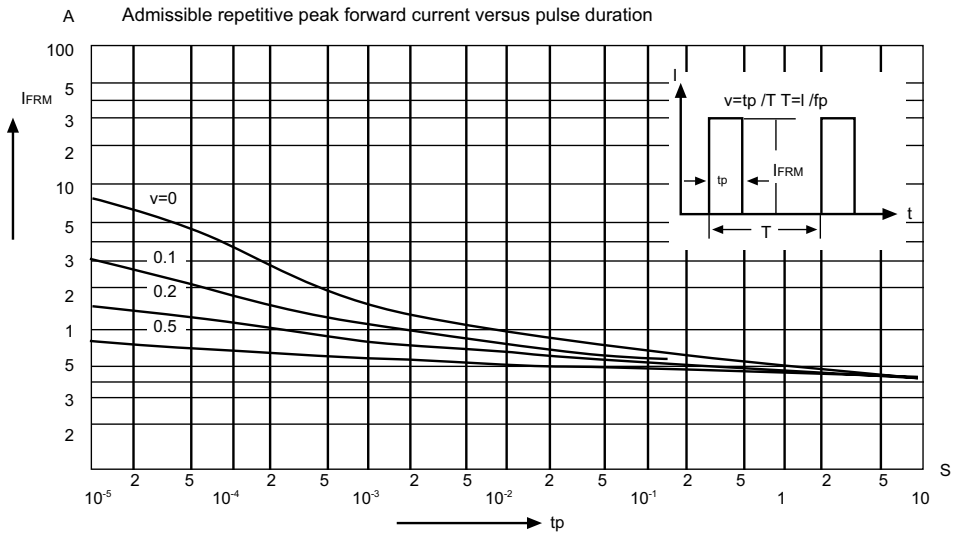

DC COMPONENTS CO., LTD.