

CRYSTAL OSCILLATOR (XO) (10 MHz TO 1.4 GHz)

Features

- Available with any-rate output frequencies from 10 MHz to 945 MHz and select frequencies to 1.4 GHz
- 3rd generation DSPLL[®] with superior jitter performance
- 3x better frequency stability than SAW-based oscillators
- Internal fixed crystal frequency ensures high reliability and low aging
- Available CMOS, LVPECL, LVDS, and CML outputs
- 3.3, 2.5, and 1.8 V supply options
- Industry-standard 5 x 7 mm package and pinout
- Pb-free/RoHS-compliant

Applications

- SONET/SDH
- Networking
- SD/HD video
- Test and measurement
- Clock and data recovery
- FPGA/ASIC clock generation

Description

The Si530/531 XO utilizes Silicon Laboratories' advanced DSPLL[®] circuitry to provide a low jitter clock at high frequencies. The Si530/531 is available with any-rate output frequency from 10 to 945 MHz and select frequencies to 1400 MHz. Unlike a traditional XO, where a different crystal is required for each output frequency, the Si530/531 uses one fixed crystal to provide a wide range of output frequencies. This IC based approach allows the crystal resonator to provide exceptional frequency stability and reliability. In addition, DSPLL clock synthesis provides superior supply noise rejection, simplifying the task of generating low jitter clocks in noisy environments typically found in communication systems. The Si530/531 IC based XO is factory configurable for a wide variety of user specifications including frequency, supply voltage, output format, and temperature stability. Specific configurations are factory programmed at time of shipment, thereby eliminating long lead times associated with custom oscillators.

Functional Block Diagram

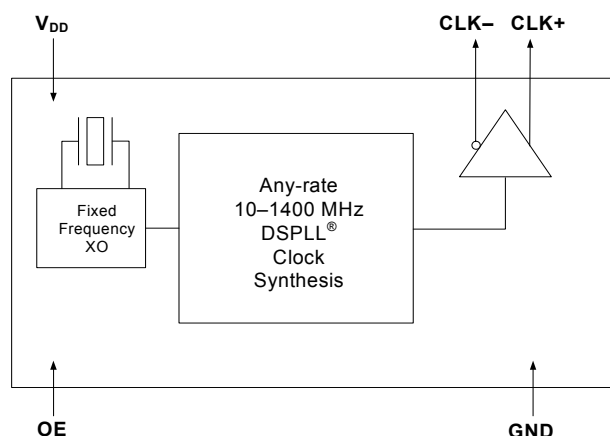

Ordering Information:

See page 7.

Pin Assignments:

See page 6.

(Top View)

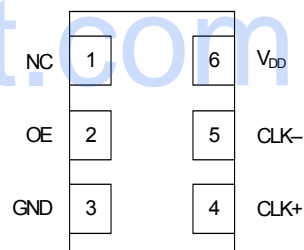

Si530 (LVDS/LVPECL/CML)

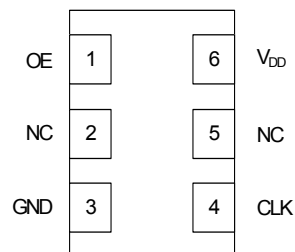

Si530 (CMOS)

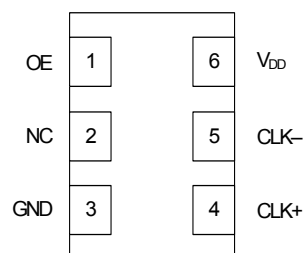

Si531 (LVDS/LVPECL/CML)

1. Electrical Specifications

Table 1. Recommended Operating Conditions

| Parameter | Symbol | Test Condition | Min | Typ | Max | Units |
|---------------------------------|-----------------|--------------------------|------------------------|-----|------|-------|
| Supply Voltage ¹ | V _{DD} | 3.3 V option | 2.97 | 3.3 | 3.63 | V |
| | | 2.5 V option | 2.25 | 2.5 | 2.75 | |
| | | 1.8 V option | 1.71 | 1.8 | 1.89 | |
| Supply Current | I _{DD} | Output enabled LVPECL | — | 111 | 121 | mA |
| | | CML | — | 99 | 108 | |
| | | LVDS | — | 90 | 98 | |
| | | CMOS | — | 81 | 88 | |
| | | Tristate mode | — | 60 | 75 | |
| Output Enable (OE) ² | | V _{IH} | 0.75 x V _{DD} | — | — | V |
| | | V _{IL} | — | — | 0.5 | |
| Operating Temperature Range | T _A | | −40 | — | 85 | °C |

Notes:

- Selectable parameter specified by part number. See Section 3. "Ordering Information" on page 7 for further details.
- OE pin includes a 17 kΩ pullup resistor to V_{DD}.

Table 2. CLK± Output Frequency Characteristics

| Parameter | Symbol | Test Condition | Min | Typ | Max | Units |
|--------------------------------------|----------------|--|-----|------|-----|-------|
| Nominal Frequency ^{1,2} | f _O | LVPECL/LVDS/CML | 10 | — | 945 | MHz |
| | | CMOS | 10 | — | 160 | |
| Initial Accuracy | f _i | Measured at +25 °C at time of shipping | — | ±1.5 | — | ppm |
| Temperature Stability ^{1,3} | | | −7 | — | +7 | ppm |
| | | | −20 | — | +20 | |
| | | | −50 | — | +50 | |
| Aging | f _a | Frequency drift over first year | — | — | ±3 | ppm |
| | | Frequency drift over 15 year life | — | — | ±10 | ppm |

Notes:

- See Section 3. "Ordering Information" on page 7 for further details.
- Specified at time of order by part number. Also available in frequencies from 970 to 1134 MHz and 1213 to 1417 MHz.
- Selectable parameter specified by part number.
- Time from powerup or tristate mode to f_O.

Table 2. CLK± Output Frequency Characteristics (Continued)

| Parameter | Symbol | Test Condition | Min | Typ | Max | Units |
|---------------------------|------------------|--------------------------|-----|-----|-------|-------|
| Total Stability | | Temp stability = ±7 ppm | — | — | ±20 | ppm |
| | | Temp stability = ±20 ppm | — | — | ±31.5 | ppm |
| | | Temp stability = ±50 ppm | — | — | ±61.5 | ppm |
| Powerup Time ⁴ | t _{OSC} | | — | — | 10 | ms |

Notes:

- See Section 3. "Ordering Information" on page 7 for further details.
- Specified at time of order by part number. Also available in frequencies from 970 to 1134 MHz and 1213 to 1417 MHz.
- Selectable parameter specified by part number.
- Time from powerup or tristate mode to f_O.

Table 3. CLK± Output Levels and Symmetry

| Parameter | Symbol | Test Condition | Min | Typ | Max | Units |
|-----------------------------------|---------------------------------|---|------------------------|------------------------|------------------------|-----------------|
| LVPECL Output Option ¹ | V _O | mid-level | V _{DD} - 1.42 | — | V _{DD} - 1.25 | V |
| | V _{OD} | swing (diff) | 1.1 | — | 1.9 | V _{PP} |
| | V _{SE} | swing (single-ended) | 0.55 | — | 0.95 | V _{PP} |
| LVDS Output Option ² | V _O | mid-level | 1.125 | 1.20 | 1.275 | V |
| | V _{OD} | swing (diff) | 0.5 | 0.7 | 0.9 | V _{PP} |
| CML Output Option ² | V _O | mid-level | — | V _{DD} - 0.75 | — | V |
| | V _{OD} | swing (diff) | 0.70 | 0.95 | 1.20 | V _{PP} |
| CMOS Output Option ³ | V _{OH} | I _{OH} = 32 mA | 0.8 x V _{DD} | — | V _{DD} | V |
| | V _{OL} | I _{OL} = 32 mA | — | — | 0.4 | |
| Rise/Fall time (20/80%) | t _R , t _F | LVPECL/LVDS/CML | — | — | 350 | ps |
| | | CMOS with C _L = 15 pF | — | 1 | — | ns |
| Symmetry (duty cycle) | SYM | LVPECL: V _{DD} - 1.3 V (diff) LVDS: 1.25 V (diff) CMOS: V _{DD} /2 | 45 | — | 55 | % |

Notes:

- 50 Ω to V_{DD} - 2.0 V.
- R_{term} = 100 Ω (differential).
- C_L = 15 pF

Table 4. CLK± Output Phase Jitter

| Parameter | Symbol | Test Condition | Min | Typ | Max | Units |
|---|----------------|---------------------------|-----|------|------|-------|
| Phase Jitter (RMS)* for F _{OUT} ≥ 500 MHz | ϕ _J | 12 kHz to 20 MHz (OC-48) | — | 0.25 | 0.40 | ps |
| | | 50 kHz to 80 MHz (OC-192) | — | 0.26 | 0.37 | |
| Phase Jitter (RMS)* for F _{OUT} of 125 to 500 MHz | ϕ _J | 12 kHz to 20 MHz (OC-48) | — | 0.36 | 0.50 | ps |
| | | 50 kHz to 20 MHz (OC-192) | — | 0.34 | 0.42 | |

***Note:** Differential Modes: LVPECL/LVDS/CML. Refer to AN256 for further information.

Table 5. CLK± Output Period Jitter

| Parameter | Symbol | Test Condition | Min | Typ | Max | Units |
|----------------|------------------|----------------|-----|-----|-----|-------|
| Period Jitter* | J _{PER} | RMS | — | 2 | — | ps |
| | | Peak-to-Peak | — | 14 | — | |

***Note:** Any output mode, including CMOS, LVPECL, LVDS, CML. N = 1000 cycles. Refer to AN279 for further information.

Table 6. CLK± Output Phase Noise (Typical)

| Offset Frequency (f) | 120.00 MHz LVDS | 156.25 MHz LVPECL | 622.08 MHz LVPECL | Units |
|----------------------|--------------------|----------------------|----------------------|--------|
| 100 Hz | -112 | -105 | -97 | dBc/Hz |
| 1 kHz | -122 | -122 | -107 | |
| 10 kHz | -132 | -128 | -116 | |
| 100 kHz | -137 | -135 | -121 | |
| 1 MHz | -144 | -144 | -134 | |
| 10 MHz | -150 | -147 | -146 | |
| 100 MHz | n/a | n/a | -148 | |

Table 7. Absolute Maximum Ratings¹

| Parameter | Symbol | Rating | Units |
|--|------------|------------------------|---------|
| Maximum Operating Temperature | T_{AMAX} | 85 | °C |
| Supply Voltage | V_{DD} | -0.5 to +3.8 | Volts |
| Input Voltage (any input pin) | V_I | -0.5 to $V_{DD} + 0.3$ | Volts |
| Storage Temperature | T_S | -55 to +125 | °C |
| ESD Sensitivity (HBM, per JESD22-A114) | ESD | 2500 | Volts |
| Soldering Temperature (Pb-free profile) ² | T_{PEAK} | 260 | °C |
| Soldering Temperature Time @ T_{PEAK} (Pb-free profile) ² | t_p | 20–40 | seconds |

Notes:

- Stresses beyond those listed in Absolute Maximum Ratings may cause permanent damage to the device. Functional operation or specification compliance is not implied at these conditions. Exposure to maximum rating conditions for extended periods may affect device reliability.
- The device is compliant with JEDEC J-STD-020C. Refer to Si5xx Packaging FAQ available for download at www.silabs.com/VCXO for further information, including soldering profiles.

Table 8. Environmental Compliance

The Si530/531 meets the following qualification test requirements.

| Parameter | Conditions/Test Method |
|------------------------|-------------------------------|
| Mechanical Shock | MIL-STD-883F, Method 2002.3 B |
| Mechanical Vibration | MIL-STD-883F, Method 2007.3 A |
| Solderability | MIL-STD-883F, Method 203.8 |
| Gross & Fine Leak | MIL-STD-883F, Method 1014.7 |
| Resistance to Solvents | MIL-STD-883F, Method 2016 |

2. Pin Descriptions

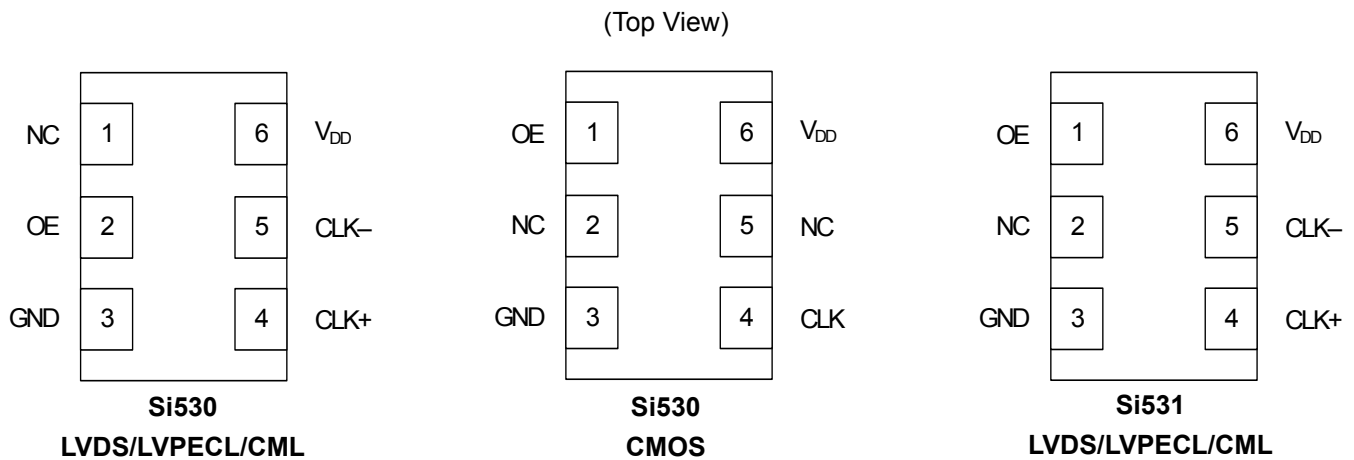

Table 9. Pinout for Si530 Series

| Pin | Symbol | LVDS/LVPECL/CML Function | CMOS Function |
|-----|-------------------------|--|--|
| 1 | OE (CMOS only)* | No connection | Output enable 0 = clock output disabled (outputs tristated) 1 = clock output enabled |
| 2 | OE (LVPECL, LVDS, CML)* | Output enable 0 = clock output disabled (outputs tristated) 1 = clock output enabled | No connection |
| 3 | GND | Electrical and Case Ground | Electrical and Case Ground |
| 4 | CLK+ | Oscillator Output | Oscillator Output |
| 5 | CLK- | Complementary Output | No connection |
| 6 | V _{DD} | Power Supply Voltage | Power Supply Voltage |

***Note:** OE includes a 17 kΩ pullup resistor to V_{DD}.

Table 10. Pinout for Si531 Series

| Pin | Symbol | LVDS/LVPECL/CML Function |
|-----|-------------------------|--|
| 1 | OE (LVPECL, LVDS, CML)* | Output enable 0 = clock output disabled (outputs tristated) 1 = clock output enabled |
| 2 | No connection | No connection |
| 3 | GND | Electrical and Case Ground |
| 4 | CLK+ | Oscillator Output |
| 5 | CLK- | Complementary output |
| 6 | V _{DD} | Power Supply Voltage |

***Note:** OE includes a 17 kΩ pullup resistor to V_{DD}.

3. Ordering Information

The Si530/531 XO supports a variety of options including frequency, temperature stability, output format, and V_{DD} . Specific device configurations are programmed into the Si530/531 at time of shipment. Configurations can be specified using the Part Number Configuration chart below. Silicon Laboratories provides a web browser-based part number configuration utility to simplify this process. Refer to www.silabs.com/VCXOPartNumber to access this tool and for further ordering instructions. The Si530 and Si531 XO series are supplied in an industry-standard, RoHS compliant, 6-pad, 5 x 7 mm package. The Si531 Series supports an alternate OE pinout (pin #1) for the LVPECL, LVDS, and CML output formats. See Tables 9 and 10 for the pinout differences between the Si530 and Si531 series.

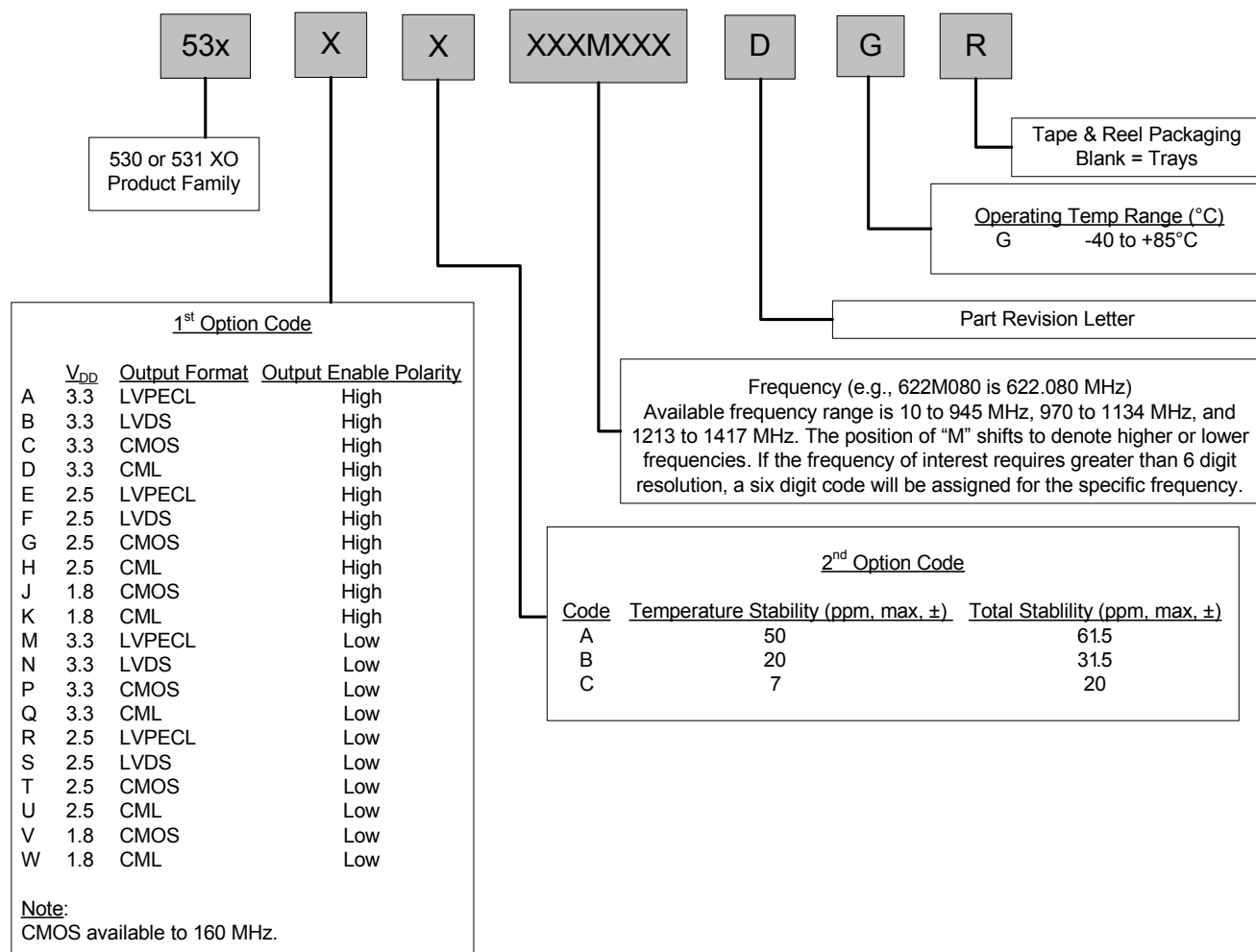

Example P/N: 530AB622M080DGR is a 5 x 7 XO in a 6 pad package. The frequency is 622.080 MHz, with a 3.3 V supply, LVPECL output, and Output Enable active high polarity. Temperature stability is specified as ± 20 ppm. The part is specified for -40 to $+85$ $^{\circ}$ C ambient temperature range operation and is shipped in tape and reel format.

Figure 1. Part Number Convention

4. Outline Diagram and Suggested Pad Layout

Figure 2 illustrates the package details for the Si530/531. Table 11 lists the values for the dimensions shown in the illustration.

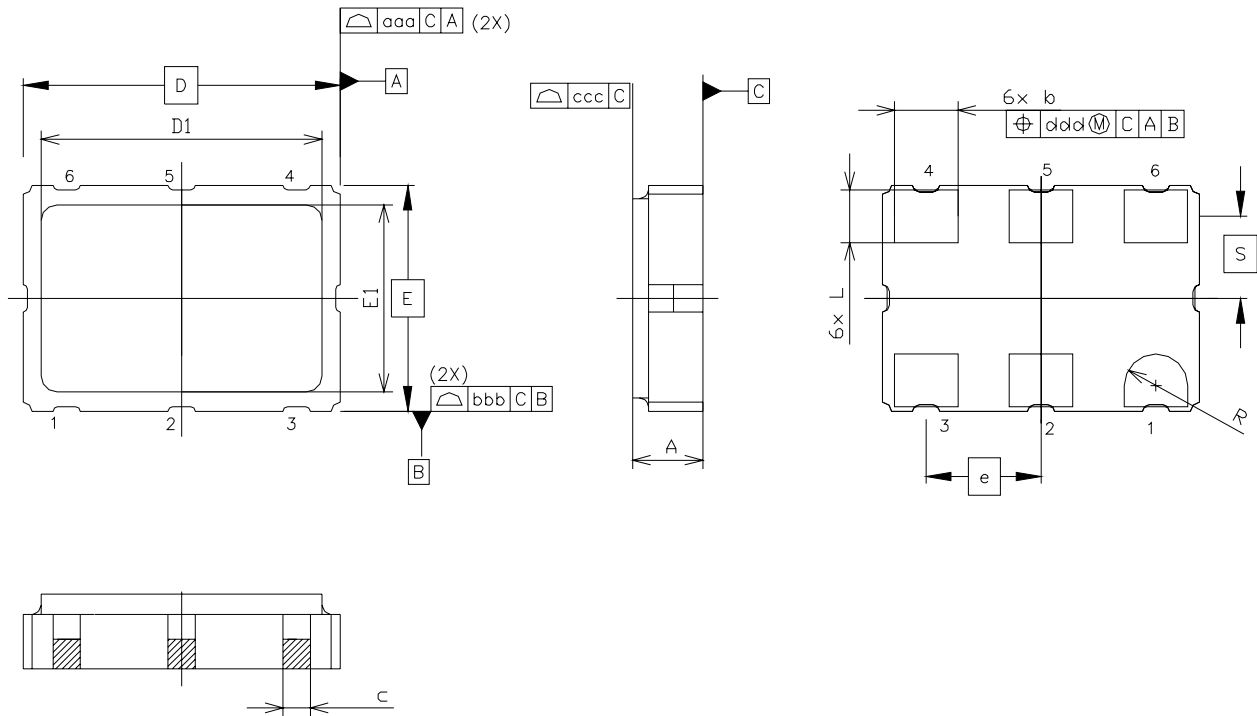

Figure 2. Si530/531 Outline Diagram

Table 11. Package Diagram Dimensions (mm)

| Dimension | Min | Nom | Max |
|-----------|------------|------|------|
| A | 1.45 | 1.65 | 1.85 |
| b | 1.2 | 1.4 | 1.6 |
| c | 0.60 TYP. | | |
| D | 7.00 BSC. | | |
| D1 | 6.10 | 6.2 | 6.30 |
| e | 2.54 BSC. | | |
| E | 5.00 BSC. | | |
| E1 | 4.30 | 4.40 | 4.50 |
| L | 1.07 | 1.27 | 1.47 |
| S | 1.815 BSC. | | |
| R | 0.7 REF. | | |
| aaa | — | — | 0.15 |
| bbb | — | — | 0.15 |
| ccc | — | — | 0.10 |
| ddd | — | — | 0.10 |

5. Si530/Si531 Mark Specification

Figure 3 illustrates the mark specification for the Si530/Si531. Table 12 lists the line information.

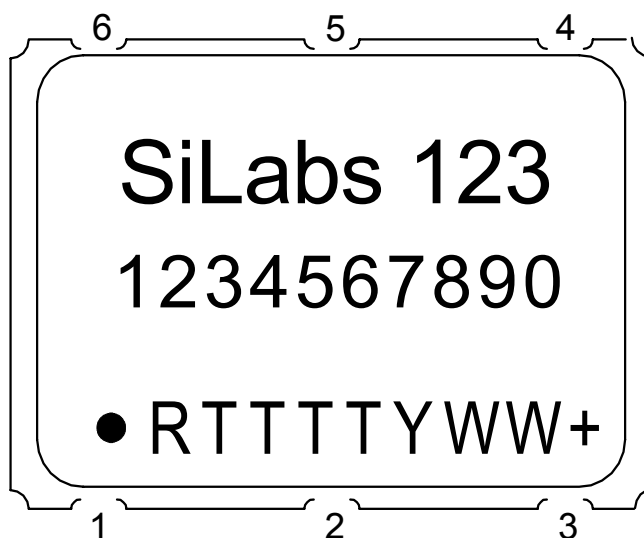

Figure 3. Mark Specification

Table 12. Si53x Top Mark Description

| Line | Position | Description |
|------|-------------------|--|
| 1 | 1–10 | “SiLabs”+ Part Family Number, 5xx (First 3 characters in part number) |
| 2 | 1–10 | Si530, Si531: Option1 + Option2 + Freq(7) + Temp Si532, Si533, Si534, Si530/Si531 w/ 8-digit resolution: Option1 + Option2 + ConfigNum(6) + Temp |
| 3 | Trace Code | |
| | Position 1 | Pin 1 orientation mark (dot) |
| | Position 2 | Product Revision (D) |
| | Position 3–6 | Tiny Trace Code (4 alphanumeric characters per assembly release instructions) |
| | Position 7 | Year (least significant year digit), to be assigned by assembly site (ex: 2007 = 7) |
| | Position 8–9 | Calendar Work Week number (1–53), to be assigned by assembly site |
| | Position 10 | “+” to indicate Pb-Free and RoHS-compliant |

6. 6-Pin PCB Land Pattern

Figure 4 illustrates the 6-pin PCB land pattern for the Si530/531. Table 13 lists the values for the dimensions shown in the illustration.

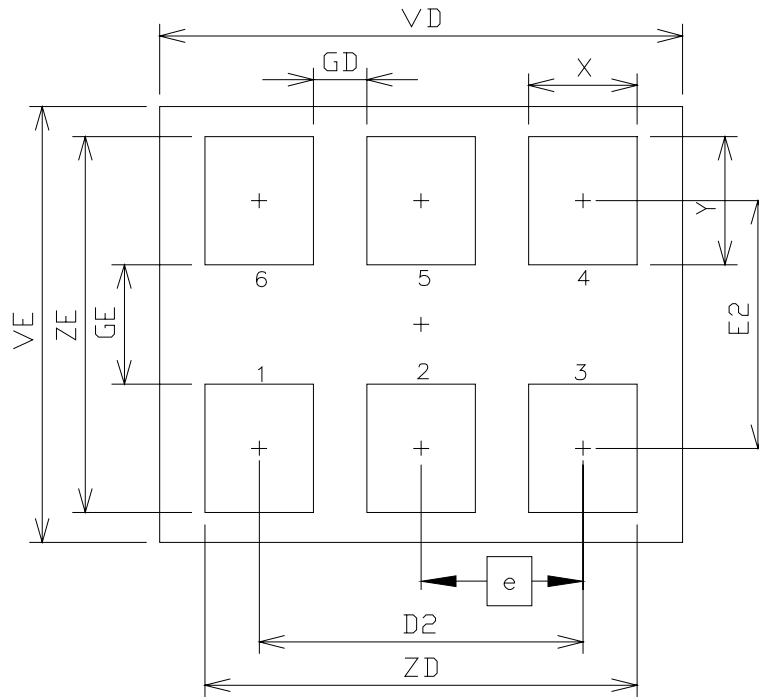

Figure 4. Si530/531 PCB Land Pattern

Table 13. PCB Land Pattern Dimensions (mm)

| Dimension | Min | Max |
|-----------|------|----------|
| D2 | | 5.08 REF |
| e | | 2.54 BSC |
| E2 | | 4.15 REF |
| GD | 0.84 | — |
| GE | 2.00 | — |
| VD | | 8.20 REF |
| VE | | 7.30 REF |
| X | | 1.70 TYP |
| Y | | 2.15 REF |
| ZD | — | 6.78 |
| ZE | — | 6.30 |

Notes:

1. Dimensioning and tolerancing per the ANSI Y14.5M-1994 specification.
2. Land pattern design based on IPC-7351 guidelines.
3. All dimensions shown are at maximum material condition (MMC).
4. Controlling dimension is in millimeters (mm).

DOCUMENT CHANGE LIST

Revision 0.4 to Revision 0.5

- Updated Table 1, “Recommended Operating Conditions,” on page 2.
 - Added maximum supply current specifications.
 - Specified relationship between temperature at startup and operation temperature.
- Updated Table 4, “CLK± Output Phase Jitter,” on page 4 to include maximum rms jitter generation specifications and updated typical rms jitter specifications.
- Added Table 6, “CLK± Output Phase Noise (Typical),” on page 4.
- Added Output Enable active polarity as an option in Figure 1, “Part Number Convention,” on page 7.

Revision 0.5 to Revision 1.0

- Updated Note 3 in Table 1, “Recommended Operating Conditions,” on page 2.
- Updated Figure 1, “Part Number Convention,” on page 7.

Revision 1.0 to Revision 1.1

- Updated Table 1, “Recommended Operating Conditions,” on page 2.
 - Device maintains stable operation over –40 to +85 °C operating temperature range.
 - Supply current specifications updated for revision D.
- Updated Table 2, “CLK± Output Frequency Characteristics,” on page 2.
 - Added specification for ±20 ppm lifetime stability (±7 ppm temperature stability) XO.
- Updated Table 3, “CLK± Output Levels and Symmetry,” on page 3.
 - Updated LVDS differential peak-peak swing specifications.
- Updated Table 4, “CLK± Output Phase Jitter,” on page 4.
- Updated Table 5, “CLK± Output Period Jitter,” on page 4.
 - Revised period jitter specifications.
- Updated Table 7, “Absolute Maximum Ratings¹,” on page 5 to reflect the soldering temperature time at 260 °C is 20–40 sec per JEDEC J-STD-020C.
- Updated 3. “Ordering Information” on page 7.
 - Changed ordering instructions to revision D.
- Added 5. “Si530/Si531 Mark Specification” on page 9.

CONTACT INFORMATION

Silicon Laboratories Inc.

400 West Cesar Chavez
Austin, TX 78701
Tel: 1+(512) 416-8500
Fax: 1+(512) 416-9669
Toll Free: 1+(877) 444-3032
Email: VCXOinfo@silabs.com
Internet: www.silabs.com

The information in this document is believed to be accurate in all respects at the time of publication but is subject to change without notice. Silicon Laboratories assumes no responsibility for errors and omissions, and disclaims responsibility for any consequences resulting from the use of information included herein. Additionally, Silicon Laboratories assumes no responsibility for the functioning of undescribed features or parameters. Silicon Laboratories reserves the right to make changes without further notice. Silicon Laboratories makes no warranty, representation or guarantee regarding the suitability of its products for any particular purpose, nor does Silicon Laboratories assume any liability arising out of the application or use of any product or circuit, and specifically disclaims any and all liability, including without limitation consequential or incidental damages. Silicon Laboratories products are not designed, intended, or authorized for use in applications intended to support or sustain life, or for any other application in which the failure of the Silicon Laboratories product could create a situation where personal injury or death may occur. Should Buyer purchase or use Silicon Laboratories products for any such unintended or unauthorized application, Buyer shall indemnify and hold Silicon Laboratories harmless against all claims and damages.

Silicon Laboratories, Silicon Labs, and DSPLL are trademarks of Silicon Laboratories Inc.
Other products or brandnames mentioned herein are trademarks or registered trademarks of their respective holders.